

# LOCKSMITH'S GUIDE 2019

*to Adaptors and Optionals for Keyline Machines*



**KEYLINE**

*Innovators by design | Since 1770*

A BIANCHI 1770 GROUP COMPANY



THE ART OF  
*DUPLICATION*





# **THE LOCKSMITH'S GUIDE**

## **2019**

to Adaptors and Optionals  
for Keyline Machines



# INDEX / INDICE

The Locksmith's Guide 2019

p	VI
	VIII
	XLII
	XLIV
	XLV
	XLVII
	L
	LI
	LIII
	LIV

<b>Key Reader</b>
<b>Key Cutting Machines / Duplicatrici</b>
<b>884 Decryptor Mini</b>
<b>Bluetooth &amp; Power Adaptor</b>
<b>884 Decryptor Ultegra</b>
<b>Keyline Keyless Systems</b>
<b>Keyline TV</b>
<b>Keycenter</b>
<b>Technical Illustrations and Symbols / Illustrazioni Tecniche e Segni Convenzionali</b>
<b>Symbols / Simbologie</b>

p	1
	161
	247
	254
	264
	268
	280
	285

<b>Cylinder Keys / Chiavi Cilindro</b>
<b>Car Keys, Truck Keys, Accessories / Chiavi Auto, Chiavi Camion, Accessori</b>
<b>Cold Forged Keys, Double Bit and Pump Keys / Chiavi Patent, Chiavi a Doppia Mappa e Pompa</b>
<b>Cruciform Keys, Mail Box Keys, Tubular Keys / Chiavi a Croce, Per Casellari Postali, Tubolari</b>
<b>Optional Generic Accessories / Accessori Generici Opzionali</b>
<b>Quick Guide to Laser Key Systems / Guida Veloce ai Sistemi Chiavi Laser</b>
<b>Cutters / Frese</b>
<b>Application Index / Indice per Utilizzo</b>

# INTRO

The Locksmith's Guide 2019

*The Art of Duplication* is the new motto that summarizes Keyline's vision and the constant commitment to creating high-tech tools for talented locksmiths. The new edition of the **2019 Locksmith Guide** is a daily reference tool to be used to navigate the wide world of Keyline.

This is a unique guidebook for the sector that makes the management of spare parts, adapters and optional accessories easy and fast. Starting from a type of key, either residential or automotive, the catalogue will show the necessary mechanical support to duplicate with every Keyline key cutting machine. A complete, clear and well organized volume for fast and clear choices.

The **2019 Locksmith Guide** is part of the Keyline evolution towards a smarter world. A corporate history that dates back to 1770 and that has been constantly improving the work of professional locksmiths in all sectors.

**Massimo Bianchi, Keyline Strategic Planner**

*L'Arte della Duplicazione*, il nuovo motto che sintetizza gli orizzonti di Keyline, racchiude l'impegno costante a creare strumenti di alta tecnologia per il talento degli specialisti. E la nuova edizione della **Guida dello Specialista 2019** è lo strumento di consultazione quotidiana per orientarsi nel vasto mondo Keyline.

Una guida unica nel suo genere che rende semplice e veloce muoversi tra ricambi, adattatori e opzionali. A partire dal tipo di chiave, residenziale e automotive, si troveranno indicati i supporti meccanici necessari alla duplicazione con ogni macchina Keyline. Un volume completo, chiaro e ben organizzato, per una scelta rapida e sicura.

La **Guida dello Specialista 2019** è parte dell'evoluzione Keyline per un mondo più smart. Una storia nata nel 1770 e cresciuta migliorando ogni giorno in ogni ambito il lavoro degli specialisti.

**Massimo Bianchi, Keyline Strategic Planner**



# CAMILLO BIANCHI

For edge cut and dimple keys / Per chiavi piatte e punzonate



- STURDY, RAPID AND PRECISE
- DATABASES DIFFERENT BY REGION
- INTUITIVE INTERFACE
- CUSTOMIZED DATABASE SET-UP WITH SELF ACQUISITION FUNCTION\*
- AUTOMATIC SOFTWARE UPDATES



- SOLIDO, RAPIDO E PRECISO
- DIFFERENTI DATABASE PER AREA GEOGRAFICA
- INTERFACCIA INTUITIVA
- CREAZIONE DATABASE PERSONALIZZATO TRAMITE FUNZIONE DI AUTO-APPRENDIMENTO\*
- AGGIORNAMENTI SOFTWARE AUTOMATICI



## Door keys



## Car keys





---

## TECHNICAL FEATURES

Voltage	12V - 24W
External Connections	1 USB; 1 LAN
Dimensions	Width: 150 mm / Depth: 300 mm (330 mm with cables) / Height: 300 mm
Weight	4.5 Kg

---

---

## CARATTERISTICHE TECNICHE

Tensione Elettrica	12V - 24W
Connessioni Esterne	1 USB; 1 LAN
Dimensioni	Larghezza: 150 mm / Profondità: 300 mm (330 mm con cavi) / Altezza: 300 mm
Peso	4,5 Kg

---

\* Function to be purchased separately.  
\* Funzione acquistabile separatamente.



# NINJA TOTAL

For edge cut, laser and dimple keys / Per chiavi piatte, laser e punzonate



- ALL-IN ONE SOLUTION, WITH A DOUBLE CUTTING STATION
- HIGH-SPEED KEY CUTTING
- NEW C30 CLAMP
- INDUSTRIAL CONSOLE WITH THE KEYLINE LIGER SOFTWARE
- HEAD ENGRAVING FUNCTION
- PATENTED AND RELIABLE TECHNOLOGY



- SOLUZIONE ALL-IN ONE, CON DOPPIA STAZIONE DI TAGLIO
- ALTA VELOCITÀ NEL TAGLIO CHIAVI
- NUOVO MORSETTO C30
- CONSOLE INDUSTRIALE CON SOFTWARE LIGER KEYLINE
- FUNZIONE GRAVATURA TESTE
- TECNOLOGIA AFFIDABILE E BREVETTATA



## Door keys



## Car keys



Ford and Jaguar  
Ford e Jaguar

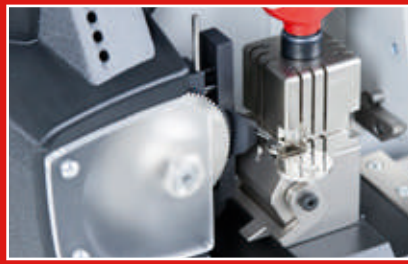

## TECHNICAL FEATURES

Power Supply	90-130V 50-60Hz / 220-240V 50-60Hz
Electronic Equipment	Mainboard with ARM Cortex A8 CPU, 256 MB RAM, NAND 1 GB memory, high resolution axes control
External Connections	2 USB 2.0 ports; 2 RS232 serial ports; 1 LAN port
Lighting	2 led strips - lighted cutting bay
Movements/Axes	3 stepper motor-operated axes

### EDGE CUT KEY SIDE

### DIMPLE KEY AND LASER KEY SIDE

Key Reading/Decoding System	Mechanical tracer with linear sensor	Electric contact
Clamps	4 faces (supplementary clamps are available for specific markets)	C30
Gauge	Automatic gauge unlock through the movement of the axes	
Motor	Asynchronous, 0.18 kW	DC electronic motor
Cutter	In Widia ø 63 mm	In Widia
Cutter Speed	1500-3000 rpm (variable speed according to the programmes)	13000 rpm
Absorption	250W (35W in stand-by)	
Dimensions	Width: 340 mm / Depth: 415 mm / Height: 300 mm	
Weight	30 Kg	

## CONSOLE TECHNICAL FEATURES

Power Supply	DC 24V (fed by the key cutting machine)
User Interface	7" industrial colour touch screen, 16:10, resolution 800x480 px, VGA

## CARATTERISTICHE TECNICHE

Alimentazione	90-130V 50-60Hz / 220-240V 50-60Hz
Dotazione Elettronica	Mainboard con CPU ARM Cortex A8, 256 MB RAM, memoria NAND 1 GB, controllo assi ad alta risoluzione
Connessioni Esterne	2 porte USB; 2 porte seriali RS232; 1 LAN
Illuminazione	Area di lavoro illuminata con 2 strisce led
Movimenti/Assi	3 assi pilotati da motori passo passo

### LATO CHIAVI PIATTE

### LATO CHIAVI PUNZONATE E LASER

Sistema di Lettura/Decodifica Chiave	Tastatore meccanico con sensore lineare	Contatto elettrico
Morsetti	4 facce (sono disponibili ulteriori morsetti per mercati specifici)	C30
Calibro	Sblocco calibro automatico tramite movimento assi	
Motore	Asincrono 0,18 kW	Elettronico DC
Fresa	In Widia ø 63 mm	In Widia
Velocità Fresa	1500-3000 rpm (velocità variabile a seconda dei programmi)	13000 rpm
Assorbimento	250W (35W in stand-by)	
Dimensioni	Larghezza: 340 mm / Profondità: 415 mm / Altezza: 300 mm	
Peso	30 Kg	

## CARATTERISTICHE TECNICHE CONSOLE

Alimentazione	DC 24V (alimentata dalla duplicatrice)
Interfaccia Utente	Schermo touch screen industriale a colori, 7", 16:10, risoluzione 800x480 px, VGA

\*More versions for specific markets are available.  
 \*Disponibili ulteriori versioni per i mercati specifici.



# NINJA

For edge cut and cruciform keys / Per chiavi piatte e a croce



- |  |   |
|--|---|
| ▪ ELECTRONIC AND AUTOMATIC                         | ▪ ELETTRONICA E AUTOMATICA                    |
| ▪ COMPACT DESIGN                                   | ▪ DESIGN COMPATTO                             |
| ▪ INTERACTIVE INTERFACE                            | ▪ INTERFACCIA INTERATTIVA                     |
| ▪ MULTIPLE CUTTING SPEEDS                          | ▪ VELOCITÀ DI TAGLIO MULTIPLE                 |
| ▪ UNLIMITED DATABASE WITH ON BOARD CROSS REFERENCE | ▪ DATABASE ILLIMITATO CON COMPARATIVO A BORDO |
| ▪ HERMETIC CUTTING BAY                             | ▪ AREA DI TAGLIO ERMETICA                     |

---

Door keys



---

Car keys





## TECHNICAL FEATURES

Power Supply	90-130V 50-60Hz / 220-240V 50-60Hz
Electronic Equipment	Mainboard with ARM Cortex A8 CPU, 256 MB RAM, NAND 1 GB memory, high resolution axes control
External Connections	2 USB 2.0 ports; 2 RS232 serial ports; 1 LAN port
Key Reading/Decoding System	Electric contact
Lighting	LED - lighted cutting bay
Movements/Axes	2 stepper motor-operated axes
Clamps	4 faces (supplementary clamps are available for specific markets)
Gauge	Automatic gauge unlock through the movement of the axes
Motor	Asynchronous, 0.18 kW
Cutter	In Widia $\varnothing$ 63 mm
Cutter Speed	1500-3000 rpm (variable speed according to the programmes)
Absorption	250W (35W in stand-by)
Dimensions	Width: 340 mm / Depth: 415 mm / Height: 300 mm
Weight	20 Kg

## CONSOLE TECHNICAL FEATURES

Power Supply	DC 24V (fed by the key cutting machine)
User Interface	7" industrial color touch screen, 16:10, resolution 800x480 px, VGA, quick duplication button

## CARATTERISTICHE TECNICHE

Alimentazione	90-130V 50-60Hz / 220-240V 50-60Hz
Dotazione Elettronica	Mainboard con CPU ARM Cortex A8, 256 MB RAM, memoria NAND 1 GB, controllo assi ad alta risoluzione
Conessioni Esterne	2 porte USB; 2 porte seriali RS232; 1 LAN
Sistema di Lettura/Decodifica Chiave	Contatto elettrico
Illuminazione	Area di lavoro illuminata a LED
Movimenti/Assi	2 assi pilotati da motori passo passo
Morsetti	4 facce (sono disponibili ulteriori morsetti per mercati specifici)
Calibro	Sblocco calibro automatico tramite movimento assi
Motore	Asincrono 0,18 kW
Fresa	In Widia $\varnothing$ 63 mm
Velocità Fresa	1500-3000 rpm (velocità variabile a seconda dei programmi)
Assorbimento	250W (35W in stand-by)
Dimensioni	Larghezza: 340 mm / Profondità: 415 mm / Altezza: 300 mm
Peso	20 Kg

## CARATTERISTICHE TECNICHE CONSOLE

Alimentazione	DC 24V (alimentata dalla duplicatrice)
Interfaccia Utente	Schermo touch screen industriale a colori, 7", 16:10, risoluzione 800x480 px, VGA, tasto copia veloce

\*More versions for specific markets are available.

\*Disponibili ulteriori versioni per i mercati specifici.



# DEZMO

For edge cut and cruciform keys / Per chiavi piatte e a croce



- OPTICAL READING
- INTERACTIVE INTERFACE
- MULTIPLE CUTTING SPEEDS
- UNLIMITED DATABASE WITH ON BOARD CROSS REFERENCE
- CARD MAKER
- UNIVERSAL ELECTRONIC FEEDER (INDEPENDENT)

- LETTURA OTTICA
- INTERFACCIA INTERATTIVA
- VELOCITÀ DI TAGLIO MULTIPLE
- DATABASE ILLIMITATO CON COMPARATIVO A BORDO
- CARD MAKER
- CARICATORE UNIVERSALE ELETTRONICO (INDIPENDENTE)

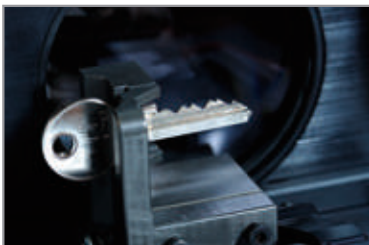

## Door keys



## Car keys



## TECHNICAL FEATURES

Power Supply	90-130V 50-60Hz / 220-240V 50-60Hz
User Interface	7" industrial color touch screen, 16:10, resolution 800x480 px, VGA
Electronic Equipment	Mainboard with 600 MHz CPU GEODE, 512 MB RAM, static memory on 4 GB compact flash, high resolution axes control
External Connections	2 USB ports; 1 LAN /Ethernet port; 1 VGA socket
Key Reading/Decoding System	Static reading from digital image (Optical + CCD)
Movements/Axes	2 stepper motor-operated axes
Clamps	4-faces (electronic identification of the cutting side in Dezmo Open and Dezmo Advance)
Gauge	Automatic in Dezmo Open and Dezmo Advance
Motor	Brushless
Cutter	In Widia $\varnothing$ 80 mm
Cutter Speed	2000-3000 rpm (variable speed according to the programmes)
Absorption	Dezmo basic: 400W (75W in stand-by); Dezmo Advance: 400W (100W in stand-by)
Dimensions	Width: 525 mm / Depth: 500 mm / Height: 450 mm
Weight	45 Kg

## FEEDER TECHNICAL FEATURES

Feeder Insertion	Can be integrated in Dezmo Open
Feeder Activated by	Electric motors
Key Installation in the Feeder	No tags (only stacker adjustment)
Key Thickness	Min 1.8 mm - Max 4.0 mm
Length and Width of the Blade	Length: Min 20 - Max 40 mm; Width: Min 6 - Max 10 mm
Length and Width of the Head	Length: Min 15 - Max 40 mm; Width: Min 15 - Max 42 mm
Number of Keys in the Stacker	60 (2.2 mm - thickness)
Key Positioning	Automatic positioning on A or B side according to key dimensions
Total Dimensions of the Machine with its Feeder	Width: 885 mm / Depth: 500 mm / Height: 450 mm
Weight	20 Kg

## CARATTERISTICHE TECNICHE

Alimentazione	90-130V 50-60Hz / 220-240V 50-60Hz
Interfaccia Utente	Schermo touchscreen industriale a colori, 7", 16:10, risoluzione 800x480 px, VGA
Dotazione Elettronica	Mainboard con CPU GEODE a 600 MHz, 512 MB RAM, memoria statica su compact flash 4 GB, controllo assi ad alta risoluzione
Conessioni Esterne	2 porte USB; 1 porta LAN/Ethernet; 1 porta VGA
Sistema di Lettura/Decodifica Chiave	Letture statica da immagine digitale (Ottica+CCD)
Movimenti/Assi	2 assi pilotati da motori passo passo
Morsetti	4 facce (riconoscimento elettronico del lato di taglio in Dezmo Open e Dezmo Advance)
Calibro	Automatico in Dezmo Open e Dezmo Advance
Motore	Brushless
Fresa	In Widia $\varnothing$ 80 mm
Velocità Fresa	2000-3000 rpm (velocità variabile a seconda dei programmi)
Assorbimento	Dezmo base: 400W (75W in stand-by); Dezmo Advance: 400W (100W in stand-by)
Dimensioni	Larghezza: 525 mm / Profondità: 500 mm / Altezza: 450 mm
Peso	45 Kg

## CARATTERISTICHE TECNICHE CARICATORE

Applicazione del Caricatore	Integrabile con Dezmo Open
Caricatore attivato da	Motori elettrici
Installazione delle Chiavi nel Caricatore	No piastrine (solo regolazione dell'impilatore)
Spessore Chiavi	Min 1,8 mm - Max 4,0 mm
Lunghezza e Larghezza della Canna	Lunghezza: Min 20 - Max 40 mm; Larghezza: Min 6 - Max 10 mm
Lunghezza e Larghezza della Testa	Lunghezza: Min 15 - Max 40 mm; Larghezza: Min 15 - Max 42 mm
Numero di Chiavi nell'Impilatore	60 (2,2 mm - spessore)
Posizionamento Chiave	Posizionamento automatico sul lato A o B a seconda delle dimensioni della chiave
Dimensioni Totali della Macchina con Caricatore	Larghezza: 885 mm / Profondità: 500 mm / Altezza: 450 mm
Peso	20 Kg

Dezmo is available in three versions:

- **Dezmo** – stand alone version;
- **Dezmo Open** – equipped for the installation of the robotized feeder;
- **Dezmo Advance** – version with an integrated robotized feeder.

Dezmo è disponibile in tre versioni:

- **Dezmo** – versione stand alone;
- **Dezmo Open** – predisposta per l'installazione del caricatore robotizzato;
- **Dezmo Advance** – versione integrata con caricatore robotizzato.

\*More versions for specific markets are available.  
\*Disponibili ulteriori versioni per i mercati specifici.



# NINJA LASER

For edge cut and laser keys / Per chiavi piatte e laser



- |  |   |   |   |
|--|---|---|---|
| <ul style="list-style-type: none"> <li>▪ ELECTRONIC AND AUTOMATIC</li> <li>▪ COMPACT DESIGN</li> <li>▪ INTERACTIVE INTERFACE</li> <li>▪ UNLIMITED DATABASE WITH ON BOARD CROSS REFERENCE</li> <li>▪ DOUBLE CUTTER FOR EDGE CUT AND LASER KEYS</li> </ul> |  | <ul style="list-style-type: none"> <li>▪ ELETTRONICA E AUTOMATICA</li> <li>▪ DESIGN COMPATTO</li> <li>▪ INTERFACCIA INTERATTIVA</li> <li>▪ DATABASE ILLIMITATO CON COMPARATIVO A BORDO</li> <li>▪ DOPPIA FRESA PER CHIAVI PIATTE E LASER</li> </ul> |  |
|--|---|---|---|

## Door keys



## Car keys



Ford and Jaguar  
Ford e Jaguar



## TECHNICAL FEATURES

Power Supply	90-130V 50-60Hz / 220-240V 50-60Hz
Electronic Equipment	Mainboard with ARM Cortex A8 CPU, 256 MB RAM, NAND 1 GB memory, high resolution axes control
External Connections	2 USB 2.0 ports; 2 RS232 serial ports; 1 LAN port
Key Reading/Decoding System	Electric contact
Lighting	LED - lighted cutting bay
Movements/Axes	2 stepper motor-operated axes

### EDGE CUT KEY SIDE

### LASER KEY SIDE

Clamps	4 faces (supplementary clamps are available for specific markets)	Clamp AC (clamps A, B, C, D, H, V are available)
Gauge	Automatic gauge unlock through the movement of the axes	
Motor	Asynchronous, 0.18 kW	DC electronic motor
Cutter	In Widia $\varnothing$ 63 mm	In Widia $\varnothing$ 2.5 mm
Cutter Speed	1500-3000 rpm (variable speed according to the programmes)	6000 rpm
Absorption	250W (35W in stand-by)	
Dimensions	Width: 340 mm / Depth: 415 mm / Height: 300 mm	
Weight	20 Kg	

## CONSOLE TECHNICAL FEATURES

Power Supply	DC 24V (fed by the key cutting machine)
User Interface	7" industrial colour touch screen, 16:10, resolution 800x480 px, VGA

## CARATTERISTICHE TECNICHE

Alimentazione	90-130V 50-60Hz / 220-240V 50-60Hz
Dotazione Elettronica	Mainboard con CPU ARM Cortex A8, 256 MB RAM, memoria NAND 1 GB, controllo assi ad alta risoluzione
Connessioni Esterne	2 porte USB; 2 porte seriali RS232; 1 LAN
Sistema di Lettura/Decodifica Chiave	Contatto elettrico
Illuminazione	Area di lavoro illuminata a LED
Movimenti/Assi	2 assi pilotati da motori passo passo

### LATO CHIAVI PIATTE

### LATO CHIAVI LASER

Morsetti	4 facce (sono disponibili ulteriori morsetti per mercati specifici)	Morsetto AC (sono disponibili i morsetti A, B, C, D, H, V)
Calibro	Sblocco calibro automatico tramite movimento assi	
Motore	Asincrono 0,18 kW	Elettronico DC
Fresa	In Widia $\varnothing$ 63 mm	In Widia $\varnothing$ 2,5 mm
Velocità Fresa	1500-3000 rpm (velocità variabile a seconda dei programmi)	6000 rpm
Assorbimento	250W (35W in stand-by)	
Dimensioni	Larghezza: 340 mm / Profondità: 415 mm / Altezza: 300 mm	
Peso	20 Kg	

## CARATTERISTICHE TECNICHE CONSOLE

Alimentazione	DC 24V (alimentata dalla duplicatrice)
Interfaccia Utente	Schermo touch screen industriale a colori, 7", 16:10, risoluzione 800x480 px, VGA

\*More versions for specific markets are available.  
 \*Disponibili ulteriori versioni per i mercati specifici.



# 994 LASER

For edge cut and laser automotive keys / Per chiavi piatte e laser automotive



▪ ERGONOMIC DESIGN

▪ PRECISION MECHANICS

▪ INTERACTIVE INTERFACE

▪ STABILIZED CUTTING SPEED

▪ UNLIMITED DATABASE WITH ON BOARD CROSS REFERENCE

▪ 8 CLAMPS FOR ALL AUTOMOTIVE KEYS



▪ DESIGN ERGONOMICO

▪ MECCANICA DI PRECISIONE

▪ INTERFACCIA INTERATTIVA

▪ VELOCITÀ DI TAGLIO STABILIZZATA

▪ DATABASE ILLIMITATO CON COMPARATIVO A BORDO

▪ 8 MORSETTI PER TUTTE LE CHIAVI AUTOMOTIVE



Car keys



Ford and Jaguar  
Ford e Jaguar



## TECHNICAL FEATURES

Power Supply	90-130V 50-60Hz / 220-240V 50-60Hz
Electronic Equipment	Mainboard with CPU ARM Cortex A8, 256 MB RAM, NAND memory on 1 GB, high resolution axes control
External Connections	2 USB 2.0 ports; 2 RS232 serial ports; 1 LAN port
Key Reading/Decoding System	Electric contact
Movements/Axes	2 axes, guided by stepper motors through linear moves, interpolated through high precision ball screws
Clamps	8 clamps are available: A, B, C, D for laser keys; G for edge cut automotive keys (patented); H for Tibbe keys (6 spaces); S for Simplex keys; V for Volkswagen laser keys
Motor	Brushless
Cutter	Widia $\varnothing$ 2.5 mm for laser and Tibbe keys / $\varnothing$ 1.5 mm for edge cut keys
Cutter Speed	6000 rpm
Absorption	125W (50W in stand-by)
Dimensions	Width: 300 mm / Depth: 360 mm / Height: 350 mm
Weight	Machine body 16.5 Kg / Console 0.8 Kg

## CONSOLE TECHNICAL FEATURES

Power Supply	DC 24V (fed by the key cutting machine)
User Interface	7" industrial color touch screen, 16:10, resolution 800x480 px, incorporated CPU

## CARATTERISTICHE TECNICHE

Alimentazione	90-130V 50-60Hz / 220-240V 50-60Hz
Dotazione Elettronica	Mainboard con CPU ARM Cortex A8, 256 MB RAM, memoria NAND 1 GB, controllo assi ad alta risoluzione
Connessioni Esterne	2 porte USB; 2 porte seriali RS232; 1 LAN
Sistema di Lettura/Decodifica Chiave	Contatto elettrico
Movimenti/Assi	2 assi pilotati da motori passo passo su movimenti lineari interpolati tramite viti a ricircolo di sfere di alta precisione
Morsetti	Disponibili 8 morsetti: A, B, C, D per chiavi laser; G per chiavi piatte automotive (brevettato); H per chiavi Tibbe (6 spazi); S per chiavi Simplex; V per chiavi laser Volkswagen
Motore	Brushless
Fresa	Widia $\varnothing$ 2,5 mm per chiavi laser e Tibbe / $\varnothing$ 1,5 mm per chiavi piatte
Velocità Fresa	6000 rpm
Assorbimento	125W (50W in stand-by)
Dimensioni	Larghezza: 300 mm / Profondità: 360 mm / Altezza: 350 mm
Peso	Corpo macchina 16,5 Kg / Console 0,8 Kg

## CARATTERISTICHE TECNICHE CONSOLE

Alimentazione	DC 24V (alimentata dalla duplicatrice)
Interfaccia utente	Schermo touch screen industriale a colori, 7", 16:10, risoluzione 800x480 px, CPU incorporato

# NINJA VORTEX

For laser and dimple keys / Per chiavi laser e punzate



- COMPACT DESIGN
- INTERACTIVE INTERFACE
- UNLIMITED DATABASE WITH ON BOARD CROSS REFERENCE
- HIGH DECODE AND CUT SPEED
- GRAPHIC ENGRAVING ON KEY HEADS
- DESIGN COMPATTO
- INTERFACCIA INTERATTIVA
- DATABASE ILLIMITATO CON COMPARATIVO A BORDO
- ALTA VELOCITÀ DI DECODIFICA E TAGLIO
- INCISIONE GRAFICA SULLE TESTE

---

## Door keys



---

## Car keys







## TECHNICAL FEATURES

Power Supply	90-130V 50-60Hz / 220-240V 50-60Hz
Electronic Equipment	Mainboard with ARM Cortex A8 CPU, 256 MB RAM, NAND 1 GB memory, high resolution axes control
External Connections	2 USB 2.0 ports; 2 RS232 serial ports; 1 LAN port
Key Reading/Decoding System	Electric contact
Lighting	LED - lighted cutting bay
Movements/Axes	3 stepper motor-operated axes
Clamps	Standard equipment includes 4 basic clamps: A01, A02, A03 for laser-type car keys; C01 for dimple keys; other models available upon request
Motor	DC electronic motor
Cutter	Equipment with the following Widia cutters: 1 pc. blade $\varnothing$ 4 mm, 90° cutting edge 0.4 mm (for dimple keys); 1 pc. blade $\varnothing$ 4 mm, cutting edge $\varnothing$ 2.5 mm (for car keys); other models available upon request
Cutter Speed	10000 rpm
Absorption	250W (35W in stand-by)
Dimensions	Width: 340 mm / Depth: 415 mm / Height: 300 mm
Weight	19 Kg

## CONSOLE TECHNICAL FEATURES

Power Supply	DC 24V (fed by the key cutting machine)
User Interface	7" industrial colour touch screen, 16:10, resolution 800x480 px, VGA

## CARATTERISTICHE TECNICHE

Alimentazione	90-130V 50-60Hz / 220-240V 50-60Hz
Dotazione Elettronica	Mainboard con CPU ARM Cortex A8, 256 MB RAM, memoria NAND 1 GB, controllo assi ad alta risoluzione
Conessioni Esterne	2 porte USB; 2 porte seriali RS232; 1 LAN
Sistema di Lettura/Decodifica Chiave	Contatto elettrico
Illuminazione	Area di lavoro illuminata a LED
Movimenti/Assi	3 assi pilotati da motori passo passo
Morsetti	Dotazione di 4 morsetti base: A01, A02, A03 per chiavi auto tipo laser; C01 per chiavi punzonate; altri modelli a richiesta
Motore	Elettronico DC
Fresa	Dotazione delle seguenti frese in Widia: 1 pz gambo $\varnothing$ 4 mm, taglienti a 90° base 0,4 mm (per chiavi punzonate); 1 pz gambo $\varnothing$ 4 mm, taglienti $\varnothing$ 2,5 mm (per chiavi auto); altri modelli a richiesta
Velocità Fresa	10000 rpm
Assorbimento	250W (35W in stand-by)
Dimensioni	Larghezza: 340 mm / Profondità: 415 mm / Altezza: 300 mm
Peso	19 Kg

## CARATTERISTICHE TECNICHE CONSOLE

Alimentazione	DC 24V (alimentata dalla duplicatrice)
Interfaccia Utente	Schermo touch screen industriale a colori, 7", 16:10, risoluzione 800x480 px, VGA

# VERSA

For laser and dimple keys / Per chiavi laser e punzate



- HERMETIC CUTTING BAY
- INTERACTIVE INTERFACE
- MULTIPLE CUTTING SPEEDS
- UNLIMITED DATABASE WITH CODES AND TECHNICAL PARAMETERS
- STANDARD CLAMP COVERING THE 70% OF INSERTED SYSTEMS
- GRAPHIC ENGRAVING ON KEY HEADS
  
- AREA DI LAVORO ERMETICA
- INTERFACCIA INTERATTIVA
- VELOCITÀ DI TAGLIO MULTIPLE
- DATABASE ILLIMITATO CON CODICI E PARAMETRI TECNICI DI DUPLICAZIONE
- MORSETTO STANDARD CON COPERTURA DEL 70% DEI SISTEMI INSERITI
- INCISIONE GRAFICA SULLE TESTE

Door keys



Car keys





## TECHNICAL FEATURES

Power Supply	90-130V 50-60Hz / 220-240V 50-60Hz
User Interface	7" industrial color touch screen, 16:10, resolution 800x480 px, VGA
Electronic Equipment	Mainboard with 600 MHz CPU GEODE, 512 MB RAM, static memory on 4 GB compact flash, high resolution axes control
External Connections	2 USB ports, 1 LAN /Ethernet port; 1 RS232 serial port (9 pin); 1 VGA socket (for touch screen / std video display)
Key Reading/Decoding System	Electric contact
Movements/Axes	3 axes, guided by stepper motors through linear moves, interpolated through high precision ball screws
Clamps	Standard equipment includes 4 basic clamps: A01, A02, A03 for laser-type car keys; C01 master for dimple keys and bow etching; supplementary models available upon request
Motor	Brushless
Cutter	Equipment with the following Widia cutters: 1 pc. blade $\varnothing$ 4 mm, cutting edge $\varnothing$ 2.5 mm (for car keys); 1 pc. blade $\varnothing$ 4 mm, 90° cutting edge 0.4 mm (for cylinder keys); other models available upon request
Cutter Speed	28000 rpm
Absorption	230W
Dimensions	Width: 500 mm / Depth: 430 mm / Height: 375 mm
Color Available	Red / Silver
Weight	37 Kg

## CARATTERISTICHE TECNICHE

Alimentazione	90-130V 50-60Hz / 220-240V 50-60Hz
Interfaccia Utente	Schermo touchscreen industriale a colori, 7", 16:10, risoluzione 800x480 px, VGA
Dotazione Elettronica	Mainboard con CPU GEODE a 600 MHz, 512 MB RAM, memoria statica su compact flash 4 GB, controllo assi ad alta risoluzione
Connessioni Esterne	2 Porte USB; 1 Porta Seriale RS232 (9 pin); 1 Porta LAN / Ethernet; 1 Presa VGA (per display - touch screen / std video)
Sistema di Lettura/Decodifica Chiave	Contatto elettrico
Movimenti/Assi	3 assi pilotati da motori passo passo su movimenti lineari interpolati tramite viti a ricircolo di sfere di alta precisione
Morsetti	Dotazione di 4 morsetti base: A01, A02, A03 per chiavi auto tipo laser; C01 master per chiavi punzonate ed incisione testa; altri modelli a richiesta
Motore	Brushless
Fresa	Dotazione delle seguenti frese in Widia: 1 pz gambo $\varnothing$ 4 mm, taglienti $\varnothing$ 2,5 mm (per chiavi auto); 1 pz gambo $\varnothing$ 4 mm, taglienti a 90° base 0,4 mm (per chiavi cilindro); altri modelli a richiesta
Velocità Fresa	28000 rpm
Assorbimento	230W
Dimensioni	Larghezza: 500 mm / Profondità: 430 mm / Altezza: 375 mm
Colori disponibili	Rosso / Argento
Peso	37 Kg



# SIGMA PRO

For bit and pump keys / Per chiavi a mappa e a pompa



- OPTICAL READING
  - HYPERFAST DUPLICATION
  - INTERACTIVE INTERFACE
  - READING AREA SEPARATED FROM THE CUTTING BAY
  - CARD MAKER
  - EASY-TO-UPDATE AND ADVANCED SOFTWARE TOOLS
- 
- LETTURA OTTICA
  - DUPLICAZIONE ULTRARAPIDA
  - INTERFACCIA INTERATTIVA
  - VANO DI LETTURA SEPARATO DAL TAGLIO
  - CARD MAKER
  - STRUMENTI SOFTWARE AVANZATI FACILMENTE AGGIORNABILI

Door keys



Car keys



Ford and Jaguar  
Ford e Jaguar

## TECHNICAL FEATURES

Power Supply	AC 100-240 V, 50-60 Hz
User Interface	7" industrial color touch screen, 16:10, resolution 800x480 px, VGA
Electronic Equipment	Mainboard with 600 MHz CPU GEODE, 512 MB RAM, static memory on 4 GB compact flash, high resolution axes control
External Connections	1 USB 2.0 port; 1 RS485 serial port; 1 Ethernet port; 1 VGA port
Key Reading/Decoding System	Static reading from digital image (Optical + CCD)
Lighting	LED-lighted cutting bay
Movements/Axes	3 axes guided by stepper motors
Clamps	Equipment in relation to specific markets
Motor	Brushless
Cutter	In Widia $\varnothing$ 100x1.25 mm
Cutter Speed	900-1800 rpm (variable speed according to the programmes)
Absorption	500W (70W in stand-by)
Dimensions	Width: 500 mm / Depth: 440 mm / Height: 450 mm (600 mm when the housing is open)
Weight	45 Kg

## CARATTERISTICHE TECNICHE

Alimentazione	AC 100-240 V, 50-60 Hz
Interfaccia Utente	Schermo touchscreen industriale a colori, 7", 16:10, risoluzione 800x480 px, VGA
Dotazione Elettronica	Mainboard con CPU GEODE a 600 MHz, 512 MB RAM, memoria statica su compact flash 4 GB, controllo assi ad alta risoluzione
Connessioni Esterne	1 Porta USB 2.0; 1 Porta seriale RS485; 1 Porta Ethernet; 1 Porta VGA
Sistema di Lettura/Decodifica Chiave	Lettura statica da immagine digitale (Ottica + CCD)
Illuminazione	Area di lavoro illuminata a LED
Movimenti/Assi	3 assi pilotati da motori passo passo
Morsetti	Dotazione in relazione ai mercati specifici
Motore	Brushless
Fresa	In Widia $\varnothing$ 100x1,25 mm
Velocità Fresa	900-1800 rpm (velocità variabile a seconda dei programmi)
Assorbimento	500W (70W in stand-by)
Dimensioni	Larghezza: 500 mm / Profondità: 440 mm / Altezza: 450 mm (600 mm a carter aperto)
Peso	45 Kg

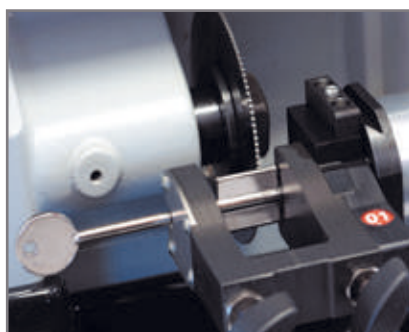

# CARAT

For edge cut and cruciform keys / Per chiavi piatte e a croce



- CARRIAGE AND GAUGE UNLOCK BUTTON
- EASY SELECTION OF CLAMP SIDE
- CLAMPS LOCKING WITH ERGONOMIC HANDLE
- LAMP CONTROLLED BY AN INDEPENDENT SWITCH
- PULSANTE SGANCIO CARRELLO E SGANCIO CALIBRO
- FACILE SELEZIONE DEL LATO MORSETTO
- CHIUSURA MORSETTI CON MANOPOLA ERGONOMICA
- LAMPADA CONTROLLATA DA INTERRUOTTORE INDIPENDENTE

---

## Door keys



---

## Car keys



with adaptor  
con adattatore





## TECHNICAL FEATURES

VERSION	Carat Duo	Carat Quattro	Carat Quattro W
Power Supply	230V 50Hz / 110V 60Hz / 100V 50-60Hz		
Lighting	Neon		
Movements/Axes	2 axes		
Clamps	2/4 faces; more versions for specific markets are available		
Tracer	Hardened with regulation nuts		
Motor	Asynchronous, single speed, 0.25 kW		
Cutter	HSS ø 80 mm		In Widia ø 80 mm
Cutter Speed	640 rpm		1400 rpm
Brush	Tynex		
Dimensions	Width: 400 mm / Depth: 460 mm / Height: 270 mm (without lamp); 440 mm (with lamp)		
Weight	25 Kg		

## CARATTERISTICHE TECNICHE

VERSIONE	Carat Duo	Carat Quattro	Carat Quattro W
Alimentazione	230V 50Hz / 110V 60Hz / 100V 50-60Hz		
Illuminazione	Neon		
Movimenti/Assi	2 assi		
Morsetti	2/4 facce; sono disponibili ulteriori versioni per mercati specifici		
Tastatore	Temprato con ghiera di regolazione		
Motore	Asincrono, singola velocità, 0,25 kW		
Fresa	HSS ø 80 mm		Widia ø 80 mm
Velocità Fresa	640 rpm		1400 rpm
Spazzola	Tynex		
Dimensioni	Larghezza: 400 mm / Profondità: 460 mm / Altezza: 270 mm (senza lampada); 440 mm (con lampada)		
Peso	25 Kg		

\*More versions for specific markets are available.

\*Disponibili ulteriori versioni per i mercati specifici.

# NINJA DARK

For edge cut and cruciform keys / Per chiavi piatte e a croce



- **AUTOMATIC**
  - **COMPACT DESIGN**
  - **QUICK COPY IN A SINGLE STEP**
  - **MICROMETRIC SYSTEM OF CALIBRATION**
  - **OPTIONAL CONSOLE FOR ADVANCED FUNCTIONS**
- 
- **AUTOMATICA**
  - **DESIGN COMPATTO**
  - **COPIA VELOCE IN UN SOLO PASSAGGIO**
  - **SISTEMA MICROMETRICO DI TARATURA**
  - **CONSOLE INTEGRABILE PER FUNZIONI AVANZATE**

---

## Door keys



---

## Car keys



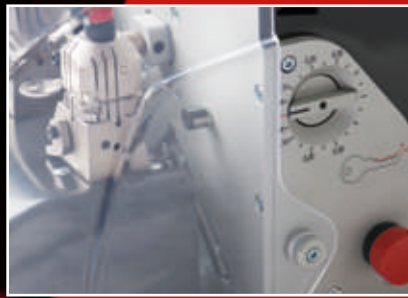

## TECHNICAL FEATURES

Power Supply	90-130V 50-60Hz / 220-240V 50-60Hz
Electronic Equipment	High resolution axes control
External Connections	1 RS232 serial port
Lighting	LED - lighted cutting bay
Movements/Axes	2 stepper motor-operated axes
Clamps	4 faces; more clamps are available for specific markets
Gauge	Automatic gauge unlock through the movement of the axes
Tracer	Hardened
Motor	Asynchronous; 0.18 kW
Cutter	In Widia $\varnothing$ 63 mm
Cutter Speed	2000 rpm
Absorption	250W (15W in stand-by)
Dimensions	Width: 340 mm / Depth: 415 mm / Height: 300 mm
Weight	20 Kg

## CARATTERISTICHE TECNICHE

Alimentazione	90-130V 50-60Hz / 220-240V 50-60Hz
Dotazione Elettronica	Controllo assi ad alta risoluzione
Connessioni Esterne	1 porta seriale RS232
Illuminazione	Area di lavoro illuminata a LED
Movimenti/Assi	2 assi pilotati da motori passo passo
Morsetti	4 facce; sono disponibili ulteriori morsetti per mercati specifici
Calibro	Sblocco calibro automatico tramite movimento assi
Tastatore	Temprato
Motore	Asincrono 0,18 kW
Fresa	In Widia $\varnothing$ 63 mm
Velocità Fresa	2000 rpm
Assorbimento	250W (15W in stand-by)
Dimensioni	Larghezza: 340 mm / Profondità: 415 mm / Altezza: 300 mm
Peso	20 Kg

\*More versions for specific markets are available.

\*Disponibili ulteriori versioni per i mercati specifici.



# EASY

For edge cut and cruciform keys / Per chiavi piatte e a croce



- REVERSIBLE CLAMPS
- INDEPENDENT SWITCH FOR THE BRUSH
- CARRIAGE SAFETY MICROSWITCH
- MORSETTI REVERSIBILI
- INTERRUOTTORE INDIPENDENTE DELLA SPAZZOLA
- MICROINTERRUPTORE DI SICUREZZA SUL CARRELLO

Door keys



Car keys



## TECHNICAL FEATURES

VERSION	Easy	Easy Quattro
Power Supply	230V 50Hz / 110V 60Hz	
Movements/Axes	2 axes	
Clamps	2 faces	4 faces
Tracer	Hardened	
Motor	Asynchronous one speed	
Cutter	HSS 80x5x16 mm	
Cutter Speed	700 rpm	
Brush	Tynex	
Absorption	200W	
Dimensions	Width: 370 mm / Depth: 370 mm / Height: 240 mm	
Weight	19 Kg	

## CARATTERISTICHE TECNICHE

VERSIONE	Easy	Easy Quattro
Alimentazione	230V 50Hz / 110V 60Hz	
Movimenti/Assi	2 assi	
Morsetti	2 facce	4 facce
Tastatore	Temprato	
Motore	Asincrono a una velocità	
Fresa	HSS 80x5x16 mm	
Velocità Fresa	700 rpm	
Spazzola	Tynex	
Assorbimento	200W	
Dimensioni	Larghezza: 370 mm / Profondità: 370 mm / Altezza: 240 mm	
Peso	19 Kg	

# T-REX | T-REX ADVANCE

For laser, dimple and tubular keys / Per chiavi laser, punzonate e tubolari



- INNOVATIVE FIXED CLAMPS WITH 3 CLAMPING SYSTEMS
- INTUITIVE LED PANEL THAT FACILITATES OPERATIONS ON THE MACHINE
- NON-GLARE WORKING PLATFORM LIGHTING, TO WORK SAFELY
- STRONG AND ERGONOMIC STRUCTURE, FLUID MOVEMENTS
- PATENTED TECHNOLOGY FOR THE MOTORIZED TOOL POSITIONING SYSTEM\*



- INNOVATIVI MORSETTI CON 3 SISTEMI DI TENUTA CHIAVI
- PANNELLO A LED INTUITIVO CHE FACILITA LE OPERAZIONI A BORDO MACCHINA
- ILLUMINAZIONE PIANO LAVORO SENZA EFFETTO ABBAGLIAMENTO PER OPERARE IN SICUREZZA
- STRUTTURA ROBUSTA ED ERGONOMICA, MOVIMENTAZIONE FLUIDA
- TECNOLOGIA BREVETTATA PER SISTEMA DI CAMBIO UTENSILI MOTORIZZATO\*



Door keys



Car keys



with adaptor  
con adattatore



\* Only for the T-Rex Advance version  
\* Solo per la versione T-Rex Advance





## TECHNICAL FEATURES

MODEL	T-Rex	T-Rex Advance
Power Supply	230V 50Hz / 110V 60Hz / 100V 50-60Hz	
Lighting	Led	
Movements/Axes	3 axes with sliding guides	
Clamps	Fixed with interchangeable tools	Tilting with interchangeable tools
Motor	Asynchronous; with 0.18 kW speed	Asynchronous; with 0.18 kW variable speed
Cutter	HSS $\varnothing$ 6 mm	HSS $\varnothing$ 6 mm (optionals in Widia)
Cutter Speed	6000 rpm	From 6000 rpm to 12000 rpm
Tools Positioning	Manual	Motorized
Absorption	200W	300W
Dimensions	Width: 320 mm / Depth: 420 mm (with chip tray 475 mm) / Height: 490 mm	
Weight	24 Kg	25 Kg

## CARATTERISTICHE TECNICHE

MODELLO	T-Rex	T-Rex Advance
Alimentazione	230V 50Hz / 110V 60Hz / 100V 50-60Hz	
Illuminazione	Led	
Movimenti/Assi	Su 3 assi con guide a sfere	
Morsetti	Fisso con piastrine intercambiabili	Basculante con piastrine intercambiabili
Motore	Motore asincrono ad una velocità 0,18 kW	Motore asincrono a velocità regolabile 0,18 kW
Fresa	HSS $\varnothing$ 6 mm	HSS $\varnothing$ 6 mm (opzionali in Widia)
Velocità Fresa	6000 rpm	Da 6000 rpm a 12000 rpm
Cambio Utensili	Manuale	Motorizzato
Assorbimento	200W	300W
Dimensioni	Larghezza: 320 mm / Profondità: 420 mm (con cassetto raccogli trucioli 475 mm) / Altezza: 490 mm	
Peso	24 Kg	25 Kg

\*More versions for specific markets are available.  
 \*Disponibili ulteriori versioni per i mercati specifici.



# PUNTO

For laser and dimple keys / Per chiavi laser e punzionate



- MILLING CUTTERS AND TRACERS HOLDER
- WIDE AND MOVABLE PROTECTION SHIELD
- VERTICAL SUSPENSIONS
  
- PORTA FRESE E TASTATORI
- PROTEZIONE AMPIA E MOBILE
- MOLLEGGIO VERTICALE

---

## Door keys



---

## Car keys



with adaptor  
con adattatore

with adaptor  
con adattatore

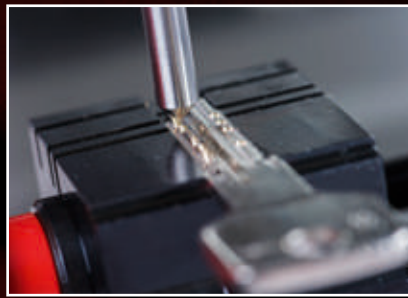
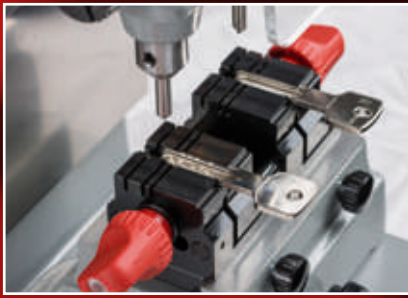

## TECHNICAL FEATURES

Power Supply	230V 50Hz / 110V 60Hz
Lighting	Incandescent light bulb 25W
Movements/Axes	3 axes
Clamps	Fixed
Tracer	Hardened
Motor	Asynchronous, single speed
Cutter	HSS $\varnothing$ 6 mm
Cutter Speed	9000 rpm
Absorption	200W
Dimensions	Width: 220 mm / Depth: 380 mm / Height: 380 mm
Weight	21 Kg

## ACCESSORIES

MA	Adaptors for VAG keys
MK45	Adaptors for Kaba 45° keys
MK15	Adaptors for Kaba 15° keys
MK5	Adaptors for Keso 5° keys
MM	Adaptors for Mercedes car keys
MTB	Adaptors for Tibbe keys
MOMAX	Adaptors for Opel and Ford C-Max keys

## CARATTERISTICHE TECNICHE

Alimentazione	230V 50Hz / 110V 60Hz
Illuminazione	Lampada a incandescenza 25W
Movimenti/Assi	3 assi
Morsetti	Fissi
Tastatore	Temprato
Motore	Asincrono, singola velocità
Fresa	HSS $\varnothing$ 6 mm
Velocità Fresa	9000 rpm
Assorbimento	200W
Dimensioni	Larghezza: 220 mm / Profondità: 380 mm / Altezza: 380 mm
Peso	21 Kg

## ACCESSORI

MA	Adattatori per chiavi VAG
MK45	Adattatori per chiavi Kaba 45°
MK15	Adattatori per chiavi Kaba 15°
MK5	Adattatori per chiavi Keso 5°
MM	Adattatori per chiavi Mercedes
MTB	Adattatori per chiavi Tibbe
MOMAX	Adattatori per chiavi Opel e Ford C-Max

# ARCADIA

For tubular keys / Per chiavi tubolari



- WIDE AND MOVABLE PROTECTION SHIELD
- CLAMPS BAY
- COMPATIBLE WITH CLAMPS AVAILABLE ON THE MARKETS
- PROTEZIONE AMPIA E MOBILE
- VANO PORTA MORSETTI
- COMPATIBILE CON MORSETTI PRESENTI NEL MERCATO

---

Door keys

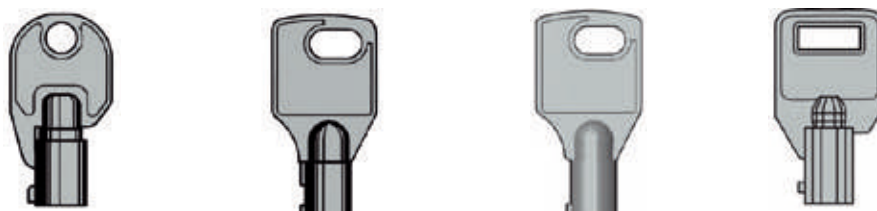



## TECHNICAL FEATURES

Power Supply	110V 50Hz / 230V 50Hz
Lighting	LED - lighted cutting bay
Movements/Axes	2 axes
Clamps	More clamps for specific markets are available on demand
Tracer	Hardened
Motor	Asynchronous; 0.15 kW
Cutter	HSS $\varnothing$ 5.95 mm
Cutter Speed	2800 rpm
Absorption	200W
Dimensions	Width: 210 mm / Depth: 400 mm / Height: 210 mm
Weight	12.5 Kg

## ACCESSORIES

KT0	For Chicago, Meroni, P.C. Cortellezzi keys
KT2	For Progres, Fontaine and Corni keys
KT3	For Progres, Fontaine and Corni keys
KT4	For Vigie Picard keys
KT5	For Laperche keys
KT6	For JPM keys
KT7	For FTH and DAD-Decayeux keys
KT8	For Pollux keys
KT9	For Pollux keys
KT13	For Cavith keys



## CARATTERISTICHE TECNICHE

Alimentazione	110V 50Hz / 230V 50Hz
Illuminazione	Area di lavoro illuminata a LED
Movimenti/Assi	2 assi
Morsetti	Morsetti per mercati specifici disponibili su richiesta
Tastatore	Temprato
Motore	Asincrono; 0,15 kW
Fresa	HSS $\varnothing$ 5,95 mm
Velocità Fresa	2800 rpm
Assorbimento	200W
Dimensioni	Larghezza: 210 mm / Profondità: 400 mm / Altezza: 210 mm
Peso	12,5 Kg

## ACCESSORI

KT0	Per chiavi Chicago, Meroni, P.C. Cortellezzi
KT2	Per chiavi Progres, Fontaine e Corni
KT3	Per chiavi Progres, Fontaine e Corni
KT4	Per chiavi Vigie Picard
KT5	Per chiavi Laperche
KT6	Per chiavi JPM
KT7	Per chiavi FTH e DAD-Decayeux
KT8	Per chiavi Pollux
KT9	Per chiavi Pollux
KT13	Per chiavi Cavith

# FALCON

For special keys / Per chiavi speciali



- CLAMP WITH "EASY FIT" LOCKING
- CLAMP WITH 360° ROTATION
- STURDY AND HANDY
- MORSETTO CON CHIUSURA "EASY FIT"
- MORSETTO CON ROTAZIONE A 360°
- STABILE E MANEGGEVOLE

Door keys



Car keys



Ford and Jaguar  
Ford e Jaguar



## TECHNICAL FEATURES

Power Supply	110V 50Hz / 230V 50Hz
Movements/Axes	2 axes
Clamps	Clamps for specific markets are available on demand
Tracer	Cut by code
Motor	Asynchronous, single speed
Cutter	HSS ø 80 mm
Cutter Speed	1500 rpm
Brush	Tynex
Absorption	200W
Dimensions	Width: 400 mm / Depth: 370 mm / Height: 230 mm
Weight	17 Kg

## ACCESSORIES

01	Clamp for Ford and Jaguar car keys
02	Clamp for Abus keys
03	Clamp for Abloy keys

## CARATTERISTICHE TECNICHE

Alimentazione	110V 50Hz / 230V 50Hz
Movimenti/Assi	2 assi
Morsetti	Morsetti per mercati specifici disponibili su richiesta
Tastatore	Taglio a codice
Motore	Asincrono, singola velocità
Fresa	HSS ø 80 mm
Velocità Fresa	1500 rpm
Spazzola	Tynex
Assorbimento	200W
Dimensioni	Larghezza: 400 mm / Profondità: 370 mm / Altezza: 230 mm
Peso	17 Kg

## ACCESSORI

01	Morsetto per chiavi auto Ford e Jaguar
02	Morsetto per chiavi Abus
03	Morsetto per chiavi Abloy

# 202 | 203

For bit keys and pump keys / Per chiavi a mappa e a pompa

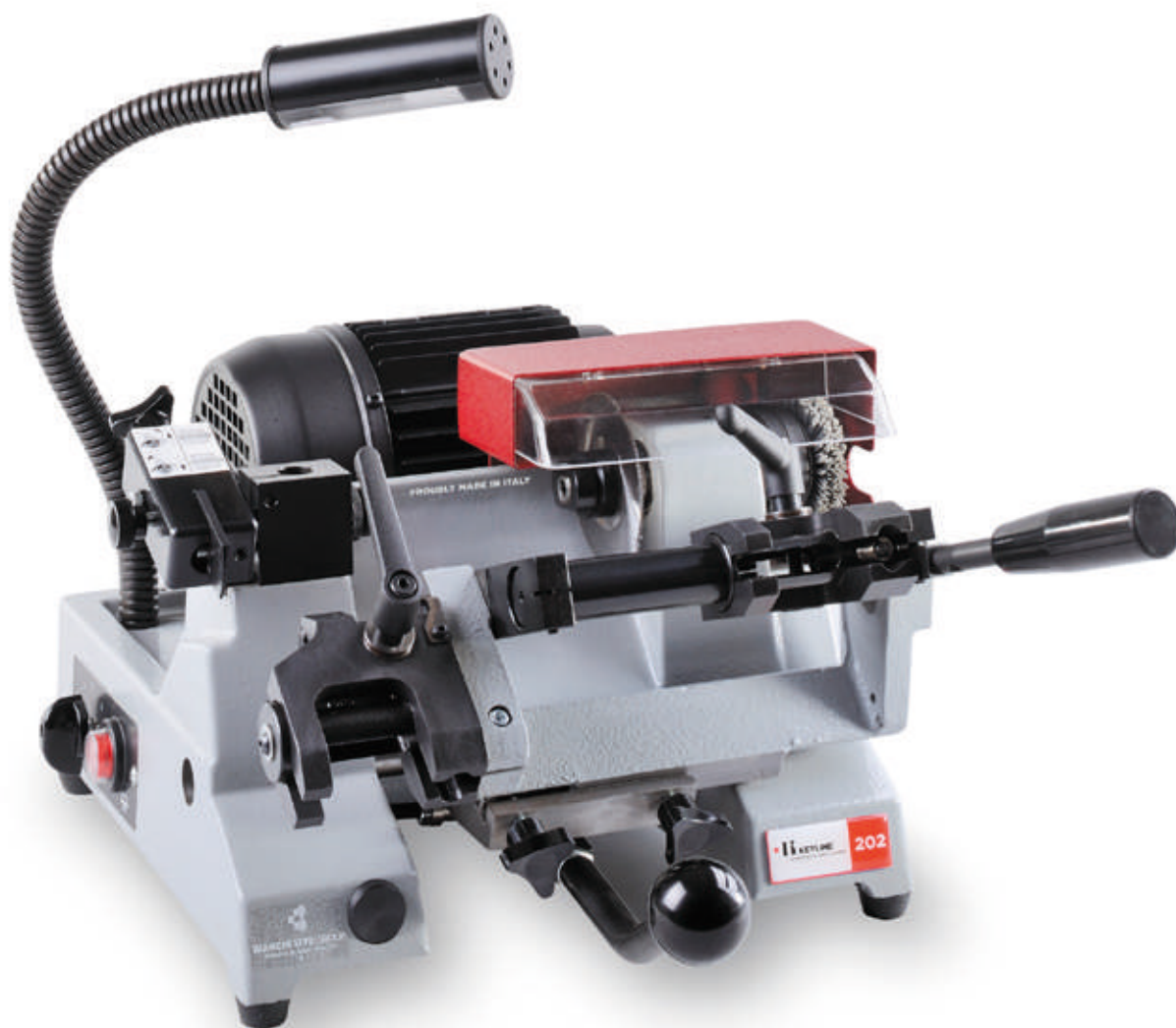

- SELF-CENTERING GRIPS (202)
- GANASCE AUTOCENTRANTI (202)
- CENTERING DEVICES (203)
- CENTRATORI (203)
- STURDY AND SILENT
- SOLIDA E SILENZIOSA

Door keys



only with 203  
solo con 203



## TECHNICAL FEATURES

MODEL	202	203
Version	Without centering devices	With centering devices
Power Supply	230V 50Hz	
Lighting	Incandescent light bulb 15W	
Movements/Axes	3 axes	
Clamps	Self-centring, made of tempered steel (more clamps are available on request)	Self-centring, made of tempered steel with countertops for female keys
Tracer	Hardened	
Motor	Asynchronous, two speed	
Cutter	HSS $\varnothing$ 80x1.5 mm (more models are available on request)	HSS $\varnothing$ 80x1.5 mm
Cutter Speed	350/700 rpm	
Brush	Tynex	
Absorption	400W	
Dimensions	Width: 380 mm / Depth: 450 mm / Height: 270 mm	
Weight	32 Kg	

## CARATTERISTICHE TECNICHE

MODELLO	202	203
Versione	Senza centratori	Con centratori
Alimentazione	230V 50Hz	
Illuminazione	Lampada a incandescenza 15W	
Movimenti/Assi	3 assi	
Morsetti	Autocentranti in acciaio temprato (altri morsetti disponibili su richiesta)	Autocentranti in acciaio temprato con contropunte per chiavi femmina
Tastatore	Temprato	
Motore	Asincrono a due velocità	
Fresa	HSS $\varnothing$ 80x1,5 mm (altri modelli disponibili su richiesta)	HSS $\varnothing$ 80x1,5 mm
Velocità Fresa	350/700 rpm	
Spazzola	Tynex	
Assorbimento	400W	
Dimensioni	Larghezza: 380 mm / Profondità: 450 mm / Altezza: 270 mm	
Peso	32 Kg	



**203**

Version with centering device  
Versione con centratori



# 204

For bit keys and pump keys / Per chiavi a mappa e a pompa



▪ SELF-CENTERING GRIPS

▪ MOVEMENT OF THE CARRIAGE  
ON ROLL GUIDES

▪ STURDY AND SILENT

▪ GANASCE AUTOCENTRANTI

▪ MOVIMENTO DEL CARRELLO  
SU GUIDE A RULLI

▪ SOLIDA E SILENZIOSA

Door keys



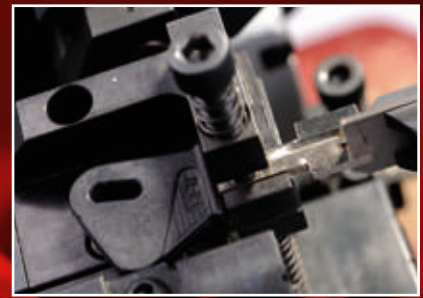

## TECHNICAL FEATURES

Power Supply	230V 50Hz
Lighting	Incandescent light bulb 15W
Movements/Axes	On a cross-shaped table, thanks to roller guides
Clamps	For standard/double-bit male and female keys with self-centring tempered steel grips; for pump keys with round and square stem; for vertical cuts
Tracer	Hardened
Motor	Asynchronous, two speed
Cutter	HSS $\phi$ 80x1.5 mm
Cutter Speed	350/700 rpm
Absorption	400W
Dimensions	Width: 330 mm / Depth: 530 mm / Height: 390 mm
Weight	44 Kg

## CARATTERISTICHE TECNICHE

Alimentazione	230V 50Hz
Illuminazione	Lampada a incandescenza 15W
Movimenti/Assi	Su tavola a croce tramite guide a rulli
Morsetti	Per chiavi mappa, doppia mappa maschio e femmina con ganasce autocentranti in acciaio temprato; per chiavi pompa con gambo sezione rotonda e quadra; per tagli verticali
Tastatore	Temprato
Motore	Asincrono a due velocità
Fresa	HSS $\phi$ 80x1,5 mm
Velocità Fresa	350/700 rpm
Assorbimento	400W
Dimensioni	Larghezza: 330 mm / Profondità: 530 mm / Altezza: 390 mm
Peso	44 Kg



# 206

For bit keys and pump keys / Per chiavi a mappa e a pompa



- **HANDY AND PRECISE**
- **MOVEMENT OF THE CARRIAGE ON ROLL GUIDES**
- **STURDY AND SILENT**
- **MANEGGEVOLE E PRECISA**
- **MOVIMENTO DEL CARRELLO SU GUIDE A RULLI**
- **SOLIDA E SILENZIOSA**

---

Door keys



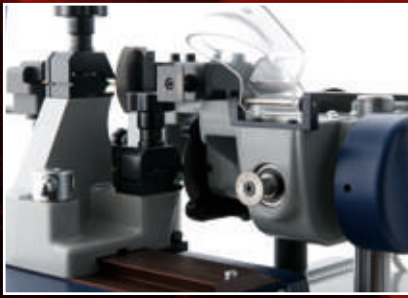

## TECHNICAL FEATURES

Power Supply	230V 50Hz
Movements/Axes	On a cross-shaped table, thanks to roller guides
Clamps	Reversible for round stem and mailbox keys
Tracer	Hardened
Motor	Asynchronous, single speed
Cutter	First cutter: $\varnothing$ 80x1.3 mm Second cutter: $\varnothing$ 25x1.25 mm
Cutter Speed	First cutter: 500 rpm Second cutter: 1500 rpm
Absorption	400W
Dimensions	Width: 330 mm / Depth: 530 mm / Height: 390 mm
Weight	44 Kg

## CARATTERISTICHE TECNICHE

Alimentazione	230V 50Hz
Movimenti/Assi	Su tavola a croce tramite guide a rulli
Morsetti	Reversibili per chiavi con gambo sezione rotonda e chiavi per casellari postali
Tastatore	Temprato
Motore	Asincrono singola velocità
Fresa	Prima fresa: $\varnothing$ 80x1,3mm Seconda fresa: $\varnothing$ 25x1,25mm
Velocità Fresa	Prima fresa: 500 rpm Seconda fresa: 1500 rpm
Assorbimento	400W
Dimensioni	Larghezza: 330 mm / Profondità: 530 mm / Altezza: 390 mm
Peso	44 Kg

# 884 DECRYPTOR MINI

For electronic keys, remote controls and keyless systems /  
Per chiavi elettroniche, telecomandi e sistemi keyless



- MAXIMUM CALCULATION POWER
- LIMITLESS CONNECTIVITY
- MINIMUM FOOTPRINT
- AFFORDABLE PRICE



- MASSIMA POTENZA DI CALCOLO
- CONNETTIVITÀ SENZA LIMITI
- MINIMO INGOMBRO
- PREZZO EASY

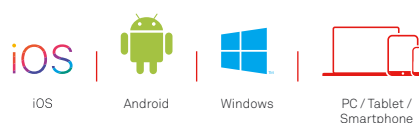

Car key cloning made easy, with extreme calculation power and an unparalleled low price.

**884 Decryptor Mini** is simple to use: just connect it to your Android smartphone or tablet with USB-OTG capability or to a PC Windows (7 and subsequent versions) with an Internet connection, download the **Keyline Cloning Tool mobile App\*** from Google Play Store or the PC Software from the website [www.keyline.it](http://www.keyline.it) or [www.keyline-usa.com](http://www.keyline-usa.com) and start the transponder-equipped car key automatic cloning procedure, without having to press any buttons and also without connecting to a power outlet.

Its extremely high calculation power, maximum flexibility and ease of use make it the ideal choice for professionals in the key business.

884 Decryptor Mini can be equipped with Bluetooth & Power Adaptor, the next-generation rechargeable battery with Bluetooth technology to use 884 Decryptor Mini wirelessly. With Bluetooth & Power Adaptor, 884 Decryptor Mini can be managed from any Windows PC, smartphone and tablet, Android and iOS\*\*, thus offering an unlimited cloning service.

La clonazione di chiavi auto con una maneggevolezza unica per una potenza di calcolo estrema e un prezzo senza paragoni.

**884 Decryptor Mini** è semplice da usare: basta collegarla al proprio smartphone o tablet dotato di sistema operativo Android provvisto di funzionalità USB-OTG oppure al PC Windows (7 e successivi) connesso a Internet, scaricare la **App Keyline Cloning Tool\*** da Google Play Store o il Software per PC dal sito [www.keyline.it](http://www.keyline.it) o [www.keyline-usa.com](http://www.keyline-usa.com), e avviare la procedura di clonazione in automatico di chiavi auto con transponder, senza premere nemmeno un pulsante e senza collegarsi alla presa elettrica. La sua estrema potenza di calcolo, la massima versatilità e semplicità d'uso la rendono la scelta ideale a portata di tutti i professionisti del key business.

884 Decryptor Mini può essere dotata di Bluetooth & Power Adaptor, la batteria ricaricabile di ultima generazione con tecnologia Bluetooth per utilizzare il dispositivo in modalità wireless, senza l'ausilio dei cavi di connessione. Con Bluetooth & Power Adaptor, 884 Decryptor Mini può essere gestita da qualsiasi PC Windows, smartphone e tablet, sia Android che iOS\*\*, offrendo così un servizio di clonazione illimitato.

884 Decryptor Mini requires always internet connection.

\* Keyline Cloning Tool mobile App must be used only with 884 Decryptor Mini.

\*\* The iOS version is available exclusively with the use of Bluetooth & Power Adaptor.

884 Decryptor Mini richiede sempre la connessione internet.

\* La App Keyline Cloning Tool è da utilizzarsi esclusivamente con 884 Decryptor Mini.

\*\* La versione per iOS è disponibile esclusivamente con l'utilizzo della batteria Keyline Bluetooth & Power Adaptor.





### Transponder cloning:

- Texas® fixed code
- Texas® Crypto
- Texas® 80-bit (for Kia®, Hyundai®, Ford® and Toyota®)
- Philips® fixed code
- First generation Philips® Crypto\*
- Second generation Philips® Crypto
- Megamos® fixed code
- Megamos® Crypto\*\* (to be activated with TKM. Xtreme Kit)
- Megamos® Crypto (for Kia®, Chevrolet® - Daewoo®, Pontiac®)
- Keyline Keyless Kit
- Keyline RFD100

### Clonazione transponder:

- Texas® codice fisso
- Texas® Crypto
- Texas® 80-bit (per Kia®, Hyundai®, Ford® e Toyota®)
- Philips® codice fisso
- Philips® Crypto di prima generazione\*
- Philips® Crypto di seconda generazione
- Megamos® codice fisso
- Megamos® Crypto\*\* (da attivare con TKM. Xtreme Kit)
- Megamos® Crypto (per Kia®, Chevrolet® - Daewoo®, Pontiac®)
- Keyline Keyless Kit
- Keyline RFD100

### TECHNICAL FEATURES

Power Supply	5V
External Connections	USB
Absorption	500mA
Connectivity	USB
Dimensions	Width: 120 mm / Depth: 100 mm / Height: 90 mm
Weight	200 gr

### CARATTERISTICHE TECNICHE

Alimentazione	5V
Connessioni Esterne	USB
Assorbimento	500mA
Connettività	USB
Dimensioni	Larghezza: 120 mm / Profondità: 100 mm / Altezza: 90 mm
Peso	200 gr

All the brands and trade marks mentioned here are the exclusive property of the respective car manufacturers or groups.  
 \* Regarding first generation Philips® Crypto transponder, 884 Decryptor Mini can clone some PH1A; but not PH1D and also Keyline RK50 remote controls.  
 \*\* In order to clone TKM-supported Megamos® Crypto transponders, the 884 Decryptor Mini must be activated through the TKM. Xtreme Kit. For a complete list of models that can be cloned to date, please consult the TKM. Xtreme Kit page. To get information on prices, please contact your area sales agent or the nearest distributor.

Tutti i marchi e i marchi di fabbrica qui pubblicati sono marchi registrati e di esclusiva proprietà delle rispettive case o gruppi automobilistici.  
 \* Circa i transponder Philips® Crypto di prima generazione 884 Decryptor Mini è in grado di clonare alcuni transponder PH1A; non sono clonabili transponder PH1D e i radiocomandi Keyline RK50.  
 \*\* Per effettuare la clonazione dei transponder Megamos® Crypto supportati da TKM, 884 Decryptor Mini deve essere attivata tramite TKM. Xtreme Kit. Per consultare la lista completa di modelli ad ora clonabili si veda la pagina di TKM. Xtreme Kit. Per essere informati sui prezzi, si prega di rivolgersi direttamente al proprio agente di zona o al distributore più vicino.

# BLUETOOTH & POWER ADAPTOR

For 884 Decryptor Mini / Per 884 Decryptor Mini



- STABLE AND LONG-LASTING CHARGE
- WIRELESS CLONING SERVICE
- IMMEDIATELY USABLE WITH THE KEYLINE CLONING TOOL APP FOR IOS AND ANDROID
- CHARGING VIA PC CONNECTION OR THROUGH BATTERY CHARGER
- CARICA STABILE E DI LUNGA DURATA
- SERVIZIO DI CLONAZIONE WIRELESS
- UTILIZZO IMMEDIATO CON LA APP KEYLINE CLONING TOOL PER IOS E ANDROID
- RICARICA TRAMITE CONNESSIONE A PC O TRAMITE CARICA BATTERIA DA RETE

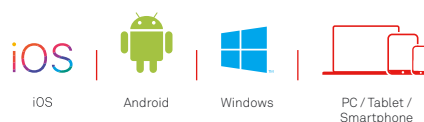

Keyline **Bluetooth & Power Adaptor** is the next-generation rechargeable battery with Bluetooth technology to use 884 Decryptor Mini wirelessly, without the aid of connecting cables. With Bluetooth & Power Adaptor, 884 Decryptor Mini can be managed from any smartphone and tablet\*, Android and iOS.

\* 884 Decryptor Mini with Bluetooth & Power Adaptor can also be used with PC (Windows).

**Bluetooth & Power Adaptor** di Keyline è la batteria ricaricabile di ultima generazione con tecnologia Bluetooth per utilizzare 884 Decryptor Mini in modalità wireless, senza l'ausilio dei cavi di connessione.

Con Bluetooth & Power Adaptor, 884 Decryptor Mini può essere gestita da qualsiasi PC Windows, smartphone e tablet\*, sia Android che iOS.

\* 884 Decryptor Mini con Bluetooth & Power Adaptor può essere utilizzata anche con PC (Windows).



# 884 DECRYPTOR ULTEGRA

For electronic keys, remote controls and keyless systems /  
Per chiavi elettroniche, telecomandi e sistemi keyless



- INTUITIVE MULTI-LANGUAGE GRAPHIC DISPLAY
- DISPLAY GRAFICO INTUITIVO E MULTILINGUA
- VIRTUALLY UNLIMITED POSSIBILITIES OF EXPANSION
- POSSIBILITÀ DI ESPANSIONE VIRTUALMENTE ILLIMITATE
- EXTREMELY FAST DUPLICATION
- ESTREMA VELOCITÀ DI DUPLICAZIONE

The **884 Decryptor Ultegra** device is Keyline's solution for the cloning of electronic keys and remote controls.

Its advanced computing power, ease of use and versatility guaranteed by easy and quick updates, make this the ideal choice for specialists in the automotive technology sector.

Il dispositivo **884 Decryptor Ultegra** è la soluzione Keyline per la clonazione delle chiavi elettroniche e telecomandi.

La sua estrema potenza di calcolo, unita alla grande semplicità d'uso e alla versatilità garantita da una facile e veloce procedura di aggiornamento, la rendono la scelta ideale per lo specialista nel campo dell'automotive technology.

\* All the brands and trade marks mentioned here are the exclusive property of the respective car manufacturers or groups.  
\*\* In order to clone Texas® 80-bit transponders, the 884 Decryptor Ultegra requires internet connection.  
\*\*\* In order to clone TKM-supported Megamos® Crypto transponders the 884 Decryptor Ultegra requires internet connection and must be activated through the TKM. Xtreme Kit.

\* Tutti i marchi e i marchi di fabbrica qui pubblicati sono marchi registrati e di esclusiva proprietà delle rispettive case o gruppi automobilistici.  
\*\* Per effettuare la clonazione dei transponder Texas® 80 bit, 884 Decryptor Ultegra deve essere connessa a internet.  
\*\*\* Per effettuare la clonazione dei transponder Megamos® Crypto supportati da TKM, 884 Decryptor Ultegra deve essere attivata tramite TKM. Xtreme Kit e connessa a internet.





### Transponder cloning\*

- Stand-alone cloning for Philips® Crypto 1<sup>st</sup> Generation transponders.
- Cloning in stand alone mode for fixed code transponders.
- Stand-alone cloning for Texas® Crypto transponders using Keyline TK100 electronic heads, GK100 glass chips or CK100 carbon chips.
- Cloning of a part of the Texas® 80-bit\*\* transponders using TK100 electronic heads or CKG carbon chips.
- Stand-alone cloning for Philips® Crypto 1<sup>st</sup> Generation transponders ID45 VAG-Ford, ID 4W Peugeot, ID42 Volkswagen and Seat.
- Stand-alone cloning for Philips® Crypto 2<sup>nd</sup> Generation transponder using TK100, GK100 or CK100.
- Cloning for Megamos® Crypto\*\*\* transponders using TKM electronic heads or GKM glass chips.
- Programming of fixed code transponder through the manual entry of ID.
- Automatic generation of some codes for fixed code transponder.
- Stand-alone cloning for Megamos® Crypto transponders for Kya, Chevrolet-Daewoo and Pontiac.

### Remote control cloning

- Built-in radio frequency station for cloning Philips® Crypto 2<sup>nd</sup> generation remote control through the RK60, the new Keyline electronic head equipped with remote control. The RK60 is fully compatible with all Keyline horseshoe blades that are used with Philips® Crypto 2<sup>nd</sup> generation equipped vehicles.
- RFD100 and RFD80 models for Ford remote keys. Clonable with the 884 Decryptor Ultegra (RFD100) or entirely on-board programmable (RFD80), they guarantee perfect synchronization with the original Ford remote without altering the functionality.

### Other functions

- Multi-functional alphanumeric keypad.
- RS232 & USB connection.
- Graphical display.
- Self antenna for all transponder types.
- 12V cigarette lighter adaptor for use directly in the vehicle.

### TECHNICAL FEATURES

<b>Power Supply</b>	DC 12V; power adapter included
<b>External Connections</b>	RS232 and USB serial ports
<b>Absorption</b>	20W
<b>Dimensions</b>	Width: 220 mm / Depth: 130 mm / Height: 70 mm
<b>Weight</b>	1 Kg

### Clonazione transponder\*

- Clonazione di transponder Philips® Crypto di prima generazione.
- Clonazione di tutti i tipi di transponder a codice fisso.
- Clonazione di transponder Texas® Crypto tramite il TK100, il GK100 o il CK100.
- Clonazione di parte dei transponder Texas® 80-bit\*\* tramite TK100 o CKG.
- Clonazione di transponder Philips® Crypto di prima generazione ID45 VAG-Ford, ID 4W Peugeot, ID42 Volkswagen e Seat.
- Clonazione di transponder Philips® Crypto di seconda generazione tramite il TK100, il GK100 o il CK100.
- Clonazione di transponder Megamos® Crypto\*\*\* tramite il TKM o il GKM.
- Programmazione transponder a codice fisso tramite inserimento manuale ID.
- Generazione automatica di alcuni codici per transponder a codice fisso.
- Clonazione di transponder Megamos® Crypto per Kya, Chevrolet-Daewoo e Pontiac.

### Clonazione telecomandi

- Stazione radio incorporata per clonazioni di telecomandi dei veicoli equipaggiati con transponder Philips® Crypto di II generazione tramite RK60, la nuova testa elettronica Keyline dotata di telecomando. RK60 è compatibile con tutti gli Horseshoe Keyline impiegati nei veicoli equipaggiati con transponder Philips® Crypto di II generazione.
- Modelli RFD100 e RFD80 per telecomandi Ford. Clonabili con 884 Decryptor Ultegra (RFD100) o programmabile a bordo veicolo (RFD80), garantiscono la sincronizzazione perfetta con il telecomando Ford originale, senza alterarne il funzionamento.

### Altre funzioni

- Tastiera alfanumerica multifunzione.
- Connessioni RS232 e USB.
- Display grafico multilingua.
- Stessa antenna per tutti i tipi di transponder.
- Adattatore per alimentazione nel veicolo tramite presa accendisigari.

### CARATTERISTICHE TECNICHE

<b>Alimentazione</b>	DC 12V; alimentatore universale incluso
<b>Connessioni Esterne</b>	Porta USB e seriale RS232
<b>Assorbimento</b>	20W
<b>Dimensioni</b>	Larghezza: 220 mm / Profondità: 130 mm / Altezza: 70 mm
<b>Peso</b>	1 Kg

# KEYLINE KEYLESS SYSTEMS

Thanks to its proven technology for Megamos® Crypto (ID48) transponder cloning and TK100, the universal electronic head, Keyline leads the way towards Keyless Systems.

The coupling of an electronic head and a mechanical key makes it possible to duplicate the BMW, Volvo, Volkswagen, Toyota, Kia, Hyundai, Nissan, Infiniti, Jeep, Ram, Chrysler and Dodge systems easily and accurately. Keyline's research and development innovation is at the roots of these products that enhance the Keyline range in the field of automotive technology.



## BMW Kit

Code: **BM100KIT**



MODEL	FROM	TO
SERIES 1	2007	2010
SERIES 3	2005	2011
SERIES 5	2004	2010
SERIES 6	2004	2010
X1	2009	2011
X5	2007	2011



## Volvo Kit

Code: **VL100KIT**



MODEL	FROM	TO
V70	2008	2011
XC70	2008	2011
S80	2008	2011

Keyline, grazie alla consolidata tecnologia Keyline per la clonazione dei transponder Megamos® Crypto, e del TK100, la testa elettronica universale, apre la nuova frontiera dei sistemi Keyless.

L'accoppiata di testa elettronica e chiave meccanica permette di duplicare i sistemi BMW, Volvo, Volkswagen, Toyota, Kia, Hyundai, Nissan, Infiniti, Jeep, Ram, Chrysler e Dodge con facilità e precisione. L'innovazione nella ricerca e nello sviluppo di Keyline è alla base di questi prodotti, che arricchiscono la gamma di Keyline nell'ambito dell'automotive technology.



## Toyota Prius Kit

Code: **TR100KIT**



MODEL	FROM	TO
PRIUS	2004	2009

## Toyota Yaris Kit

Code: **TRY100KIT**



MODEL	FROM	TO
YARIS*	2010	2012

\*Available only for certain fittings.  
\*Disponibile solo per alcuni allestimenti.



All brands and trademarks published here are exclusive property of the relevant car makers or groups. Tutti i marchi e i marchi di fabbrica qui pubblicati sono di esclusiva proprietà delle rispettive case o gruppi automobilistici.

# KEYLINE KEYLESS SYSTEMS

## Universal Kit Code: UNIVERSAL100KIT



The new Universal Kit has crossed the threshold of automotive duplication. Actually, the kit has been devised for universal use, as for instance, entrance control systems in the home environment, so that the end user can enjoy a remarkable degree of utilization flexibility. This new kit can be utilized in any type of application featuring a transponder that can be cloned with Keyline's 884 Decryptor Mini and 884 Decryptor Ultegra machines. The kit comes in a practical format featuring the TK100UN device and a handy key-ring.

Con il nuovo Universal Kit sono stati superati i confini della duplicazione automotive. Questo kit infatti è stato ideato per usi generici, permettendo così all'utente finale una versatilità di utilizzo notevole. In qualsiasi tipo di applicazione in cui è presente un transponder clonabile con 884 Decryptor Mini o con 884 Decryptor Ultegra potete utilizzare questo nuovo kit. Lo potete ricevere in un pratico formato che include il dispositivo TK100UN e un comodo anello portachiavi.



## New Volvo Kit Code: VLMKIT\*



MODEL	FROM	TO
C30	2008	Today
S40	2008	Today
S80	1999	Today
V40	2012	Today
V50	2004	Today

\*For this Kit, the Keyline cloning device must be activated through the TKM. Xtreme Kit.  
\*Per questo Kit, è necessario attivare i dispositivi di clonazione Keyline con TKM. Xtreme Kit.



## Kia and Hyundai Kit Code: KIHY100KIT



MAKE	MODEL	FROM	TO
Kia	SORENTO	2010	2012
	SPORTAGE	2010	2012
	CEED*	2011	Today
	SOUL*	2011	Today
Hyundai	SANTA FE	2011	2012
	SONATA	2011	Today

\*Available only for certain fittings.  
\*Disponibile solo per alcuni allestimenti.





**Chrysler, Dodge, Jeep, Ram Kit** Code: **Y100KIT**



MAKE	MODEL	FROM	TO
Chrysler	300, 300C	2008	2010
	TOWN & COUNTRY	2008	2013



Dodge	CHALLENGER	2008	2012
	CHARGER	2008	2010
	DART	2013	2013
	DURANGO	2011	2012
	GRAND CARAVAN	2008	2013



Jeep	COMMANDER	2013	2013
	GRAND CHEROKEE	2006	2007
	GRAND CHEROKEE	2008	2010



Ram	1500	2011	2012
	2500, 3500 HEAVY DUTY	2006	2010
	3500, 4500, 5500 CHASSIS CAB	2011	2011



**Nissan Kit** Code: **NS100KIT**



MAKE	MODEL	FROM	TO
Infiniti	EX35	2008	2012
	FX35	2009	2012
	FX50	2009	2012
	G25	2011	2012
	G37 2DR	2008	2011
	G37 4DR	2009	2012
	JX35	2013	2013
	M35	2006	2007
	M35	2006	2007
	M35	2008	2010
	M37	2011	2012
	M45	2006	2010



Nissan	370Z	2009	2013
	ALTIMA 2DR	2007	2013
	ALTIMA 4DR	2007	2012
	ALTIMA 4DR	2013	2013
	CUBE	2009	2011
	JUKE	2011	2013
	LEAF	2011	2013
	MAXIMA	2009	2013
	MURANO	2009	2012
	PATHFINDER	2013	2013
	QUEST	2013	2013
	SENTRA	2013	2013



**Volkswagen Kit** Code: **VWMKIT\***



MODEL	FROM	TO
PASSAT	2006	2013

\*For this Kit, the Keyline cloning device must be activated through the TKM. Xtreme Kit.  
\*Per questo Kit, è necessario attivare i dispositivi di clonazione Keyline con TKM. Xtreme Kit.

# KEYLINE TV

The channel dedicated to locksmiths on the Keyline website /  
Sul sito Keyline la televisione dedicata ai locksmiths

It's the TV channel dedicated to Keyline's world, with stories from five continents, interviews and news. All the tutorials of the key cutting machines and the cloning devices are available on a dedicated page.

It's a real online training with lots of videos that show in a clear and precise way all the procedures.

To access Keyline TV you just need to visit the page with the same name on the website or the YouTube channel.

È il canale TV dedicato al mondo Keyline, con servizi dai cinque continenti, interviste e notizie. E sull'apposita pagina, sono disponibili tutti i tutorial delle macchine duplicatrici e dei dispositivi di clonazione.

È una vera e propria formazione online con tantissimi video che mostrano in modo chiaro e preciso tutte le procedure.

Per accedere a Keyline TV basta visitare l'omonima pagina del sito o il canale YouTube.



The video archive of key cutting machines and cloning devices tutorials is online  
Online la videoteca dei tutorial sulle duplicatrici e sui dispositivi di clonazione



<https://www.keyline.it/it/keyline-tv>

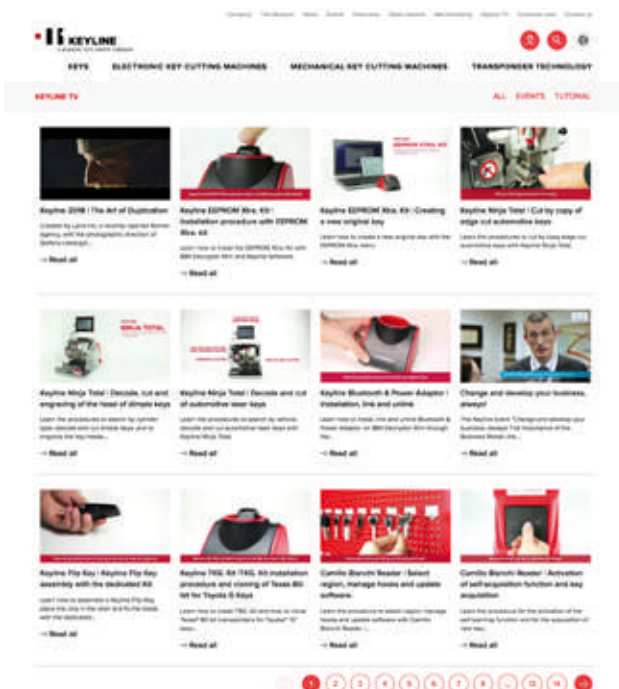

# KEYCENTER



## SINGLE PIECES

KC201	Varnished piece of furniture with 5 drawers
KC101-EU	Hook panel with new led light and EU plug
KC101-USA-JAP	Hook panel with new led light and USA/JAP plug
KC101-AUS	Hook panel with new led light and AUS plug
KC101-UK	Hook panel with new led light and UK plug
KC301	Varnished piece of furniture with a hinged door and a drawer
KC301/S	Varnished piece of furniture with a hinged door and a drawer with lock
KC102	Display window
KC025	Riser for key cutting machines
KC010	Handle with screws
GA070	Single nickel hook 70 mm (box 50 pcs)
GA090	Single nickel hook 90 mm (box 50 pcs)

## PEZZI SINGOLI

KC201	Modulo con 5 cassetti
KC101-EU	Pannello ganci con luci a LED e presa EU
KC101-USA-JAP	Pannello ganci con luci a LED e presa USA-JAP
KC101-AUS	Pannello ganci con luci a LED e presa AUS
KC101-UK	Pannello ganci con luci a LED e presa UK
KC301	Modulo con cassetto e anta
KC301/S	Modulo con cassetto e anta con serratura
KC102	Vetrina
KC025	Piattaforma rialzata per duplicatrici
KC010	Maniglia di ricambio con viti
GA070	Gancio nichelato da 70 mm
GA090	Gancio nichelato da 90 mm

**Keycenter is the ideal furnishing solution for your shop.** Its modular design makes it possible for you to choose your furnishings according to your needs. You can choose between preassembled kits and individual modules: support structures for your key cutting machines, halogen lights to brighten the work area, panels with hooks and cabinets and drawer units to keep your keys and work tools in order.

**Keycenter è la soluzione d'arredo ideale per il vostro punto vendita.** La sua natura modulabile permette di comporre il vostro mobile sulla base delle vostre esigenze. Potete scegliere tra kit preassemblati o singoli moduli: piani d'appoggio per le vostre duplicatrici, faretto alogeni per illuminare la zona di lavoro, pannelli con ganci e mobili ad ante e con cassetti per ordinare le vostre chiavi e i vostri strumenti di lavoro.

Examples of modularity  
Esempi di composizione

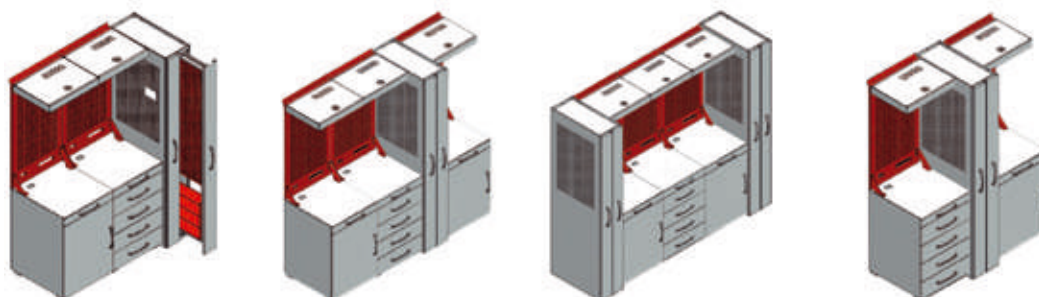

To get information on the dimensions, please consult the Keycenter page on the [www.keyline.it](http://www.keyline.it) website  
Per essere informati sulle dimensioni, si veda la pagina dei Keycenter sul sito [www.keyline.it](http://www.keyline.it)



## MODULAR KITS







KC100	<b>KEYCENTER 1</b> - Stock piece of furniture with 4 shelves in the lower part and drilled walls
KC200-EU	<b>KEYCENTER 2</b> - Modular kit composed of a piece of furniture with 5 drawers and a hook panel with new led light and EU plug (KC101-EU + KC 201)
KC200-USA-JAP	<b>KEYCENTER 2</b> - Modular kit composed of a piece of furniture with 5 drawers and a hook panel with new led light and USA/JAP plug (KC101-USA-JAP + KC 201)
KC200-AUS	<b>KEYCENTER 2</b> - Modular kit composed of a piece of furniture with 5 drawers and a hook panel with new led light and AUS plug (KC101-AUS + KC 201)
KC200-UK	<b>KEYCENTER 2</b> - Modular kit composed of a piece of furniture with 5 drawers and a hook panel with new led light and UK plug (KC101-UK + KC 201)
KC300-EU	<b>KEYCENTER 3</b> - Modular kit composed of a piece of furniture with a drawer, a hinged door and a hook panel with new led light and EU plug (KC101-EU + KC 301)
KC300-USA-JAP	<b>KEYCENTER 3</b> - Modular kit composed of a piece of furniture with a drawer, a hinged door and a hook panel with new led light and USA/JAP plug (KC101-USA-JAP + KC 301)
KC300-AUS	<b>KEYCENTER 3</b> - Varnished preassembled kit composed of a piece of furniture with a drawer, a hinged door, and a hook panel with new led light and AUS plug (KC101-AUS + KC 301)
KC300-UK	<b>KEYCENTER 3</b> - Modular kit composed of a piece of furniture with a drawer, a hinged door and a hook panel with new led light and UK plug (KC101-UK + KC 301)
KC210	Varnished preassembled kit composed of a piece of furniture with 5 drawers and an upper display window (KC102 + KC201)
KC310	Varnished preassembled kit composed of a piece of furniture with drawer, hinged door and upper display window (KC102 + KC301)

## KIT PREASSEMBLATI

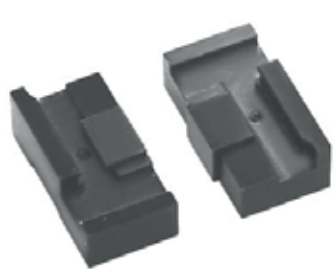
KC100	<b>KEYCENTER 1</b> - Modulo di stoccaggio con 4 mensole nella parte inferiore e pareti esterne forate
KC200-EU	<b>KEYCENTER 2</b> Kit preassemblato in metallo verniciato composto da modulo con 5 cassetti, pannello ganci con luci a LED e presa EU (KC101-EU + KC 201)
KC200-USA-JAP	<b>KEYCENTER 2</b> Kit preassemblato in metallo verniciato composto da modulo con 5 cassetti, pannello ganci con luci a LED e presa USA-JAP (KC101-USA-JAP + KC 201)
KC200-AUS	<b>KEYCENTER 2</b> Kit preassemblato in metallo verniciato composto da modulo con 5 cassetti, pannello ganci con luci a LED e presa AUS (KC101-AUS + KC 201)
KC200-UK	<b>KEYCENTER 2</b> Kit preassemblato in metallo verniciato composto da modulo con 5 cassetti, pannello ganci con luci a LED e presa UK (KC101-UK + KC 201)
KC300-EU	<b>KEYCENTER 3</b> Kit preassemblato in metallo verniciato composto da modulo con cassetto, anta e pannello ganci con luci a LED e presa EU (KC101-EU + KC 301)
KC300-USA-JAP	<b>KEYCENTER 3</b> Kit preassemblato in metallo verniciato composto da modulo con cassetto, anta e pannello ganci con luci a LED e presa USA-JAP (KC101-USA-JAP + KC 301)
KC300-AUS	<b>KEYCENTER 3</b> Kit preassemblato in metallo verniciato composto da modulo con cassetto, anta e pannello ganci con luci a LED e presa AUS (KC101-AUS + KC 301)
KC300-UK	<b>KEYCENTER 3</b> Kit preassemblato in metallo verniciato composto da modulo con cassetto, anta e pannello ganci con luci a LED e presa UK (KC101-UK + KC 301)
KC210	Kit preassemblato composto da modulo con 5 cassetti e vetrina superiore (KC102 + KC201)
KC310	Kit preassemblato composto da modulo con anta e cassetto e vetrina superiore (KC102 + KC301)

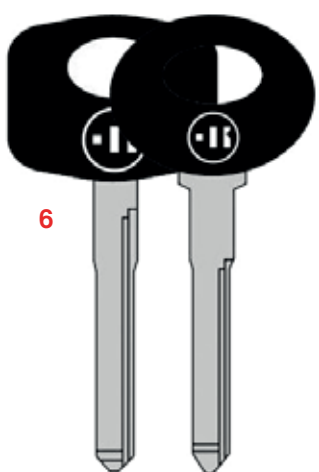
To get information on the dimensions, please consult the Keycenter page on the [www.keyline.it](http://www.keyline.it) website  
Per essere informati sulle dimensioni, si veda la pagina dei Keycenter sul sito [www.keyline.it](http://www.keyline.it)

# TECHNICAL ILLUSTRATIONS AND SYMBOLS | ILLUSTRAZIONI TECNICHE E SEGNI CONVENZIONALI

TO FIT :		1 MERCEDES (D)	
<p><b>OPTIONAL 2</b></p> <p><b>MM 3</b> Morsetti per chiavi Mercedes Jaws for Mercedes keys Spannbacken für Mercedes-Schlüssel Étaux pour clés Mercedes Mordazas para llaves Mercedes</p> 	<p><b>5</b></p> <p><b>T-REX T-REX ADVANCE</b></p>  <p><b>PUNTO</b></p> 	<p><b>6</b></p>  <p><b>7</b></p> <p><b>MB57P MB54P</b></p> <p><b>MB41P</b></p> <p><b>8</b> <b>PATENTED KEYBLANK</b> <b>9</b> <b>PROTECTED SYSTEM</b></p> 	
<p><b>STANDARD 2</b></p> <p><b>4</b></p>  <p><b>2.5 mm</b></p> <p><b>RIC01810B</b> Fresino HC011 Cutter HC011 Fräser HC011 Fraise HC011 Fresa HC011</p>  <p><b>RIC01811B</b> Tastatore C011 Tracer Point C011 Taster C011 Palpeur C011 Palpador C011</p> 			

**1** Marca principale  
Main brand  
Hauptmarke  
Marque principale  
Marca principal

**2** Attrezzatura (di serie/non di serie) per la duplicazione  
Equipment (standard/optional) for the duplication  
Gerät (standard/optionale) für die Kopie  
Équipement (standard/optionnel) pour la duplication  
Equipo (de serie/opcionales) para la duplicación

**3** Codice e descrizione accessorio  
Accessory code and description  
Artikelnr. und Zubehörsbeschreibung  
Code et description de l'accessoire  
Código y descripción del accesorio

**4** Caratteristiche fresa  
Cutter specifications  
Fräuserspezifikation  
Caractéristiques de la fraise  
Datos fresa

**5** Macchine duplicatrici  
Key cutting machines  
Schlüsselkopiermaschinen  
Machines à tailler  
Máquinas duplicadoras

**6** Chiave  
Key  
Schlüssel  
Clé  
Llave

**7** Articolo  
Article  
Artikel  
Article  
Artículo

**8** Chiave grezza brevettata  
Patented keyblank  
patentierter Schlüsselrohling  
Clé brute brevetée  
Llave en bruto patentada

**9** Sistema protetto  
Protected system  
Geschütztes System  
Système protégé  
Sistema protegido

# SYMBOLS | SIMBOLOGIE

**OPTIONAL** Accessorio/accessori non di serie  
Optional accessory/accessories  
Optionale Zubehör/Zubehöre  
Accessoire/accessoires optionaux  
Accesorio/accesorios opcionales

**STANDARD** Accessorio/accessori di serie  
Standard accessory/accessories  
Standard Zubehör/Zubehöre  
Accessoire /accessoires standard  
Accesorio/accesorios de serie



Chiavi cilindro  
Cylinder keys  
Zylinderschlüssel  
Clés pour cylindres  
Llaves cilindro



Chiavi auto e accessori  
Car keys and accessories  
Auto-Schlüssel und Zubehör  
Accessoires et clés pour voitures  
Llaves para auto y accesorios



Chiavi per camion e accessori  
Truck keys and accessories  
LKW-Schlüssel und Zubehör  
Accessoires et clés pour camion  
Llaves para camión y accesorios



Chiavi patent  
Cold forged keys  
Patentschlüssel  
Clés à patent  
Llaves patent



Chiavi a doppia mappa e pompa  
Double bit and pump keys  
Doppelbart-Pumpenschlüssel  
Clés à double panneton et pompe  
Llaves a doble paletón y pompa



Chiavi a croce  
Cruciform keys  
Kreuzbartschlüssel  
Clés cruciformes  
Llaves a cruz



Chiavi per casellari postali  
Mail box keys  
Kastenschlüssel  
Clés pour casiers  
Llaves de buzón



Guida veloce ai sistemi chiavi laser  
Quick guide to laser key systems  
Kurzanleitung für Laser-Schlüssel Systeme  
Guide rapide des systemes de clés laser  
Guía rápida a los sistemas llaves láser



Frese  
Cutters  
Fräser  
Fraises  
Fresas



Fresino a punta  
Angle tip cutter  
Spitzfräser  
Fraise pointu  
Fresa de punto



Fresino gambo cilindrico  
Cylindrical milling cutter  
Bahnenfräser  
Fraise cylindrique  
Fresa cilíndrica



**CHIAVI CILINDRO**

---

**CYLINDER KEYS**

---

**ZYLINDERSCHLÜSSEL**

---

**CLÉS POUR SERRURES À CYLINDRE**

---

**LLAVES PARA CERRADURAS A CILINDRO**

---



TO FIT: **ABLOY (S)**



AB1

AB1P



Abloy Profile



**202**



**203**



**POWER LYNX  
SIGMA PRO**

**OPTIONAL**

**CSA**

*Carrello per chiavi Abloy  
Carriage for Abloy keys  
Schlitten für Abloy-Schlüssel  
Chariot pour clés Abloy  
Carro para llaves de Abloy*



**T3P**

*Tastatore 3 posizioni  
3 position tracer  
3 Positions-Taster  
Palpeur 3 positions  
Palpador 3 posiciones*



**T3P/COD**

*Tastatore 3 posizioni a codice  
3 position code cutting tracer  
Verstellbarer 3 Positionen Taster  
Palpeur 3 positions à code  
Palpador de 3 posiciones con código*



**OPTIONAL**

**OPZ05311B**

*Morsetto 09 per chiavi Abloy  
Jaw 09 for Abloy keys  
Spannbacke 09 für Abloy-Schlüssel  
Étau 09 pour clés Abloy  
Mordaza 09 para llaves Abloy*

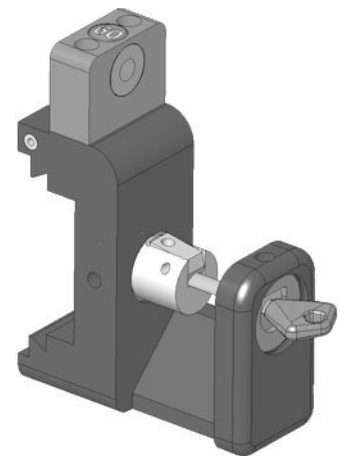

TO FIT: **ABLOY (S)**



AB1P



**FALCON**

**OPTIONAL**

**OPZ08773B**

*Morsetto 03 per chiavi Abloy  
Jaw 03 for Abloy keys  
Spannbacke 03 für Abloy Schlüssel  
Étau 03 pour clés Abloy  
Mordaza 03 para llaves Abloy*



TO  
FIT :

ABLOY (S)

**OPZ08120B**  
Morsetto C17  
Jaw C17  
Spannbacke C17  
Étau C17  
Mordaza C17  
**OPTIONAL**



**VERSA**



AB1P

  
2.50 mm  
**RIC05048B**  
Fresino V003  
Cutter V003  
Fräser V003  
Fraise V003  
Fresa V003  
**STANDARD**

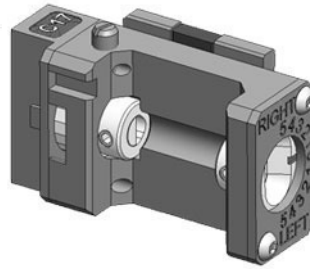

TO  
FIT :

ABLOY (S)

**OPTIONAL**

**OPZ09416B**  
Morsetto 04 per chiavi Abloy  
Jaw 04 for Abloy keys  
Spannbacke 04 für Abloy-Schlüssel  
Étau 04 pour clés Abloy  
Mordaza 04 para llaves Abloy

**RIC01868B**  
Fresa HSSG10  
Cutter HSSG10  
Fräser HSSG10  
Fraise HSSG10  
Fresa HSSG10

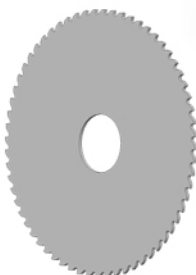

**FALCON**

**EXEC**





TO  
FIT: **ABLOY (S)**

**Protec  
Protec 2**

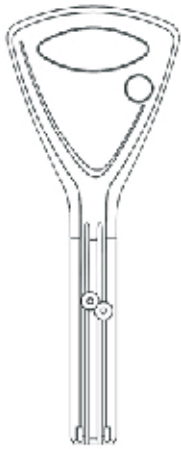

**SIGMA PRO**

**OPTIONAL**

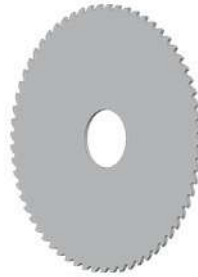

**RIC06716B**  
*Fresa WSPL  
Cutter WSPL  
Fräser WSPL  
Fraise WSPL  
Fresa WSPL*

**OPZ10432B**  
*Morsetto 17  
Jaw 17  
Spannbacke 17  
Étau 17  
Mordaza 17*

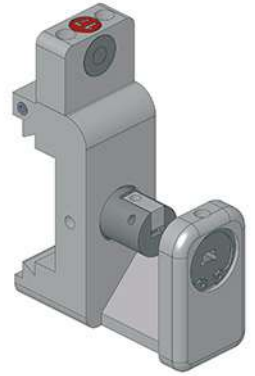

TO  
FIT: **ABLOY (S)**

**Novel**

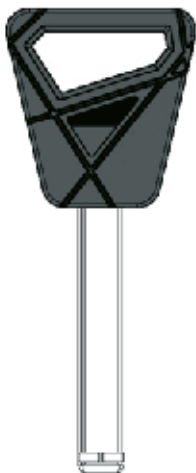

**SIGMA PRO**

**OPTIONAL**

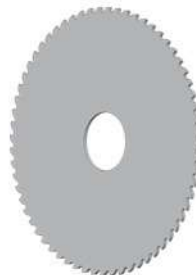

**RIC06716B**  
*Fresa WSPL  
Cutter WSPL  
Fräser WSPL  
Fraise WSPL  
Fresa WSPL*

**OPZ10433B**  
*Morsetto 18  
Jaw 18  
Spannbacke 18  
Étau 18  
Mordaza 18*

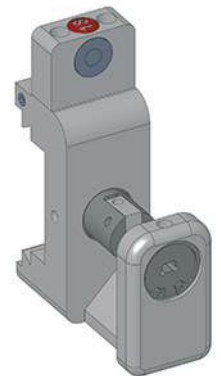

**OPTIONAL**

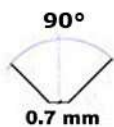

**RIC01791B**  
Fresino HB001  
Cutter HB001  
Fräser HB001  
Fraise HB001  
Fresa HB001



**RIC01792B**  
Tastatore B001  
Tracer Point B001  
Taster B001  
Palpeur B001  
Palpador B001

**STANDARD**



**RIC01793B**  
Fresino HB020  
Cutter HB020  
Fräser HB020  
Fraise HB020  
Fresa HB020



**RIC01794B**  
Tastatore B020  
Tracer Point B020  
Taster B020  
Palpeur B020  
Palpador B020



**303/304/305**



**T-REX  
T-REX ADVANCE**



**PUNTO**

Extra Classe



CA48

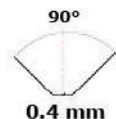

**RIC05044B**  
Fresino V001  
Cutter V001  
Fräser V001  
Fraise V001  
Fresa V001  
**STANDARD**



OR

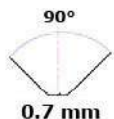

**RIC05618B**  
Fresino V013  
Cutter V013  
Fräser V013  
Fraise V013  
Fresa V013  
**OPTIONAL**

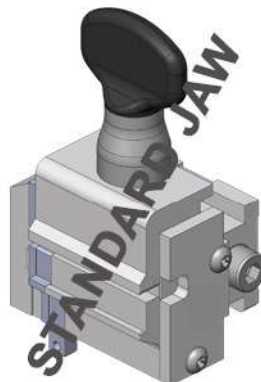

**NINJA TOTAL**



**NINJA VORTEX**



**VERSA**

TO FIT: **ABUS (D)**

TS/TSX

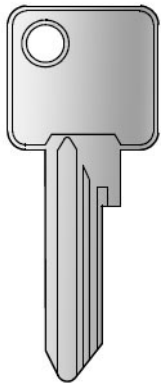

→ CISA



**DEZMO**

**OPTIONAL**

**OPZ08624B**  
 Morsetto Z21 per chiavi SP-TSP  
 Jaw Z21 for SP-TSP keys  
 Spannbacke Z21 für SP-TSP Schlüssel  
 Étau Z21 pour clés SP-TSP  
 Mordaza Z21 para llaves SP-TSP



TO FIT: **ABUS (D)**

DX6-DX8

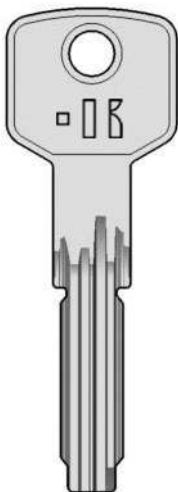

→ **CA70**

→ CISA



**303/304/305**



**T-REX  
T-REX ADVANCE**



**PUNTO**

**OPTIONAL**

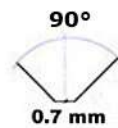

**RIC01791B**  
 Fresino HB001  
 Cutter HB001  
 Fräser HB001  
 Fraise HB001  
 Fresa HB001



**RIC01792B**  
 Tastatore B001  
 Tracer Point B001  
 Taster B001  
 Palpeur B001  
 Palpador B001

**STANDARD**

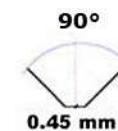

**RIC01793B**  
 Fresino HB020  
 Cutter HB020  
 Fräser HB020  
 Fraise HB020  
 Fresa HB020



**RIC01794B**  
 Tastatore B020  
 Tracer Point B020  
 Taster B020  
 Palpeur B020  
 Palpador B020



TO  
FIT :

ABUS (D)

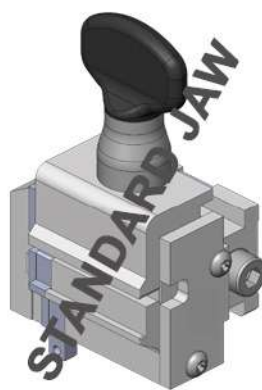
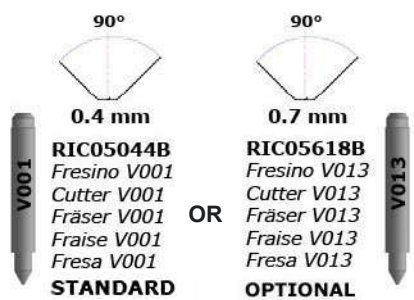

**NINJA TOTAL**



**NINJA VORTEX**



**VERSA**

DX6-DX8

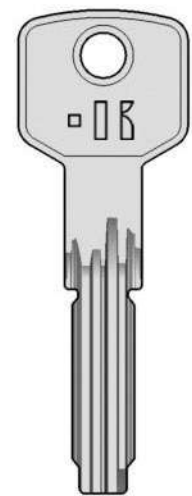

CA70



→ CISA

TO  
FIT :

ABUS (D)

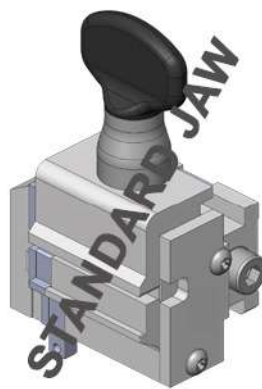
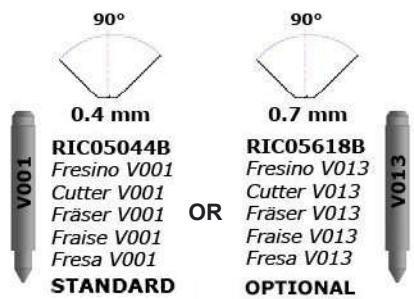

**NINJA TOTAL**



**NINJA VORTEX**



**VERSA**

XP2

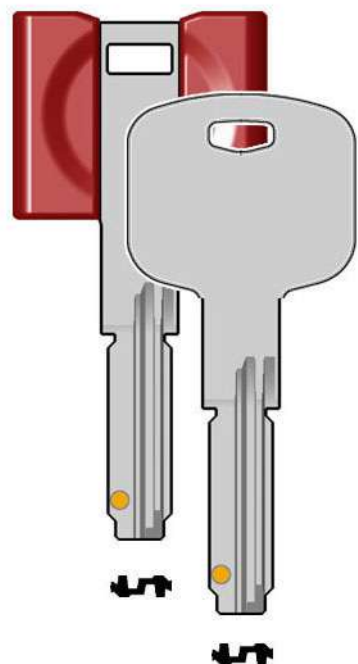

→ CISA



PROTECTED SYSTEM

TO  
FIT: **ABUS (D)**

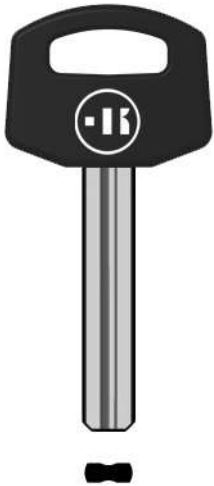

ABU12P

PLUS



**POWER LYNX  
SIGMA PRO**

**OPTIONAL**

**OPZ05313B**

*Morsetto 08 per chiavi Abus Plus  
Jaw 08 for Abus Plus keys  
Spannbacke 08 für Abus Plus-Schlüssel  
Étau 08 pour clés Abus Plus  
Mordaza 08 para llaves Abus Plus*

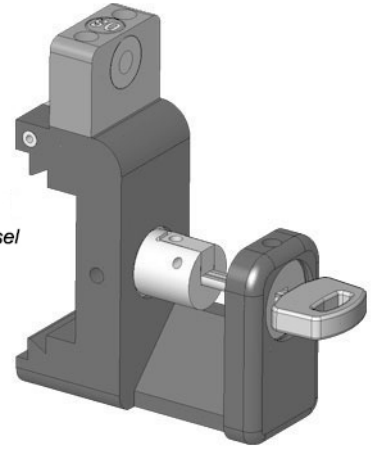

**FALCON**

**OPTIONAL**

**OPZ08763B**

*Morsetto 02 per chiavi Abus  
Jaw 02 for Abus keys  
Spannbacke 02 für Abus Schlüssel  
Étau 02 pour clés Abus  
Mordaza 02 para llaves Abus*

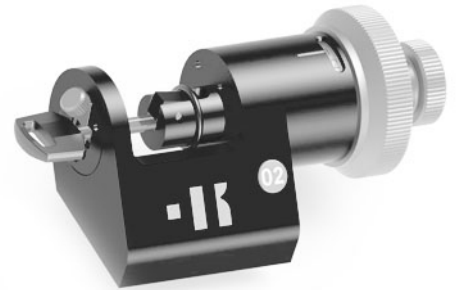

TO  
FIT: **ABUS (D)**



GRANIT



**POWER LYNX  
SIGMA PRO**

**OPTIONAL**

**OPZ05315B**

*Morsetto 07 per chiavi Abus Granit  
Jaw 07 for Abus Granit keys  
Spannbacke 07 für Abus Granit-Schlüssel  
Étau 07 pour clés Abus Granit  
Mordaza 07 para llaves Abus Granit*

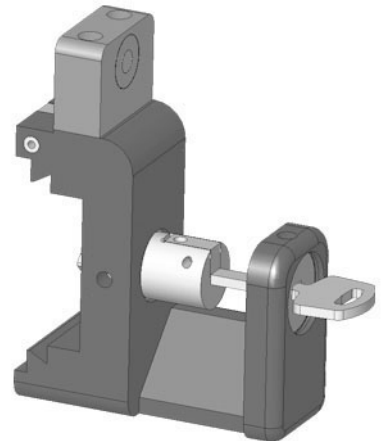

**OPTIONAL**

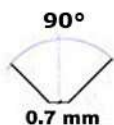

**RIC01791B**  
Fresino HB001  
Cutter HB001  
Fräser HB001  
Fraise HB001  
Fresa HB001



**RIC01792B**  
Tastatore B001  
Tracer Point B001  
Taster B001  
Palpeur B001  
Palpador B001

**STANDARD**

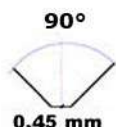

**RIC01793B**  
Fresino HB020  
Cutter HB020  
Fräser HB020  
Fraise HB020  
Fresa HB020



**RIC01794B**  
Tastatore B020  
Tracer Point B020  
Taster B020  
Palpeur B020  
Palpador B020



**303/304/305**



**T-REX  
T-REX ADVANCE**



**PUNTO**

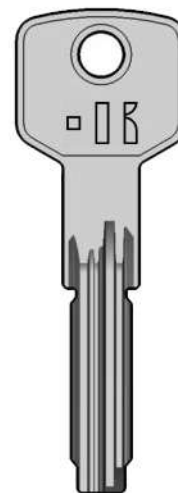

**ABU48**

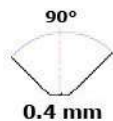

**RIC05044B**  
Fresino V001  
Cutter V001  
Fräser V001  
Fraise V001  
Fresa V001  
**STANDARD**



OR

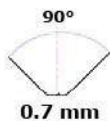

**RIC05618B**  
Fresino V013  
Cutter V013  
Fräser V013  
Fraise V013  
Fresa V013  
**OPTIONAL**

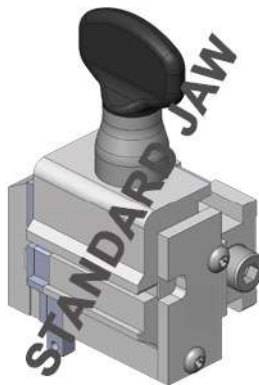

**NINJA TOTAL**



**NINJA VORTEX**



**VERSA**



**BRAVUS**

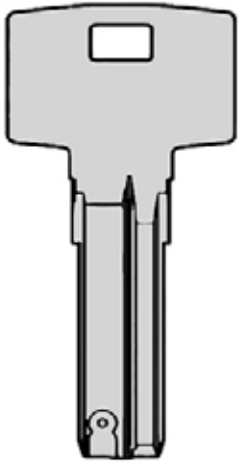

**NINJA TOTAL**



**NINJA VORTEX**



**VERSA**

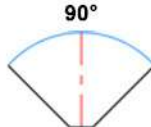

0.2 mm



**RIC09442B**  
 Fresino V044  
 Cutter V044  
 Fräser V044  
 Fraise V044  
 Fresa V044  
**OPTIONAL**

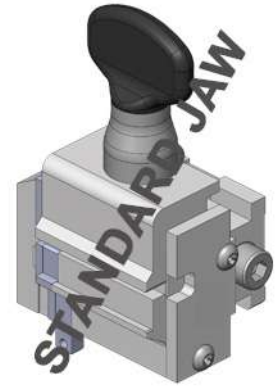

**VITESS**



**DEZMO**

**OPTIONAL**

**OPZ08431B**  
 Morsetto Z19 per chiavi Pfaffenhain  
 Jaw Z19 for Pfaffenhain keys  
 Spannbacke Z19 für Pfaffenhain Schlüssel  
 Étau Z19 pour clés Pfaffenhain  
 Mordaza Z19 para llaves Pfaffenhain

**FOR EDGE CUT**



**NINJA TOTAL**



**NINJA NINJA DARK**

**OPTIONAL**

**OPZ09531B**  
 Morsetto N25  
 Jaw N25  
 Spannbacke N25  
 Étau N25  
 Mordaza N25

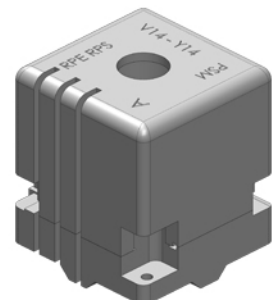

TO  
FIT :

ABUS (D)

OPTIONAL

**OPZ08343B**  
Morsetto 13  
Jaw 13  
Spannbacke 13  
Étau 13  
Mordaza 13

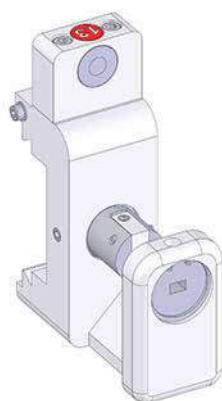

**SIGMA PRO**

**X-Plus**

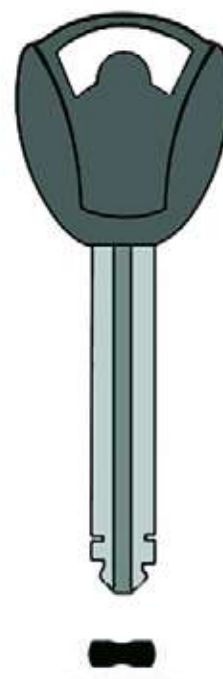

TO  
FIT :

ABUS (D)

OPTIONAL

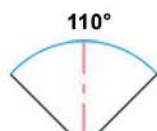

110°

0.3 mm



**RIC05270B**  
Fresino V010  
Cutter V010  
Fräser V010  
Fraise V010  
Fresa V010

**OPZ06039B**  
Morsetto C08  
Jaw C08  
Spannbacke C08  
Étau C08  
Mordaza C08



**NINJA VORTEX**



**VERSA**

**Zolit**





7/9



**303/304/305**



**T-REX  
T-REX ADVANCE**



**PUNTO**



**NINJA TOTAL**



**NINJA VORTEX**



**VERSA**

**OPTIONAL**

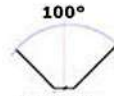

**0.7 mm**

**RIC01789B**  
Fresino HB042  
Cutter HB042  
Fräser HB042  
Fraise HB042  
Fresa HB042



**RIC01790B**  
Tastatore B042  
Tracer Point B042  
Taster B042  
Palpeur B042  
Palpador B042

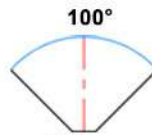

**0.4 mm**

**RIC05264B**  
Fresino V007  
Cutter V007  
Fräser V007  
Fraise V007  
Fresa V007  
OPTIONAL

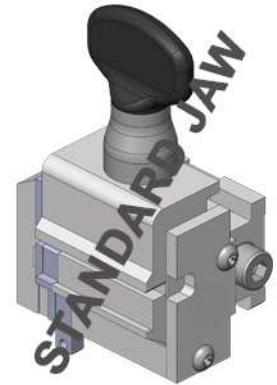



**STANDARD**

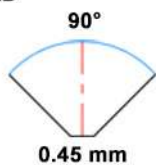

**RIC01793B**  
Fresino HB020  
Cutter HB020  
Fräser HB020  
Fraise HB020  
Fresa HB020



**RIC01794B**  
Tastatore B020  
Tracer Point B020  
Taster B020  
Palpeur B020  
Palpador B020

**OPTIONAL**

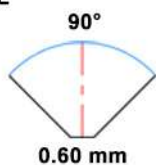

**RIC01785B**  
Fresino HB039  
Cutter HB039  
Fräser HB039  
Fraise HB039  
Fresa HB039



**RIC01786B**  
Tastatore B039  
Tracer Point B039  
Taster B039  
Palpeur B039  
Palpador B039



**303/304/305**



**T-REX  
T-REX ADVANCE**



**PUNTO**

**SCUDO 5000**

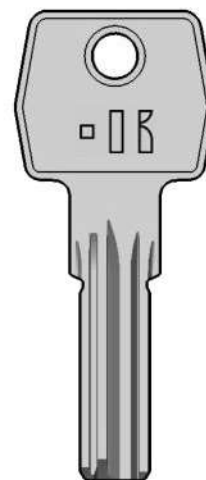

**HNH  
AGB6**

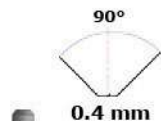

**V001**  
**RIC05044B**  
Fresino V001  
Cutter V001  
Fräser V001  
Fraise V001  
Fresa V001  
**STANDARD**

OR

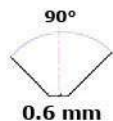

**RIC05612B**  
Fresino V014  
Cutter V014  
Fräser V014  
Fraise V014  
Fresa V014  
**OPTIONAL**

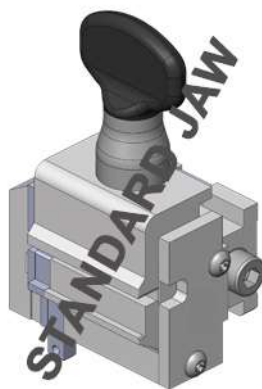

**NINJA TOTAL**



**NINJA VORTEX**



**VERSA**

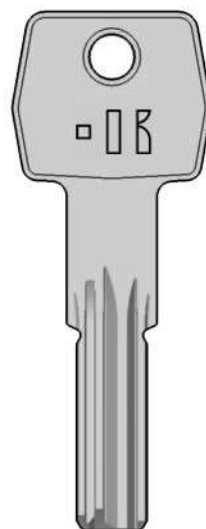

**HNH  
AGB8**

**SCUDO 9000**

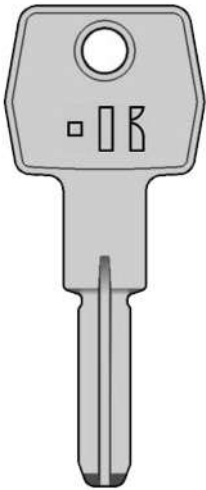

**AGB1**



**303/304/305**

**T-REX  
T-REX ADVANCE**

**PUNTO**



**NINJA TOTAL**

**NINJA VORTEX**

**VERSA**

**OPTIONAL**

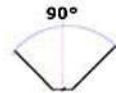

**0.6 mm**

**RIC01785B**  
Fresino HB039  
Cutter HB039  
Fräser HB039  
Fraise HB039  
Fresa HB039



**RIC01786B**  
Tastatore B039  
Tracer Point B039  
Taster B039  
Palpeur B039  
Palpador B039

**STANDARD**

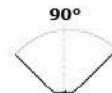

**0.4 mm**

**RIC05044B**  
Fresino V001  
Cutter V001  
Fräser V001  
Fraise V001  
Fresa V001

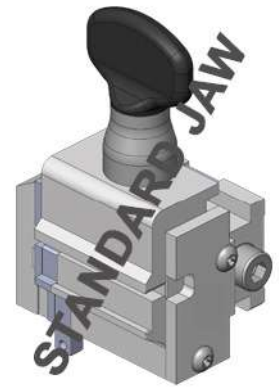

TO  
FIT :

ASSA (S)

**OPZ06039B**  
Morsetto C08  
Jaw C08  
Spannbacke C08  
Étau C08  
Mordaza C08  
**OPTIONAL**



**NINJA VORTEX**



**VERSA**

Flexcore  
Guideline  
Twin  
Serie 600

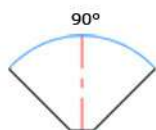

0.40 mm



**RIC05044B**  
Fresino V001  
Cutter V001  
Fräser V001  
Fraise V001  
Fresa V001  
**STANDARD**

OR

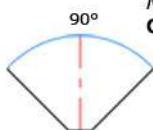

0.70 mm



**RIC05618B**  
Fresino V013  
Cutter V013  
Fräser V013  
Fraise V013  
Fresa V013  
**OPTIONAL**

TO  
FIT :

ASSA (S)

**OPTIONAL**

**OPZ08363B**  
Morsetto Z16 per chiavi ASSA d-12  
Jaw Z16 for ASSA d-12 keys  
Spannbacke Z16 für ASSA d-12 Schlüssel  
Étau Z16 pour clés ASSA d-12  
Mordaza Z16 para llaves ASSA d-12

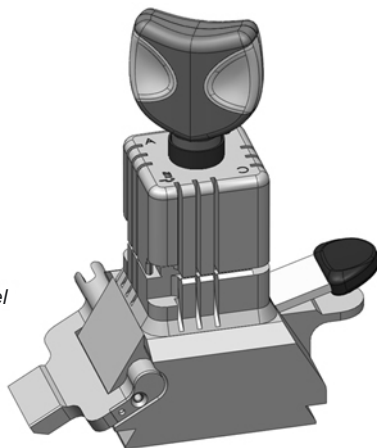

**DEZMO**

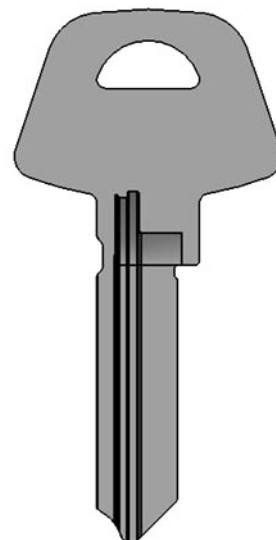

**OPTIONAL**

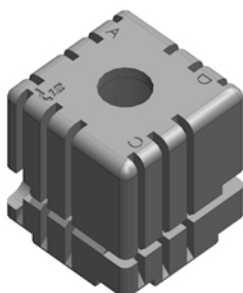

**OPZ08362B**  
Morsetto 4 facce per Assa d-12  
Jaw 4 sides for Assa d-12 keys  
Spannbacke 4 seiten für Assa d-12 Schlüssel  
Étau 4 faces pour clés Assa d-12  
Mordaza 4 lados para llaves Assa d-12



**CARAT/106**



d-12



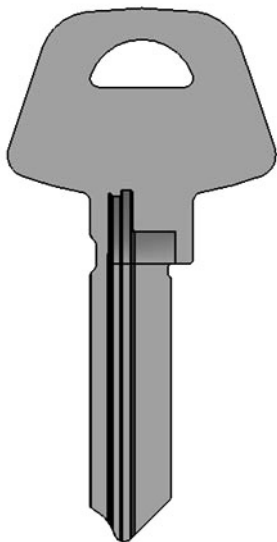

**DROMO**

**OPTIONAL**

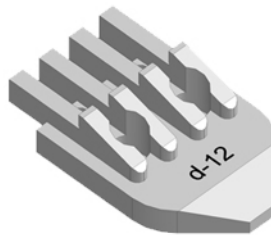

**OPZ08526B**  
*Adattatore Dromo per Assa d-12*  
*Dromo Adaptor for Assa d-12 keys*  
*Dromo Adapter für Assa d-12 Schlüssel*  
*Adaptateur Dromo pour clés Assa d-12*  
*Adaptador Dromo para llaves Assa d-12*

Per i Dromo con matricola inferiore a 17810009999, contattare Keyline.  
 For Dromos with SN before 17810009999, please contact Keyline.  
 Für Dromo mit Seriennummer unter Nummer 17810009999, setzen Sie sich mit Keyline in Verbindung.  
 Pour le Dromo avec matricule inférieure à 17810009999, nous vous prions de contacter Keyline.  
 Para los Dromo con matricula inferior a 17810009999, contactar Keyline.



**NINJA VORTEX**



**VERSA**

**OPTIONAL**

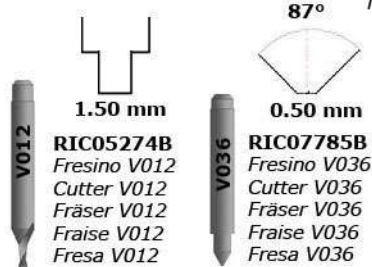

**V012**  
**RIC05274B**  
*Fresino V012*  
*Cutter V012*  
*Fräser V012*  
*Fraise V012*  
*Fresa V012*

**V036**  
**RIC07785B**  
*Fresino V036*  
*Cutter V036*  
*Fräser V036*  
*Fraise V036*  
*Fresa V036*

**OPZ08254B**  
*Morsetto C18*  
*Jaw C18*  
*Spannbacke C18*  
*Étau C18*  
*Mordaza C18*

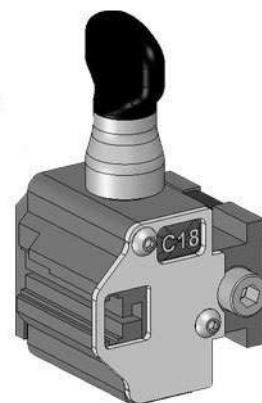

**NINJA LASER**



**NINJA TOTAL**



**NINJA  
NINJA DARK**

**OPTIONAL**

**OPZ09125B**  
*Morsetto N16 per chiavi ASSA d-12*  
*Jaw N16 for ASSA d-12 keys*  
*Spannbacke N16 für ASSA d-12 Schlüssel*  
*Étau N16 pour clés ASSA d-12*  
*Mordaza N16 para llaves ASSA d-12*



TO  
FIT :

ASSA (S)

**OPZ06039B**  
Morsetto C08  
Jaw C08  
Spannbacke C08  
Étau C08  
Mordaza C08  
**OPTIONAL**



**NINJA VORTEX**



**VERSA**

ASSA DP

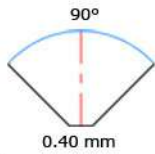
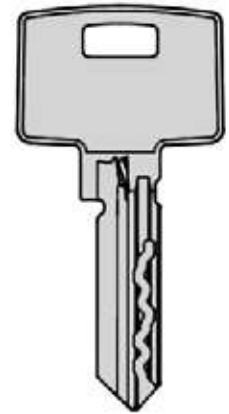

0.40 mm



**RIC05044B**  
Fresino V001  
Cutter V001  
Fräser V001  
Fraise V001  
Fresa V001  
**STANDARD**

OR

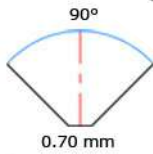

0.70 mm



**RIC05618B**  
Fresino V013  
Cutter V013  
Fräser V013  
Fraise V013  
Fresa V013  
**OPTIONAL**



1.5 mm



**RIC05274B**  
Fresino V012  
Cutter V012  
Fräser V012  
Fraise V012  
Fresa V012  
**OPTIONAL**

TO  
FIT :

ASSA (S)

**OPTIONAL**

**OPZ06039B**  
Morsetto C08  
Jaw C08  
Spannbacke C08  
Étau C08  
Mordaza C08



**NINJA VORTEX**



**VERSA**

Serie 500  
Serie 700

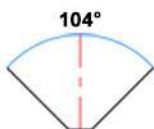
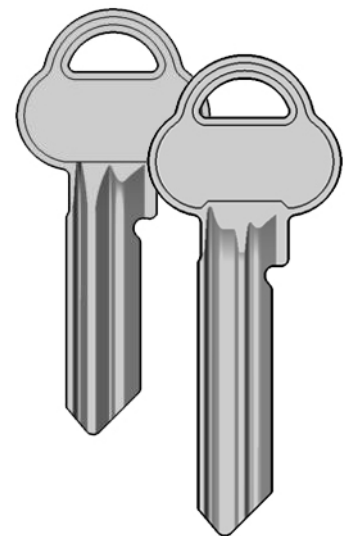

0.40 mm



**RIC06370B**  
Fresino V025  
Cutter V025  
Fräser V025  
Fraise V025  
Fresa V025

TO FIT: ASSA (S)

Guideline



**NINJA TOTAL**



**NINJA VORTEX**



**VERSA**

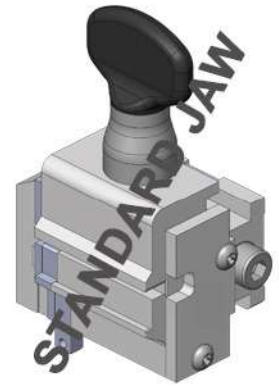
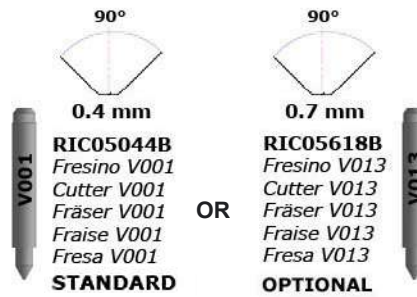

TO FIT: ASSA (S)

**K100**



**NINJA TOTAL**



**NINJA VORTEX**



**VERSA**

**OPTIONAL**



**OPZ10427B**  
Morsetto C39  
Jaw C39  
Spannbacke C39  
Étau C39  
Mordaza C39





TO  
FIT :

ATRA (I)

**OPTIONAL**

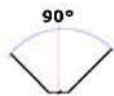

0.6 mm

**RIC01785B**

*Fresino HB039  
Cutter HB039  
Fräser HB039  
Fraise HB039  
Fresa HB039*



**RIC01786B**

*Tastatore B039  
Tracer Point B039  
Taster B039  
Palpeur B039  
Palpador B039*



**303/304/305**



**T-REX  
T-REX ADVANCE**



**PUNTO**

**Power**

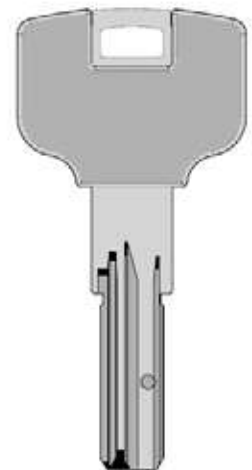

**HNH**



TO  
FIT :

ATRA (I)

**STANDARD**

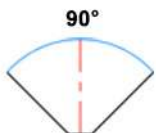

0.45 mm

**RIC01793B**

*Fresino HB020  
Cutter HB020  
Fräser HB020  
Fraise HB020  
Fresa HB020*



**RIC01794B**

*Tastatore B020  
Tracer Point B020  
Taster B020  
Palpeur B020  
Palpador B020*



**303/304/305**



**T-REX  
T-REX ADVANCE**



**PUNTO**

**NEOS  
BOSS**

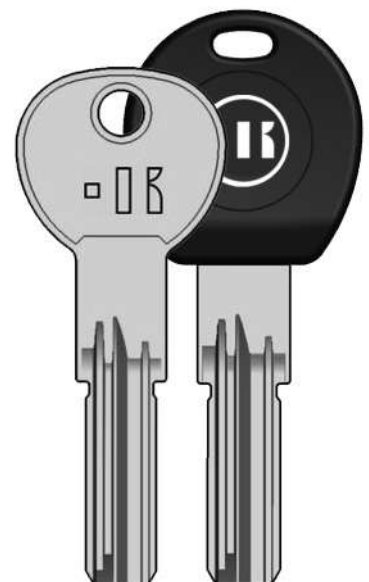

**HNH**

ISE14

ISE15

ISE17

**HNH**

ISE14P

ISE15P

ISE17P

**OPTIONAL**

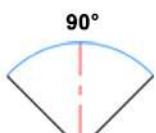

0.60 mm

**RIC01785B**

*Fresino HB039  
Cutter HB039  
Fräser HB039  
Fraise HB039  
Fresa HB039*



**RIC01786B**

*Tastatore B039  
Tracer Point B039  
Taster B039  
Palpeur B039  
Palpador B039*

TO FIT: ATRA (I)

NEOS  
BOSS

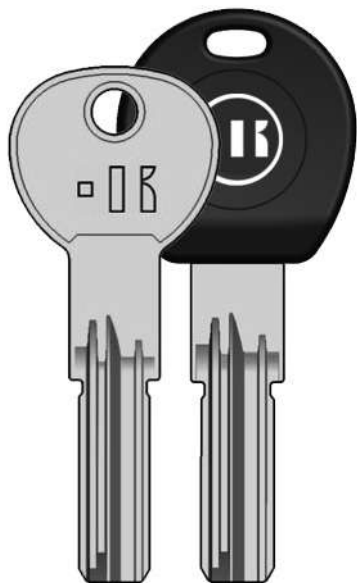

**HNH**    **HNH**  
ISE14    ISE14P  
ISE15    ISE15P  
ISE17    ISE17P



**NINJA TOTAL**



**NINJA VORTEX**



**VERSA**

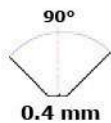

0.4 mm



**RIC05044B**  
*Fresino V001*  
Cutter V001  
Fräser V001  
Fraise V001  
Fresa V001  
**STANDARD**

OR

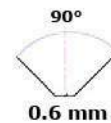

0.6 mm



**RIC05612B**  
*Fresino V014*  
Cutter V014  
Fräser V014  
Fraise V014  
Fresa V014  
**OPTIONAL**

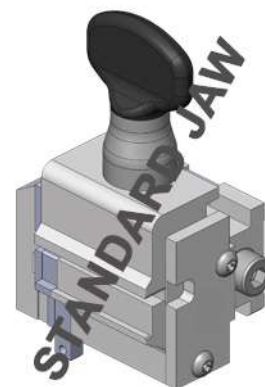

TO FIT: ATRA (I)

NEW POWER

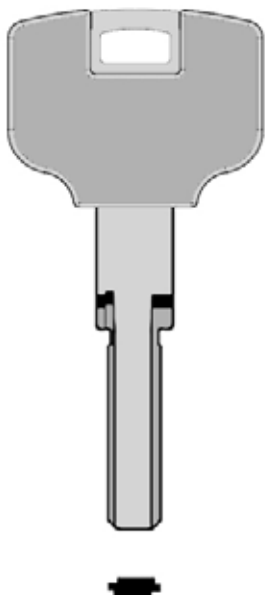

**303/304/305**



**T-REX  
T-REX ADVANCE**



**PUNTO**

**STANDARD**

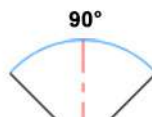

0.45 mm



**RIC01793B**  
*Fresino HB020*  
Cutter HB020  
Fräser HB020  
Fraise HB020  
Fresa HB020



**RIC01794B**  
*Tastatore B020*  
Tracer Point B020  
Taster B020  
Palpeur B020  
Palpador B020

**OPTIONAL**



2,0 mm



**RIC01816B**  
*Fresino HC044*  
Cutter HC044  
Fräser HC044  
Fraise HC044  
Fresa HC044



**RIC01817B**  
*Tastatore C044*  
Tracer Point C044  
Taster C044  
Palpeur C044  
Palpador C044

OPTIONAL



2 mm

**RIC01816B**  
Fresino HC044  
Cutter HC044  
Fräser HC044  
Fraise HC044  
Fresa HC044



**RIC01817B**  
Tastatore C044  
Tracer Point C044  
Taster C044  
Palpeur C044  
Palpador C044



**303/304/305**



**T-REX  
T-REX ADVANCE**



**PUNTO**

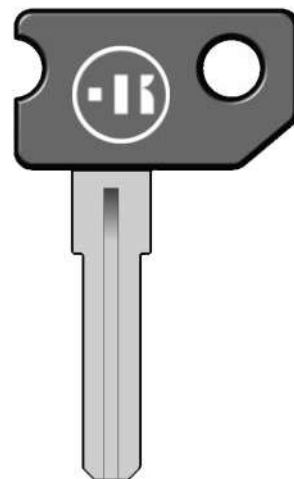

**AXA1P**

OPTIONAL



2.3 mm



**RIC05506B**  
Fresino V016  
Cutter V016  
Fräser V016  
Fraise V016  
Fresa V016



**OPZ04875B**  
Morsetto A03  
Jaw A03  
Spannbacke A03  
Étau A03  
Mordaza A03

**OPZ06511B**  
Adattatore AV06 per chiavi Axa  
Adaptor AV06 for Axa keys  
Adapter AV06 für Axa-Schlüssel  
Adaptateur AV06 pour clés Axa  
Adaptador AV06 para llaves Axa

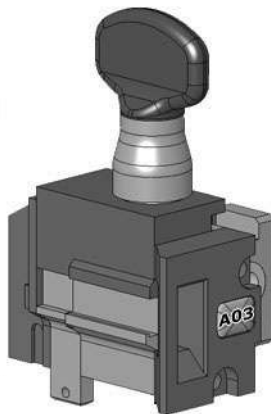

**NINJA TOTAL**



**NINJA VORTEX**



**VERSA**



TO FIT: **AZBE (E)**

HS3/4

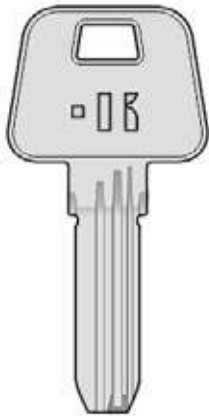

**LIT**  
AZ6



**NINJA TOTAL**



**NINJA VORTEX**



**VERSA**

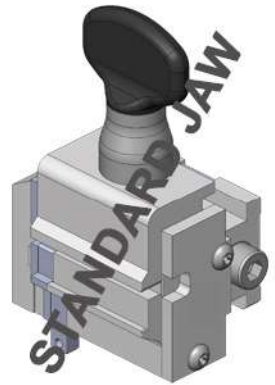
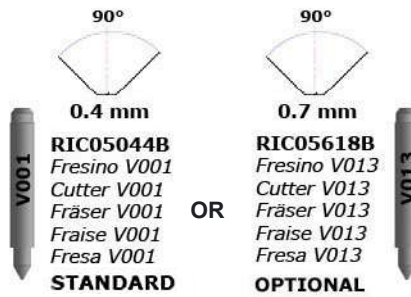

TO FIT: **AZBE (E)**

HS3/HS4  
HS6/HS7

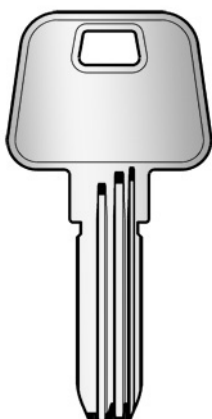

**LIT**



**303/304/305**



**T-REX  
T-REX ADVANCE**



**PUNTO**

**STANDARD**

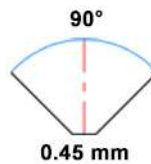

**RIC01793B**  
Fresino HB020  
Cutter HB020  
Fräser HB020  
Fraise HB020  
Fresa HB020

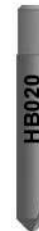

**RIC01794B**  
Tastatore B020  
Tracer Point B020  
Taster B020  
Palpeur B020  
Palpador B020

**OPTIONAL**

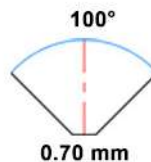

**RIC01789B**  
Fresino HB042  
Cutter HB042  
Fräser HB042  
Fraise HB042  
Fresa HB042

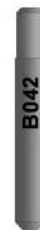

**RIC01790B**  
Tastatore B042  
Tracer Point B042  
Taster B042  
Palpeur B042  
Palpador B042

TO  
FIT :

AZBE (E)

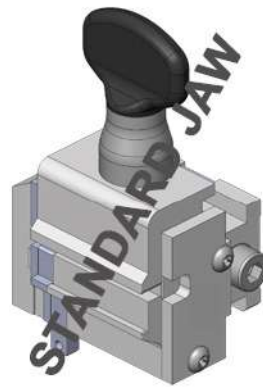
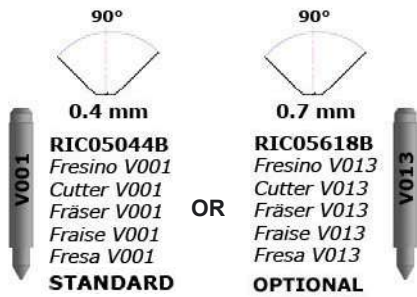

**NINJA TOTAL**



**NINJA VORTEX**



**VERSA**

HS3/HS4  
HS6/HS7

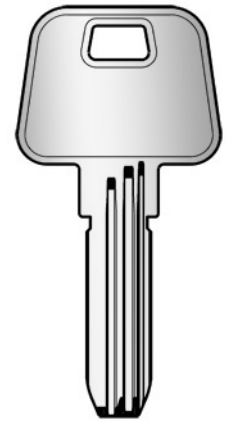

**LIT**

TO  
FIT :

BASI (D)

**STANDARD**

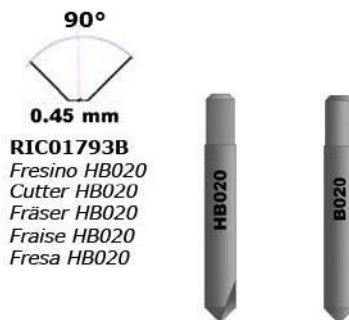

**RIC01794B**  
*Tastatore B020*  
*Tracer Point B020*  
*Taster B020*  
*Palpeur B020*  
*Palpador B020*



**303/304/305**



**T-REX  
T-REX ADVANCE**



**PUNTO**

CX6

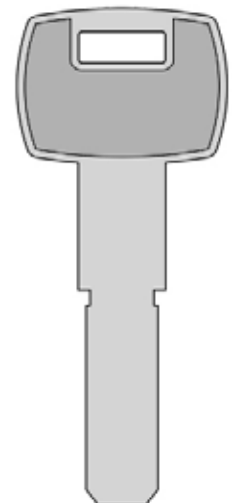

TO FIT: **BASI (D)**

CX6

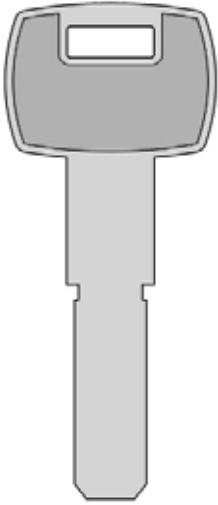

**NINJA TOTAL**



**NINJA VORTEX**



**VERSA**

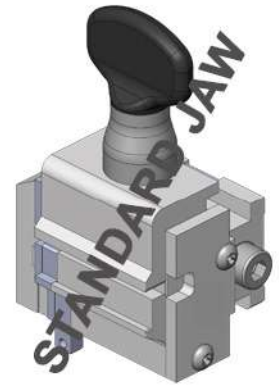
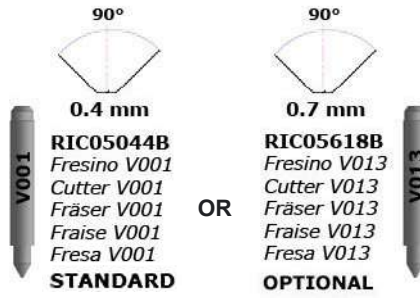

TO FIT: **BASI (D)**



**BA1**



**NINJA VORTEX**



**VERSA**

**OPTIONAL**



**OPZ06039B**  
Morsetto C08  
Jaw C08  
Spannbacke C08  
Étau C08  
Mordaza C08





TO  
FIT :

BKS (D)

**OPTIONAL**



3 mm

**RIC05750B**  
Fresino V017  
Cutter V017  
Fräser V017  
Fraise V017  
Fresa V017



**OPZ05765B**  
Morsetto C05  
Jaw C05  
Spannbacke C05  
Étau C05  
Mordaza C05

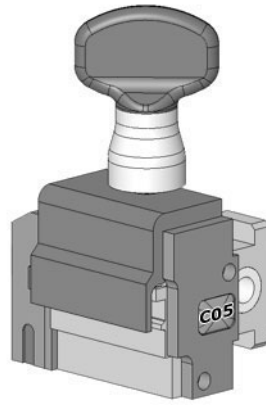

**NINJA TOTAL**



**NINJA VORTEX**



**VERSA**

WS50

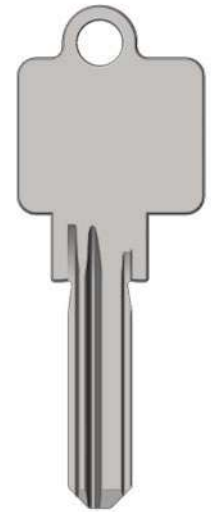

TO  
FIT :

BKS (D)

**OPTIONAL**



3 mm

**RIC05750B**  
Fresino V017  
Cutter V017  
Fräser V017  
Fraise V017  
Fresa V017



**OPZ05767B**  
Morsetto C06  
Jaw C06  
Spannbacke C06  
Étau C06  
Mordaza C06

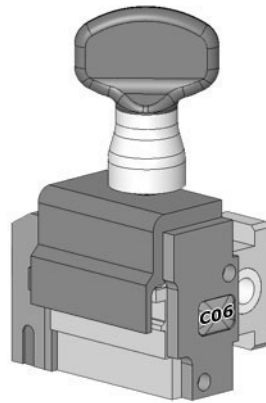

**NINJA TOTAL**



**NINJA VORTEX**



**VERSA**

WS50 MK

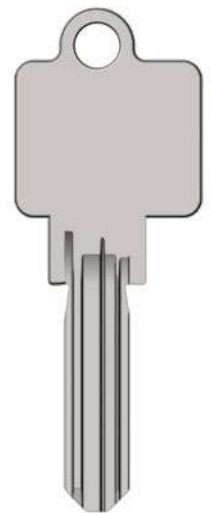

TO FIT: **BRICARD (F)**



**JIT**  
BD16  
BD13  
BD21



**OPTIONAL**

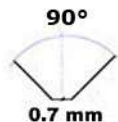

**RIC01791B**  
*Fresino HB001  
Cutter HB001  
Fräser HB001  
Fraise HB001  
Fresa HB001*



**RIC01792B**  
*Tastatore B001  
Tracer Point B001  
Taster B001  
Palpeur B001  
Palpador B001*

**STANDARD**

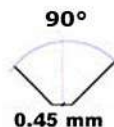

**RIC01793B**  
*Fresino HB020  
Cutter HB020  
Fräser HB020  
Fraise HB020  
Fresa HB020*



**RIC01794B**  
*Tastatore B020  
Tracer Point B020  
Taster B020  
Palpeur B020  
Palpador B020*

TO FIT: **BRICARD (F)**

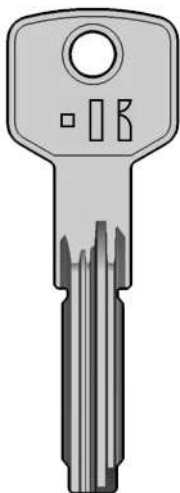

**JIT**  
BD20



**STANDARD**

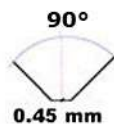

**RIC01793B**  
*Fresino HB020  
Cutter HB020  
Fräser HB020  
Fraise HB020  
Fresa HB020*



**RIC01794B**  
*Tastatore B020  
Tracer Point B020  
Taster B020  
Palpeur B020  
Palpador B020*

TO  
FIT :

BRICARD (F)

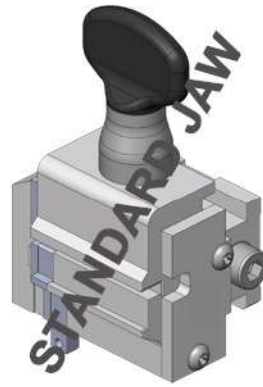
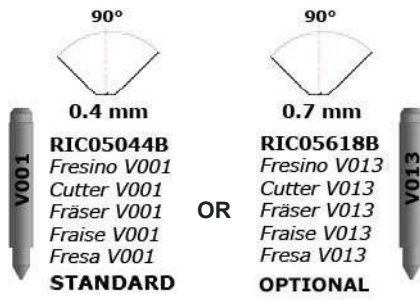

**NINJA TOTAL**



**NINJA VORTEX**



**VERSA**

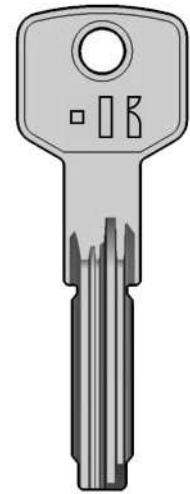

**BD20**

TO  
FIT :

BRIDGESTONE (J)

**OPTIONAL**

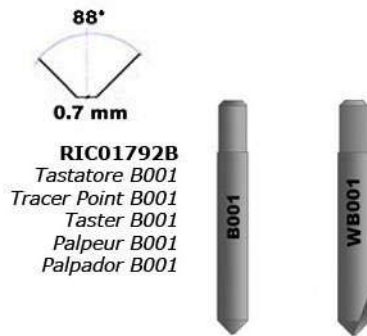

**304/305**



**T-REX  
T-REX ADVANCE**



**PUNTO**



**WVI**



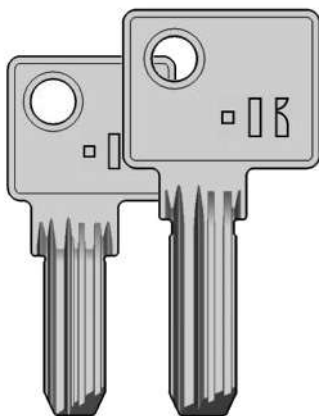

**BU12**      **BU13**



**303/304/305**

**T-REX  
T-REX ADVANCE**

**PUNTO**

**OPTIONAL**

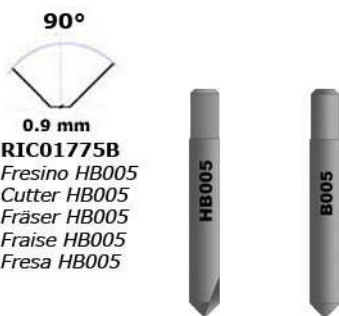

**90°**  
**0.9 mm**  
**RIC01775B**  
*Fresino HB005  
Cutter HB005  
Fräser HB005  
Fraise HB005  
Fresa HB005*

**RIC01776B**  
*Tastatore B005  
Tracer Point B005  
Taster B005  
Palpeur B005  
Palpador B005*

**STANDARD**

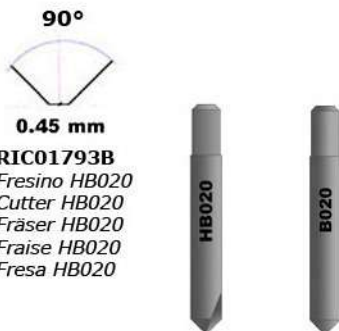

**90°**  
**0.45 mm**  
**RIC01793B**  
*Fresino HB020  
Cutter HB020  
Fräser HB020  
Fraise HB020  
Fresa HB020*

**RIC01794B**  
*Tastatore B020  
Tracer Point B020  
Taster B020  
Palpeur B020  
Palpador B020*



**NINJA TOTAL**

**NINJA VORTEX**

**VERSA**

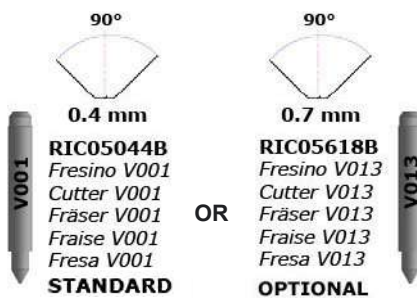

**0.4 mm**  
**RIC05044B**  
*Fresino V001  
Cutter V001  
Fräser V001  
Fraise V001  
Fresa V001*  
**STANDARD**

OR

**0.7 mm**  
**RIC05618B**  
*Fresino V013  
Cutter V013  
Fräser V013  
Fraise V013  
Fresa V013*  
**OPTIONAL**

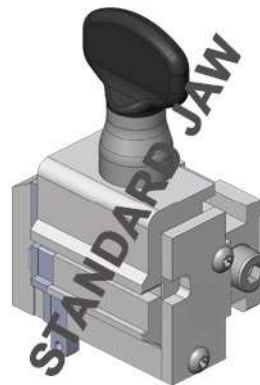

**OPTIONAL**

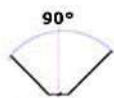

0.6 mm

**RIC01785B**  
Fresino HB039  
Cutter HB039  
Fräser HB039  
Fraise HB039  
Fresa HB039



**RIC01786B**  
Tastatore B039  
Tracer Point B039  
Taster B039  
Palpeur B039  
Palpador B039



**303/304/305**



**T-REX  
T-REX ADVANCE**



**PUNTO**

WS

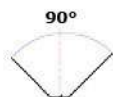
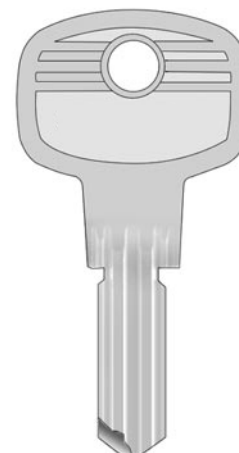

0.4 mm

**RIC05044B**  
Fresino V001  
Cutter V001  
Fräser V001  
Fraise V001  
Fresa V001  
**STANDARD**

OR

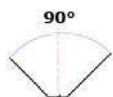

0.6 mm

**RIC05612B**  
Fresino V014  
Cutter V014  
Fräser V014  
Fraise V014  
Fresa V014  
**OPTIONAL**

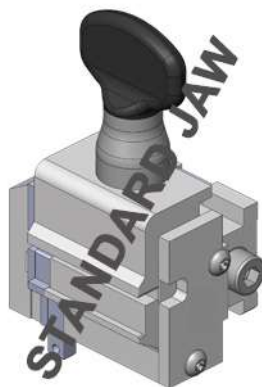

**NINJA TOTAL**



**NINJA VORTEX**



**VERSA**

PSM  
UDM

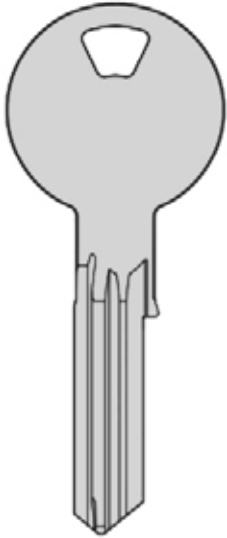

**NINJA LASER**



**NINJA TOTAL**



**NINJA  
NINJA DARK**

**OPTIONAL**

**OPZ09531B**  
Morsetto N25  
Jaw N25  
Spannbacke N25  
Étau N25  
Mordaza N25

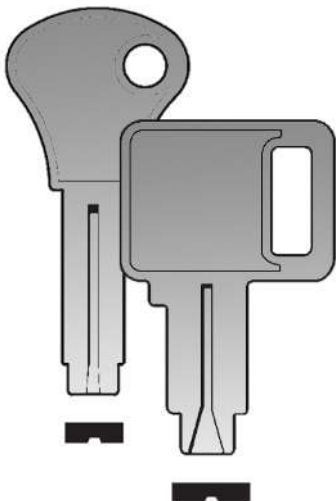
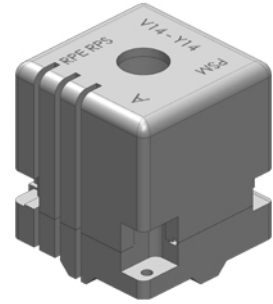

**206**

**OPTIONAL**

**OPZ06365B**  
Morsetti per chiavi CHUBB  
Jaws for CHUBB keys  
Spannbacken für CHUBB  
Étaux pour clés CHUBB  
Mordazas para CHUBB

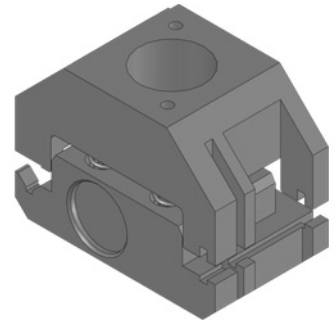

TO  
FIT :

CHUBB (GB)

OPTIONAL

**OPZ08389B**  
Morsetto 14  
Jaw 14  
Spannbacke 14  
Étau 14  
Mordaza 14

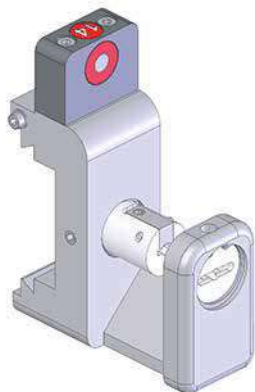

**SIGMA PRO**

**Ava**



TO  
FIT :

CISA (I)

OPTIONAL

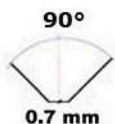

**0.7 mm**

**RIC01791B**  
Fresino HB001  
Cutter HB001  
Fräser HB001  
Fraise HB001  
Fresa HB001



**RIC01792B**  
Tastatore B001  
Tracer Point B001  
Taster B001  
Palpeur B001  
Palpador B001

STANDARD

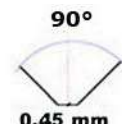

**0.45 mm**

**RIC01793B**  
Fresino HB020  
Cutter HB020  
Fräser HB020  
Fraise HB020  
Fresa HB020



**RIC01794B**  
Tastatore B020  
Tracer Point B020  
Taster B020  
Palpeur B020  
Palpador B020



**303/304/305**



**PUNTO**

**Astral Tekno**

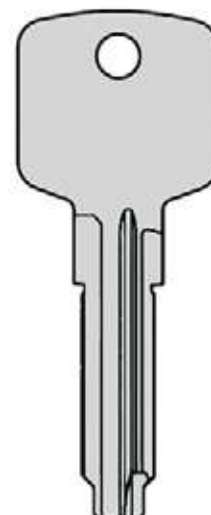

**OPZ10656B**

Adattatore AD07 per chiavi Cisa Astral Tekno  
Adaptor AD07 for Cisa Astral Tekno keys  
Adapter AD07 für Cisa Astral Tekno-Schlüssel  
Adaptateur AD07 pour clés Cisa Astral Tekno  
Adaptador AD07 para llaves Cisa Astral Tekno

OPTIONAL





Astral Tekno

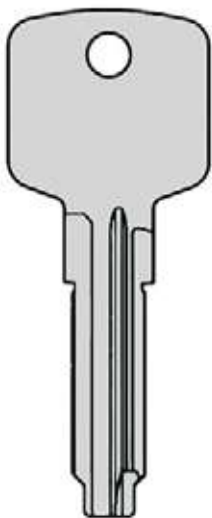

**T-REX  
T-REX ADVANCE**

**OPTIONAL**

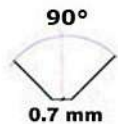

**RIC01791B**  
Fresino HB001  
Cutter HB001  
Fräser HB001  
Fraise HB001  
Fresa HB001



**RIC01792B**  
Tastatore B001  
Tracer Point B001  
Taster B001  
Palpeur B001  
Palpador B001

**STANDARD**

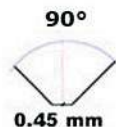

**RIC01793B**  
Fresino HB020  
Cutter HB020  
Fräser HB020  
Fraise HB020  
Fresa HB020



**RIC01794B**  
Tastatore B020  
Tracer Point B020  
Taster B020  
Palpeur B020  
Palpador B020



**NINJA TOTAL**



**NINJA VORTEX**



**VERSA**

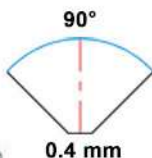

**RIC05044B**  
Fresino V001  
Cutter V001  
Fräser V001  
Fraise V001  
Fresa V001  
**STANDARD**



OR

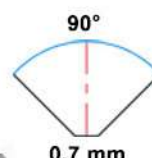

**RIC05618B**  
Fresino V013  
Cutter V013  
Fräser V013  
Fraise V013  
Fresa V013  
**OPTIONAL**

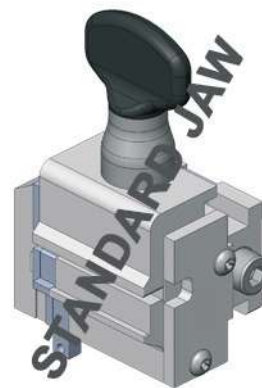

**OPZ10271B**  
Adattatore AV09 per chiavi Cisa  
Adaptor AV09 for Cisa keys  
Adapter AV09 für Cisa-Schlüssel  
Adaptateur AV09 pour clés Cisa  
Adaptador AV09 para llaves Cisa  
**OPTIONAL**



TO  
FIT :

CISA (I)

**OPTIONAL**

**OPZ08624B**

Morsetto Z21 per chiavi SP-TSP  
Jaw Z21 for SP-TSP keys  
Spannbacke Z21 für SP-TSP Schlüssel  
Étau Z21 pour clés SP-TSP  
Mordaza Z21 para llaves SP-TSP

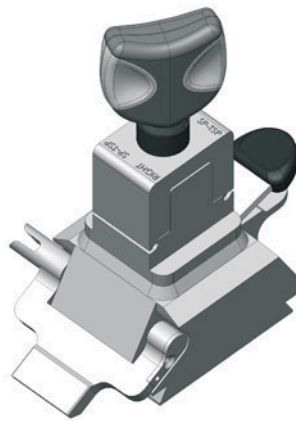

**DEZMO**

SP/TSP

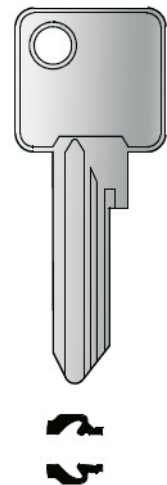

TO  
FIT :

CISA (I)

**OPTIONAL**

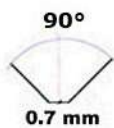

**RIC01791B**  
Fresino HB001  
Cutter HB001  
Fräser HB001  
Fraise HB001  
Fresa HB001



**RIC01792B**  
Tastatore B001  
Tracer Point B001  
Taster B001  
Palpeur B001  
Palpador B001

**STANDARD**

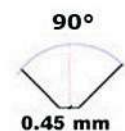

**RIC01793B**  
Fresino HB020  
Cutter HB020  
Fräser HB020  
Fraise HB020  
Fresa HB020



**RIC01794B**  
Tastatore B020  
Tracer Point B020  
Taster B020  
Palpeur B020  
Palpador B020



**303/304/305**



**T-REX  
T-REX ADVANCE**



**PUNTO**

NEW ASTRAL

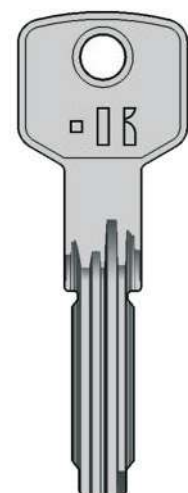

CA62

**NEW ASTRAL**

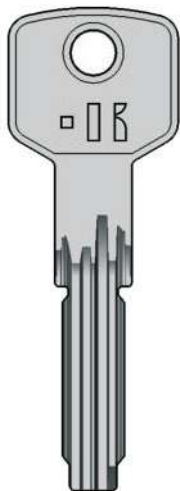

  
CA62



**NINJA TOTAL**



**NINJA VORTEX**



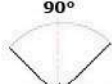

**VERSA**

90°  0.4 mm  
**RIC05044B**  
*Fresino V001*  
*Cutter V001*  
*Fräser V001*  
*Fraise V001*  
*Fresa V001*  
**STANDARD**

OR

90°  0.7 mm  
**RIC05618B**  
*Fresino V013*  
*Cutter V013*  
*Fräser V013*  
*Fraise V013*  
*Fresa V013*  
**OPTIONAL**

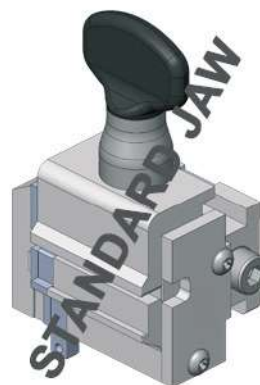

**AXIS**

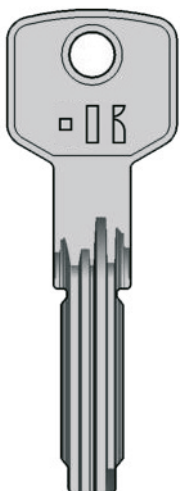

  
CA70



**303/304/305**



**T-REX  
T-REX ADVANCE**



**PUNTO**

**OPTIONAL**

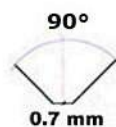

**RIC01791B**  
*Fresino HB001*  
*Cutter HB001*  
*Fräser HB001*  
*Fraise HB001*  
*Fresa HB001*



**RIC01792B**  
*Tastatore B001*  
*Tracer Point B001*  
*Taster B001*  
*Palpeur B001*  
*Palpador B001*

**STANDARD**



**RIC01793B**  
*Fresino HB020*  
*Cutter HB020*  
*Fräser HB020*  
*Fraise HB020*  
*Fresa HB020*



**RIC01794B**  
*Tastatore B020*  
*Tracer Point B020*  
*Taster B020*  
*Palpeur B020*  
*Palpador B020*

TO  
FIT :

CISA (I)

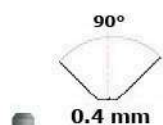

0.4 mm

**RIC05044B**  
Fresino V001  
Cutter V001  
Fräser V001  
Fraise V001  
Fresa V001  
**STANDARD**

OR

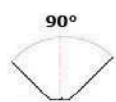

0.7 mm

**RIC05618B**  
Fresino V013  
Cutter V013  
Fräser V013  
Fraise V013  
Fresa V013  
**OPTIONAL**

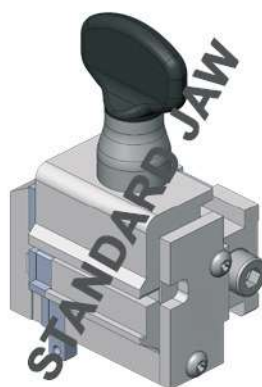

**NINJA TOTAL**



**NINJA VORTEX**



**VERSA**

AXIS

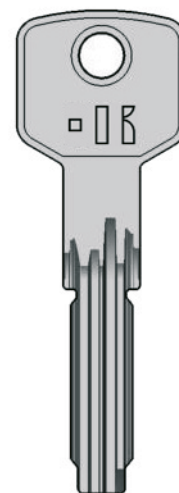

CA70

TO  
FIT :

CISA (I)

**OPTIONAL**

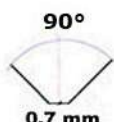

0.7 mm

**RIC01791B**  
Fresino HB001  
Cutter HB001  
Fräser HB001  
Fraise HB001  
Fresa HB001



**RIC01792B**  
Tastatore B001  
Tracer Point B001  
Taster B001  
Palpeur B001  
Palpador B001

**STANDARD**

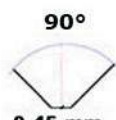

0.45 mm

**RIC01793B**  
Fresino HB020  
Cutter HB020  
Fräser HB020  
Fraise HB020  
Fresa HB020



**RIC01794B**  
Tastatore B020  
Tracer Point B020  
Taster B020  
Palpeur B020  
Palpador B020



**303/304/305**



**T-REX  
T-REX ADVANCE**



**PUNTO**

AP3/AP4

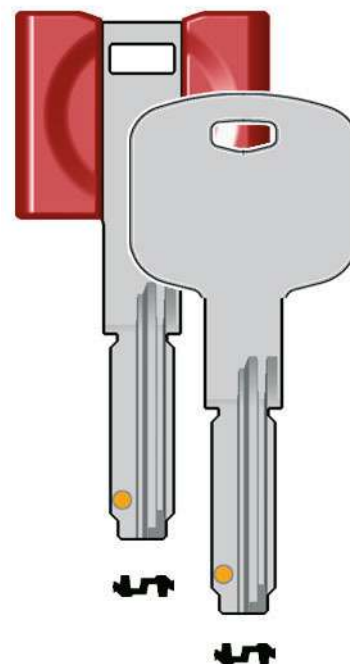



TO FIT: CISA (I)

AP3/AP4

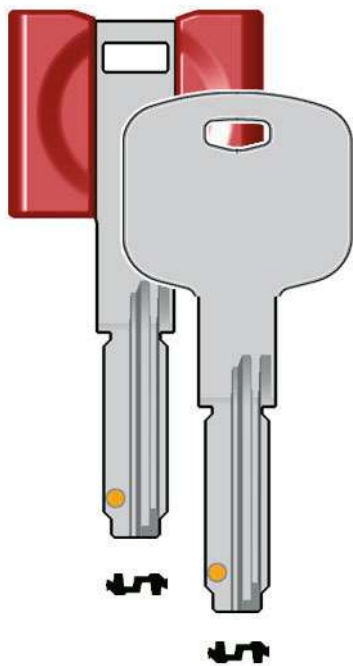

NINJA TOTAL



NINJA VORTEX



VERSA

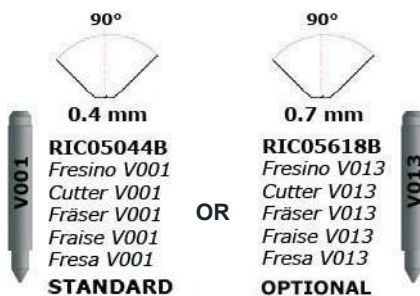

**RIC05044B**  
Fresino V001  
Cutter V001  
Fräser V001  
Fraise V001  
Fresa V001  
**STANDARD**

OR

**RIC05618B**  
Fresino V013  
Cutter V013  
Fräser V013  
Fraise V013  
Fresa V013  
**OPTIONAL**

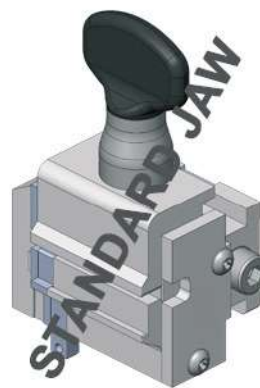

TO FIT: CISA (I)

ASTRAL

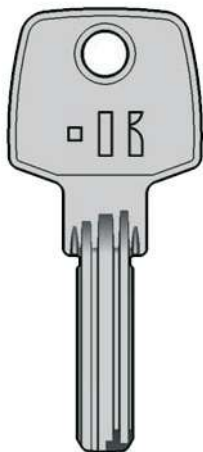

CA48



303/304/305



T-REX  
T-REX ADVANCE



PUNTO

OPTIONAL

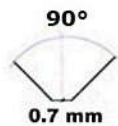

**RIC01791B**  
Fresino HB001  
Cutter HB001  
Fräser HB001  
Fraise HB001  
Fresa HB001



**RIC01792B**  
Tastatore B001  
Tracer Point B001  
Taster B001  
Palpeur B001  
Palpador B001

STANDARD

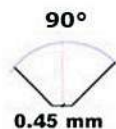

**RIC01793B**  
Fresino HB020  
Cutter HB020  
Fräser HB020  
Fraise HB020  
Fresa HB020



**RIC01794B**  
Tastatore B020  
Tracer Point B020  
Taster B020  
Palpeur B020  
Palpador B020

TO  
FIT :

CISA (I)



0.4 mm

**RIC05044B**  
Fresino V001  
Cutter V001  
Fräser V001  
Fraise V001  
Fresa V001  
**STANDARD**

OR

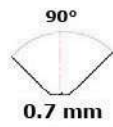

0.7 mm

**RIC05618B**  
Fresino V013  
Cutter V013  
Fräser V013  
Fraise V013  
Fresa V013  
**OPTIONAL**

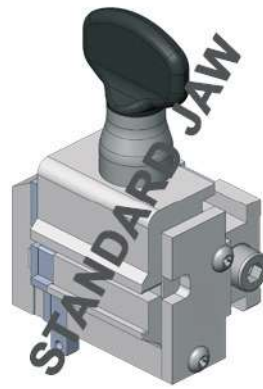

**NINJA TOTAL**



**NINJA VORTEX**



**VERSA**

**ASTRAL**

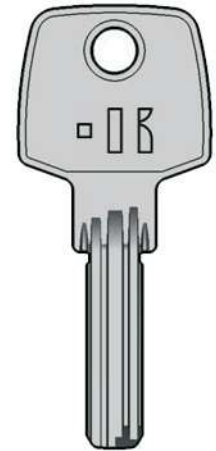

**CA48**

TO  
FIT :

CITY (F)

**OPTIONAL**

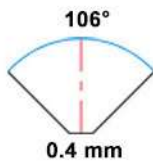

0.4 mm



**RIC05266B**  
Fresino V008  
Cutter V008  
Fräser V008  
Fraise V008  
Fresa V008

**OPZ06039B**  
Morsetto C08  
Jaw C08  
Spannbacke C08  
Étau C08  
Mordaza C08



**NINJA VORTEX**



**VERSA**



**ISE5S**

TO FIT: **CODEM (F)**



**FTH12**



**OPTIONAL**

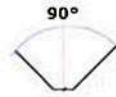

0.9 mm

**RIC01775B**  
*Fresino HB005  
 Cutter HB005  
 Fräser HB005  
 Fraise HB005  
 Fresa HB005*



**RIC01776B**  
*Tastatore B005  
 Tracer Point B005  
 Taster B005  
 Palpeur B005  
 Palpador B005*

TO FIT: **CORBIN (I)**

**Euroval**

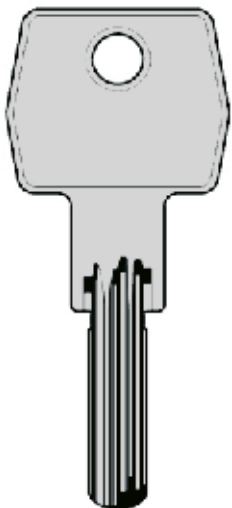

**OPTIONAL**

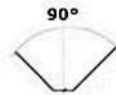

0.9 mm

**RIC01775B**  
*Fresino HB005  
 Cutter HB005  
 Fräser HB005  
 Fraise HB005  
 Fresa HB005*



**RIC01776B**  
*Tastatore B005  
 Tracer Point B005  
 Taster B005  
 Palpeur B005  
 Palpador B005*

TO  
FIT :

CORBIN (I)

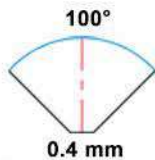

**RIC05264B**  
 Fresino V007  
 Cutter V007  
 Fräser V007  
 Fraise V007  
 Fresa V007  
 OPTIONAL

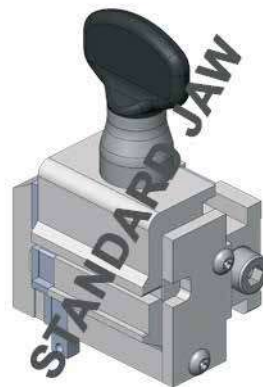

**NINJA TOTAL**



**NINJA VORTEX**



**VERSA**

Goldstar



ML13P

TO  
FIT :

CORBIN (I)

**STANDARD**

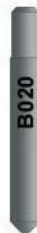
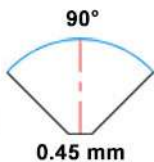

**RIC01793B**  
 Fresino HB020  
 Cutter HB020  
 Fräser HB020  
 Fraise HB020  
 Fresa HB020

**RIC01794B**  
 Tastatore B020  
 Tracer Point B020  
 Taster B020  
 Palpeur B020  
 Palpador B020



**303/304/305**



**T-REX  
T-REX ADVANCE**



**PUNTO**

EUROSTAR

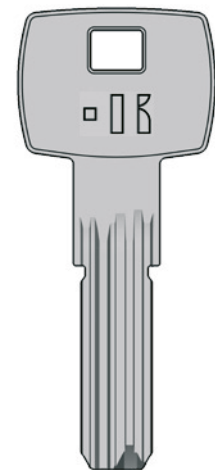

COR87

**OPTIONAL**

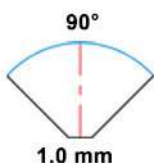

**RIC01822B**  
 Fresino HB043  
 Cutter HB043  
 Fräser HB043  
 Fraise HB043  
 Fresa HB043

**RIC01823B**  
 Tastatore B043  
 Tracer Point B043  
 Taster B043  
 Palpeur B043  
 Palpador B043



TO FIT: **CORBIN (I)**

**EUROSTAR**

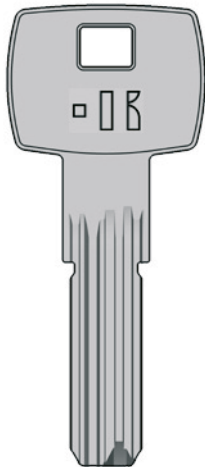

**NINJA TOTAL**



**NINJA VORTEX**





**VERSA**

90°  90°

**0.4 mm**  
**RIC05044B**  
*Fresino V001*  
*Cutter V001*  
*Fräser V001*  
*Fraise V001*  
*Fresa V001*  
**STANDARD**

OR

**0.7 mm**  
**RIC05618B**  
*Fresino V013*  
*Cutter V013*  
*Fräser V013*  
*Fraise V013*  
*Fresa V013*  
**OPTIONAL**

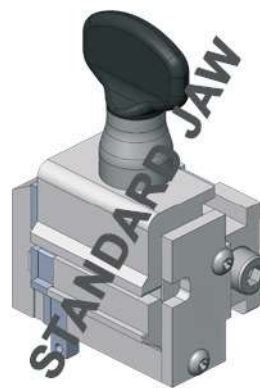
TO FIT: **CORNI (I)**

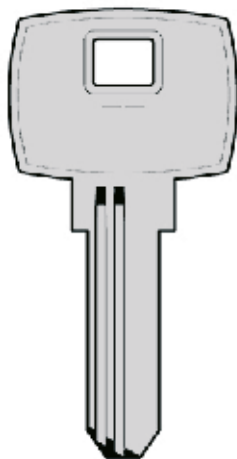

**303/304/305**



**T-REX**  
**T-REX ADVANCE**



**PUNTO**

**OPTIONAL**

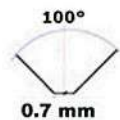

**RIC01789B**  
*Fresino HB042*  
*Cutter HB042*  
*Fräser HB042*  
*Fraise HB042*  
*Fresa HB042*



**RIC01790B**  
*Tastatore B042*  
*Tracer Point B042*  
*Taster B042*  
*Palpeur B042*  
*Palpador B042*

**STANDARD**

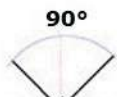

0.45 mm

**RIC01793B**  
Fresino HB020  
Cutter HB020  
Fräser HB020  
Fraise HB020  
Fresa HB020



**RIC01794B**  
Tastatore B020  
Tracer Point B020  
Taster B020  
Palpeur B020  
Palpador B020



**303/304/305**



**T-REX  
T-REX ADVANCE**



**PUNTO**

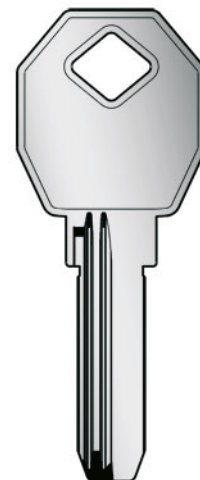

**KEYLINE**

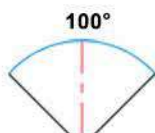

0.4 mm

**RIC05264B**  
Fresino V007  
Cutter V007  
Fräser V007  
Fraise V007  
Fresa V007  
OPTIONAL

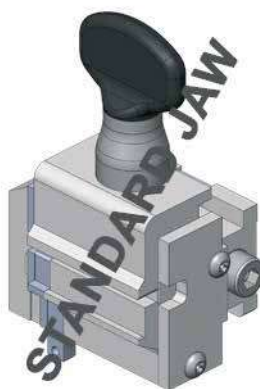

**NINJA TOTAL**



**NINJA VORTEX**



**VERSA**



AS37HH



NINJA VORTEX



VERSA

OPTIONAL

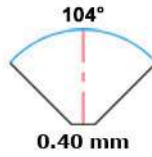

**RIC06370B**  
Fresino V025  
Cutter V025  
Fräser V025  
Fraise V025  
Fresa V025

**OPZ06039B**  
Morsetto C08  
Jaw C08  
Spannbacke C08  
Étau C08  
Mordaza C08

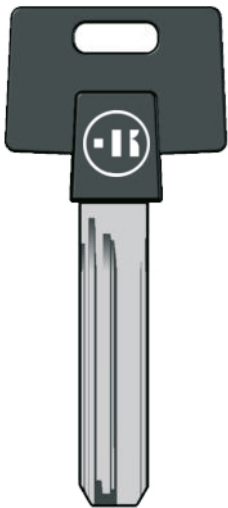

ML4P



303/304/305



T-REX  
T-REX ADVANCE



PUNTO

STANDARD

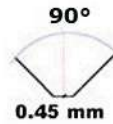

**RIC01793B**  
Fresino HB020  
Cutter HB020  
Fräser HB020  
Fraise HB020  
Fresa HB020



**RIC01794B**  
Tastatore B020  
Tracer Point B020  
Taster B020  
Palpeur B020  
Palpador B020

TO  
FIT :

# DEFEND LOCK (CZ)

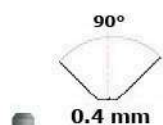

0.4 mm

**RIC05044B**  
Fresino V001  
Cutter V001  
Fräser V001  
Fraise V001  
Fresa V001  
**STANDARD**

OR

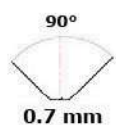

0.7 mm

**RIC05618B**  
Fresino V013  
Cutter V013  
Fräser V013  
Fraise V013  
Fresa V013  
**OPTIONAL**

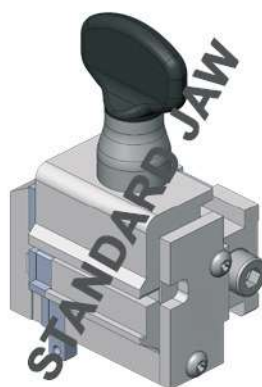

**NINJA TOTAL**



**NINJA VORTEX**



**VERSA**

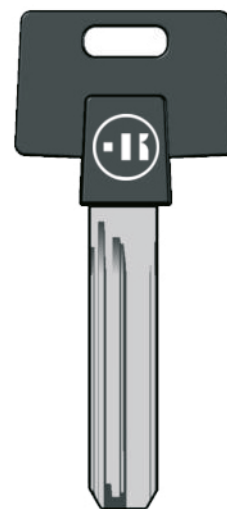

**ML4P**

TO  
FIT :

# DELCA (GR)

**OPTIONAL**

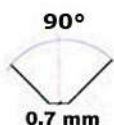

0.7 mm

**RIC01791B**  
Fresino HB001  
Cutter HB001  
Fräser HB001  
Fraise HB001  
Fresa HB001



**RIC01792B**  
Tastatore B001  
Tracer Point B001  
Taster B001  
Palpeur B001  
Palpador B001

**STANDARD**

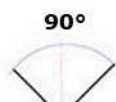

0.45 mm

**RIC01793B**  
Fresino HB020  
Cutter HB020  
Fräser HB020  
Fraise HB020  
Fresa HB020



**RIC01794B**  
Tastatore B020  
Tracer Point B020  
Taster B020  
Palpeur B020  
Palpador B020



**303/304/305**



**T-REX  
T-REX ADVANCE**



**PUNTO**

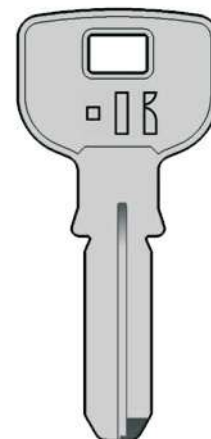

**DL1S**

**DL2**



TO FIT: **DIERRE (I)**

NEW POWER

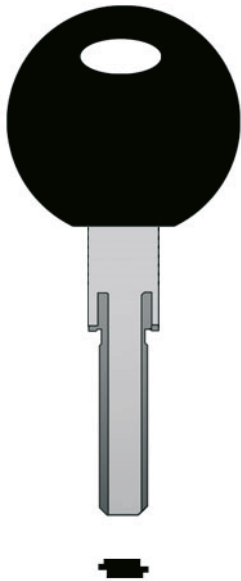

**NINJA TOTAL**



**NINJA VORTEX**



**VERSA**

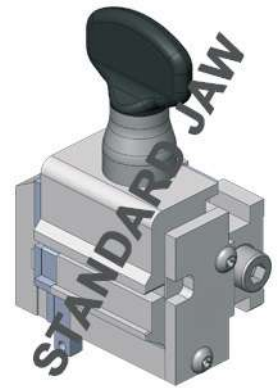
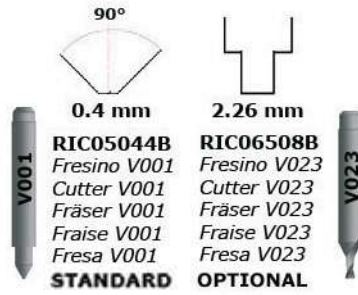

TO FIT: **DOM (D)**

IXDAS



**NINJA TOTAL**



**NINJA VORTEX**



**VERSA**

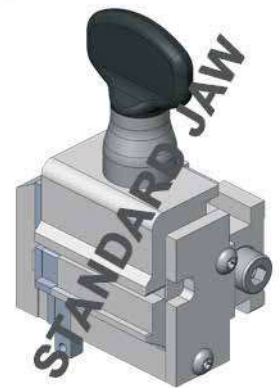

OPTIONAL

**OPZ09553B**

Morsetto Z23 per chiavi DOM  
Jaw Z23 for DOM Keys  
Spannbacke Z23 für DOM-Schlüssel  
Étau Z23 pour clés DOM  
Mordaza Z23 para llaves DOM

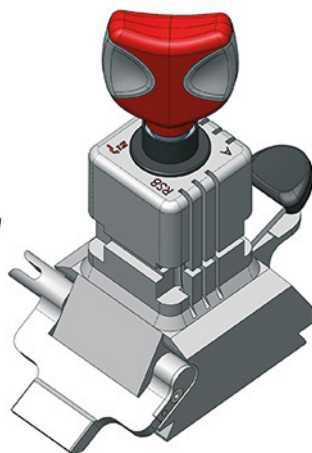

**DEZMO**

RS8

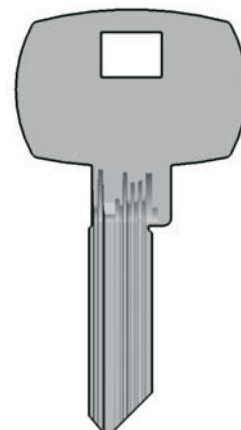

OPTIONAL

**OPZ07332B**

Morsetto C14  
Jaw C14  
Spannbacke C14  
Étau C14  
Mordaza C14

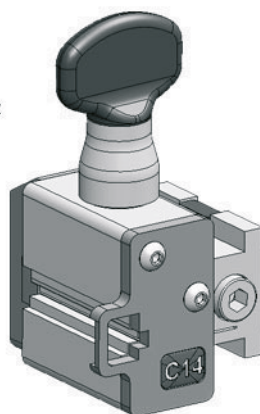

96°

0.4 mm



**RIC05262B**

Fresino V006  
Cutter V006  
Fräser V006  
Fraise V006  
Fresa V006



**NINJA TOTAL**



**NINJA VORTEX**



**VERSA**



PATENTED  
KEYBLANK  
®

TO FIT: **DOM (D)**

**IXEZ**

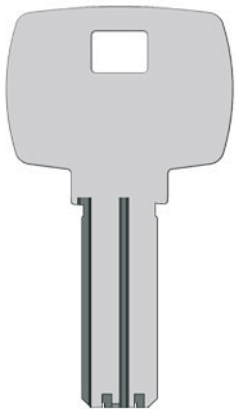

(51)



**NINJA TOTAL**



**NINJA VORTEX**



**VERSA**

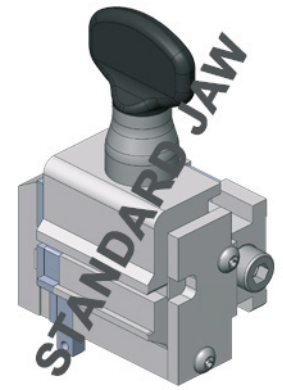
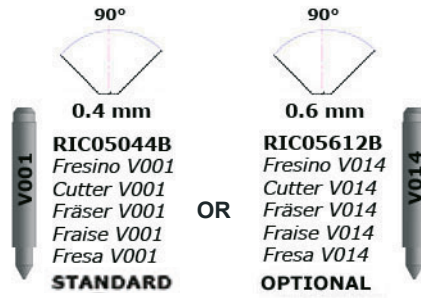

TO FIT: **DOM (D)**

**IX6SR**

**IX5DAS**

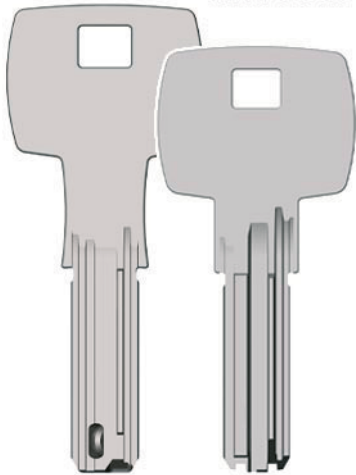

(132)  
(232)  
(233)

(038)

(038) (132)  
(061) (230)  
(101) (234)  
(115) (240)  
(128) (241)  
(130)



**NINJA TOTAL**



**NINJA VORTEX**



**VERSA**

**OPTIONAL**



**OPZ05701B**  
*Morsetto C03*  
*Jaw C03*  
*Spannbacke C03*  
*Étau C03*  
*Mordaza C03*

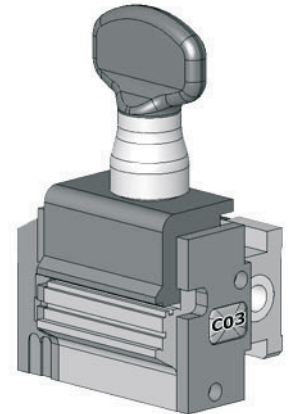

OPTIONAL

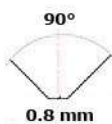

**RIC01781B**  
Fresino HB015  
Cutter HB015  
Fräser HB015  
Fraise HB015  
Fresa HB015



**RIC01782B**  
Tastatore B015  
Tracer Point B015  
Taster B015  
Palpeur B015  
Palpador B015

STANDARD

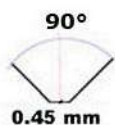

**RIC01793B**  
Fresino HB020  
Cutter HB020  
Fräser HB020  
Fraise HB020  
Fresa HB020



**RIC01794B**  
Tastatore B020  
Tracer Point B020  
Taster B020  
Palpeur B020  
Palpador B020



**303/304/305**







**T-REX  
T-REX ADVANCE**

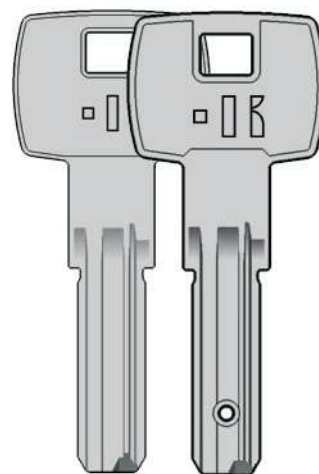

**PUNTO**

**IX 5  
IX5 KG**



   
DO120 DO100  
   
DO24 DO100X

prof. 048,069,100,102

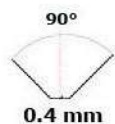

**RIC05044B**  
Fresino V001  
Cutter V001  
Fräser V001  
Fraise V001  
Fresa V001  
**STANDARD**

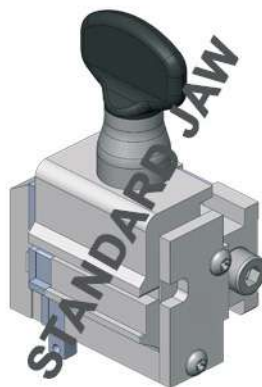

**NINJA TOTAL**



**NINJA VORTEX**



**VERSA**

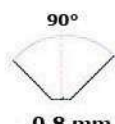

**RIC06104B**  
Fresino V021  
Cutter V021  
Fräser V021  
Fraise V021  
Fresa V021  
**OPTIONAL**

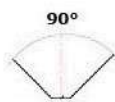

**RIC06368B**  
Fresino V022  
Cutter V022  
Fräser V022  
Fraise V022  
Fresa V022  
**OPTIONAL**





TO FIT: DOM (D)

**SIGMA  
SIGMA Plus**

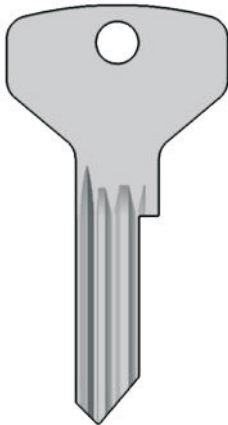

**WOL** (145)



**NINJA TOTAL**



**NINJA VORTEX**



**VERSA**

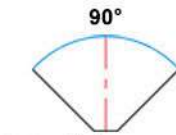

0.4 mm



**RIC05044B**  
Fresino V001  
Cutter V001  
Fräser V001  
Fraise V001  
Fresa V001  
STANDARD

OR

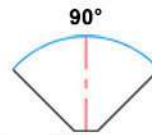

0.7 mm



**RIC05618B**  
Fresino V013  
Cutter V013  
Fräser V013  
Fraise V013  
Fresa V013  
OPTIONAL

FOR EDGE CUT

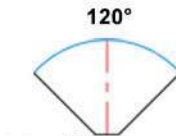

0.3 mm



**RIC05272B**  
Fresino V011  
Cutter V011  
Fräser V011  
Fraise V011  
Fresa V011  
OPTIONAL

OR

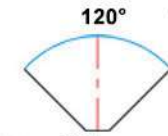

0.8 mm



**RIC07726B**  
Fresino V034  
Cutter V034  
Fräser V034  
Fraise V034  
Fresa V034  
OPTIONAL

FOR DIMPLE CUT

**OPZ07204B**  
Morsetto C12  
Jaw C12  
Spannbacke C12  
Étau C12  
Mordaza C12  
OPTIONAL



TO FIT: DOM (D)

**IX 6  
IX 6KG 3A**



(121)  
(102)  
(093)



**303/304/305**



**T-REX  
T-REX ADVANCE**



**PUNTO**

OPTIONAL

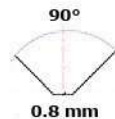

0.8 mm

**RIC01781B**  
Fresino HB015  
Cutter HB015  
Fräser HB015  
Fraise HB015  
Fresa HB015



**RIC01782B**  
Tastatore B015  
Tracer Point B015  
Taster B015  
Palpeur B015  
Palpador B015



**OPZ03712B**  
Adattatori per chiavi DOM  
Adaptors for DOM keys  
Adapters für DOM Schlüssel  
Adaptateurs pour clés DOM  
Adaptadores para llaves DOM

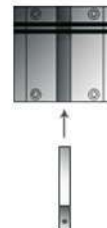

TO  
FIT :

DOM (D)

**OPTIONAL**



90°  
0.8 mm

**RIC06104B**  
Fresino V021  
Cutter V021  
Fräser V021  
Fraise V021  
Fresa V021



**OPZ05611B**  
Morsetto C02  
Jaw C02  
Spannbacke C02  
Étau C02  
Mordaza C02

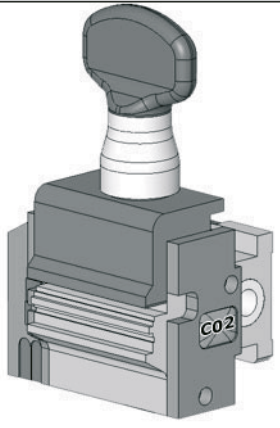

**NINJA TOTAL**





**NINJA VORTEX**



**VERSA**

IX 6  
IX 6KG 3A





(121)  
(102)  
(093)

TO  
FIT :

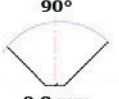

DOM (D)

**OPTIONAL**



90°  
0.8 mm

**RIC01781B**  
Fresino HB015  
Cutter HB015  
Fräser HB015  
Fraise HB015  
Fresa HB015



**RIC01782B**  
Tastatore B015  
Tracer Point B015  
Taster B015  
Palpeur B015  
Palpador B015

**STANDARD**

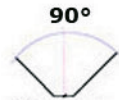

90°  
0.45 mm

**RIC01793B**  
Fresino HB020  
Cutter HB020  
Fräser HB020  
Fraise HB020  
Fresa HB020

**RIC01794B**  
Tastatore B020  
Tracer Point B020  
Taster B020  
Palpeur B020  
Palpador B020



**303/304/305**



**T-REX  
T-REX ADVANCE**



**PUNTO**



IX10

TO FIT: DOM (D)



IX10



**NINJA TOTAL**



**NINJA VORTEX**



**VERSA**

**STANDARD**

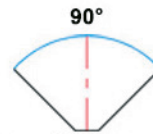

0.4 mm

**RIC05044B**  
Fresino V001  
Cutter V001  
Fräser V001  
Fraise V001  
Fresa V001

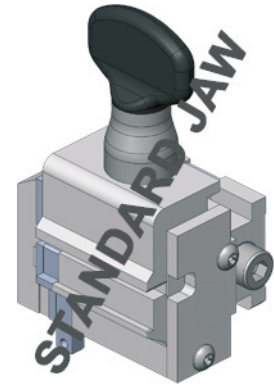

TO FIT: DOM (D)

**IXGAMMA**

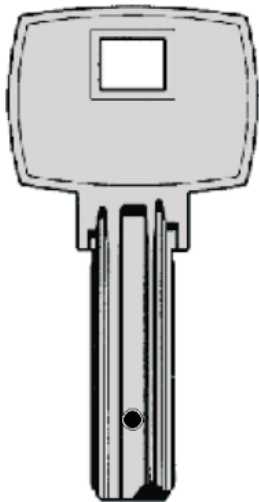

prof. 153, 154, 155  
WN 6454



**NINJA VORTEX**



**VERSA**

**OPTIONAL**



0.8 mm

**RIC06104B**  
Fresino V021  
Cutter V021  
Fräser V021  
Fraise V021  
Fresa V021



**OPZ07800B**  
Morsetto C15  
Jaw C15  
Spannbacke C15  
Étau C15  
Mordaza C15

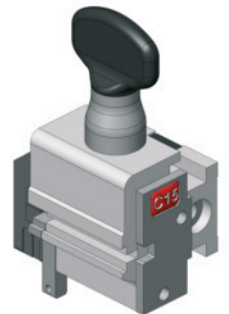

TO  
FIT :

DOM (D)

OPTIONAL



**RIC06104B**  
Fresino V021  
Cutter V021  
Fräser V021  
Fraise V021  
Fresa V021

**OPZ10401B**  
Morsetto C36  
Jaw C36  
Spannbacke C36  
Étau C36  
Mordaza C36



**NINJA TOTAL**



**NINJA VORTEX**



**VERSA**

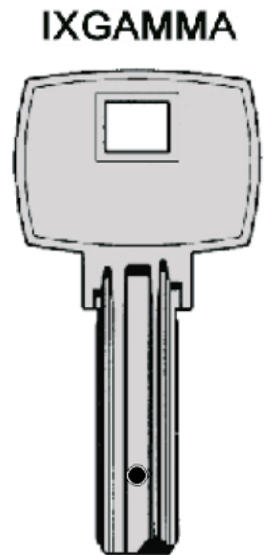

prof. 153, 154, 155  
WN 6454



TO  
FIT :

DOM (D)

OPTIONAL



**RIC05266B**  
Fresino V008  
Cutter V008  
Fräser V008  
Fraise V008  
Fresa V008

**OPZ06039B**  
Morsetto C08  
Jaw C08  
Spannbacke C08  
Étau C08  
Mordaza C08

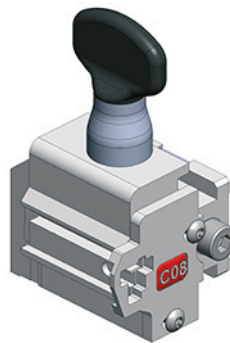

**NINJA VORTEX**



**VERSA**

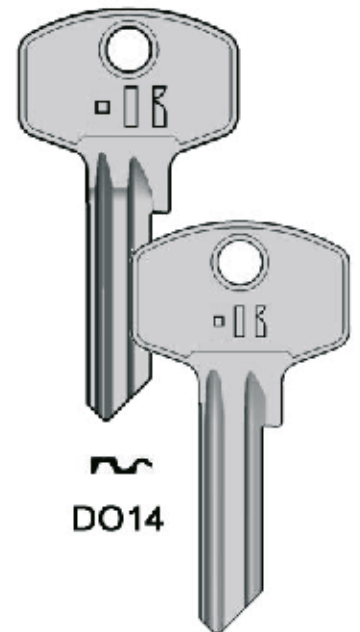

DO14

DO220



TO FIT: **DOM (D)**

**IX SAT**

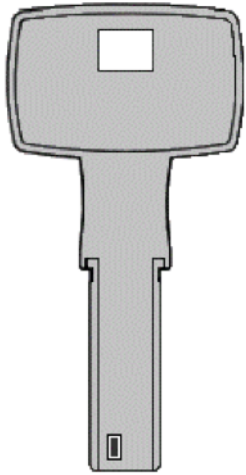

prof. 169,170,171,172



**NINJA TOTAL**



**NINJA VORTEX**



**VERSA**

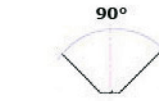

**0.8 mm**  
**RIC06104B**  
*Fresino V021*  
*Cutter V021*  
*Fräser V021*  
*Fraise V021*  
*Fresa V021*  
**OPTIONAL**

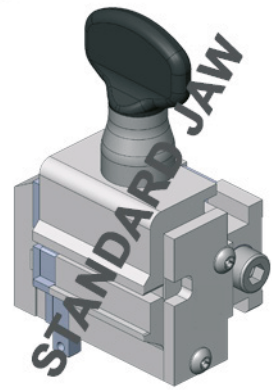

TO FIT: **DOMUS (GR)**

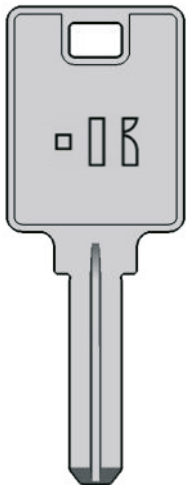

**DS1**



**303/304/305**



**T-REX**  
**T-REX ADVANCE**



**PUNTO**

**STANDARD**

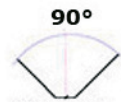

**0.45 mm**  
**RIC01793B**  
*Fresino HB020*  
*Cutter HB020*  
*Fräser HB020*  
*Fraise HB020*  
*Fresa HB020*



**RIC01794B**  
*Tastatore B020*  
*Tracer Point B020*  
*Taster B020*  
*Palpeur B020*  
*Palpador B020*

TO  
FIT :

DOMUS (GR)

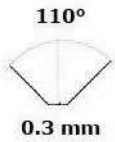

**RIC05270B**  
 Fresino V010  
 Cutter V010  
 Fräser V010  
 Fraise V010  
 Fresa V010  
**OPTIONAL**

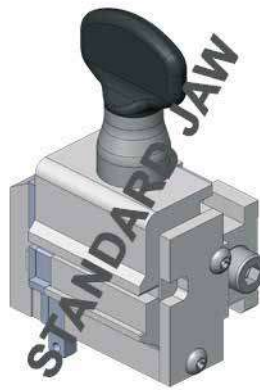

**NINJA TOTAL**



**NINJA VORTEX**



**VERSA**

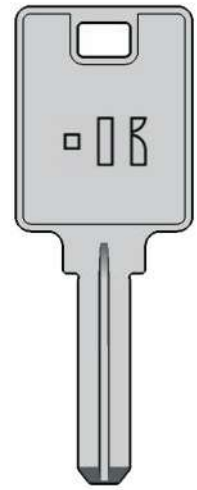

**DS1**

TO  
FIT :

ELZETT (H)

**OPTIONAL**

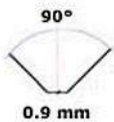

**RIC01775B**  
 Fresino HB005  
 Cutter HB005  
 Fräser HB005  
 Fraise HB005  
 Fresa HB005



**RIC01776B**  
 Tastatore B005  
 Tracer Point B005  
 Taster B005  
 Palpeur B005  
 Palpador B005



**303/304/305**



**T-REX  
T-REX ADVANCE**



**PUNTO**



**ELZETT**

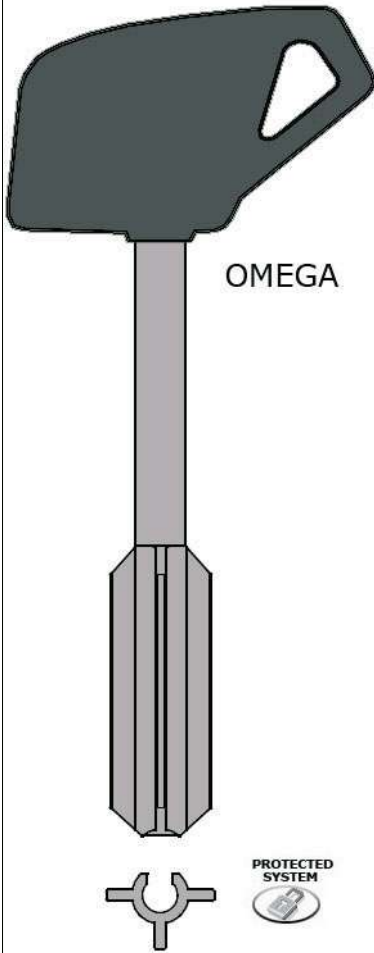

OMEGA



**NINJA VORTEX**



**VERSA**



**DEZMO**



**NINJA LASER**



**NINJA TOTAL**



**NINJA NINJA DARK**

**OPTIONAL**

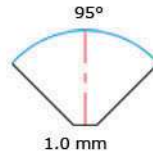

**RIC08161B**  
 Fresino V039  
 Cutter V039  
 Fräser V039  
 Fraise V039  
 Fresa V039

**OPZ08107B**  
 Morsetto C16  
 Jaw C16  
 Spannbacke C16  
 Étau C16  
 Mordaza C16



**OPTIONAL**

**OPZ09456B**  
 Adattatore B14 per chiavi Esety  
 Adaptor B14 for Esety keys  
 Adapter B14 für Esety-Schlüssel  
 Adaptateur B14 pour clés Esety  
 Adaptador B14 para llaves Esety



OPTIONAL



2 mm

**RIC01816B**  
Fresino HC044  
Cutter HC044  
Fräser HC044  
Fraise HC044  
Fresa HC044



**RIC01817B**  
Tastatore C044  
Tracer Point C044  
Taster C044  
Palpeur C044  
Palpador C044



**303/304/305**



**T-REX  
T-REX ADVANCE**



**PUNTO**



**EU8**



2.3 mm



**RIC05506B**  
Fresino V016  
Cutter V016  
Fräser V016  
Fraise V016  
Fresa V016  
**OPTIONAL**

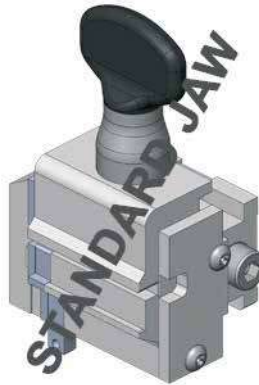

**NINJA TOTAL**



**NINJA VORTEX**



**VERSA**



ICS

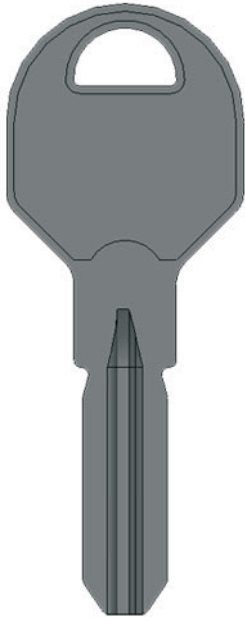

**303/304/305**

**T-REX  
T-REX ADVANCE**

**PUNTO**



**NINJA TOTAL**



**NINJA VORTEX**



**VERSA**

**OPTIONAL**



2 mm

**RIC01816B**  
Fresino HC044  
Cutter HC044  
Fräser HC044  
Fraise HC044  
Fresa HC044



**RIC01817B**  
Tastatore C044  
Tracer Point C044  
Taster C044  
Palpeur C044  
Palpador C044



2.00 mm

**RIC07786B**  
Fresino V037  
Cutter V037  
Fräser V037  
Fraise V037  
Fresa V037  
**OPTIONAL**

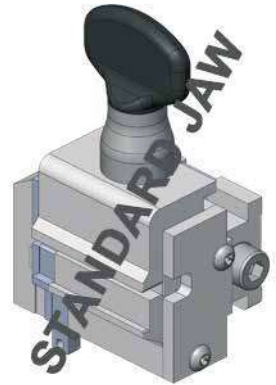

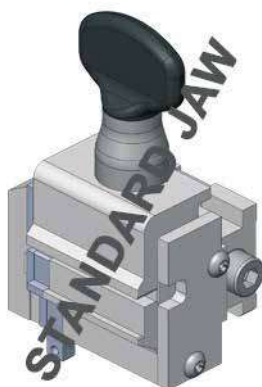

**NINJA TOTAL**



**NINJA VORTEX**



**VERSA**



**VERSA**

**3KS**  
**4KS**

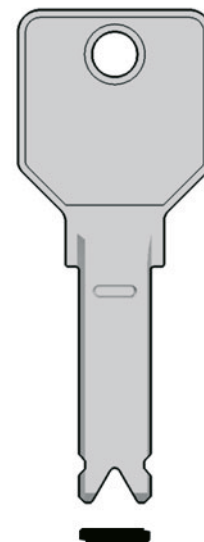

**OPTIONAL**

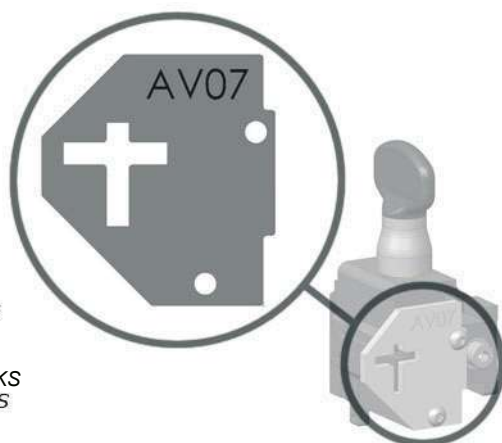

**OPZ08843B**  
Adattatore AV07 per EVVA 3KS  
Adaptor AV07 for EVVA 3KS  
Adapter AV07 für EVVA 3KS  
Adaptateur AV07 pour EVVA 3KS  
Adaptador AV07 para EVVA 3KS

DPI/DPS  
DPX/EPS



**NINJA VORTEX**



**VERSA**

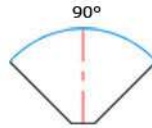

**0.40 mm**



**RIC05044B**  
Fresino V001  
Cutter V001  
Fräser V001  
Fraise V001  
Fresa V001  
**STANDARD**

**OR**

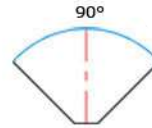

**0.70 mm**



**RIC05618B**  
Fresino V013  
Cutter V013  
Fräser V013  
Fraise V013  
Fresa V013  
**OPTIONAL**

**OPZ06039B**  
Morsetto C08  
Jaw C08  
Spannbacke C08  
Étau C08  
Mordaza C08  
**OPTIONAL**



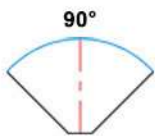

0.4 mm

**RIC05044B**  
Fresino V001  
Cutter V001  
Fräser V001  
Fraise V001  
Fresa V001

**STANDARD**



**OPZ06039B**  
Morsetto C08  
Jaw C08  
Spannbacke C08  
Étau C08  
Mordaza C08

**OPTIONAL**



**NINJA VORTEX**



**VERSA**

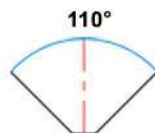

0.3 mm

**RIC05270B**  
Fresino V010  
Cutter V010  
Fräser V010  
Fraise V010  
Fresa V010

**OPTIONAL**

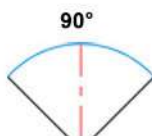

0.7 mm

**RIC05618B**  
Fresino V013  
Cutter V013  
Fräser V013  
Fraise V013  
Fresa V013

**OPTIONAL**



EV69-A  
EV10-A  
EV11-A  
EV5-A  
EV22S-A  
EV15-A  
EV13-A  
EV12-A



EV8S



EV10-FJ  
EV10-F  
EV5-F  
EV69-F



DS-15 2A

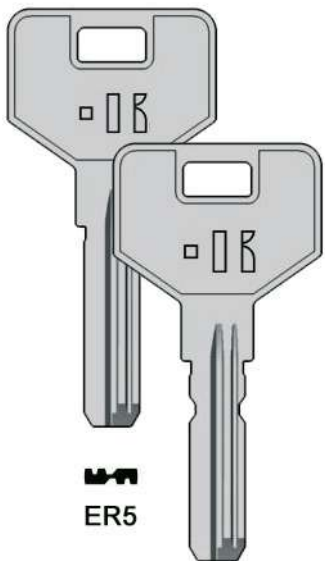

ER5

ER4



303/304/305



T-REX  
T-REX ADVANCE



PUNTO



NINJA TOTAL



NINJA VORTEX



VERSA

OPTIONAL

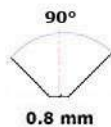

0.8 mm

**RIC01783B**  
Fresino HB026  
Cutter HB026  
Fräser HB026  
Fraise HB026  
Fresa HB026



**RIC01784B**  
Tastatore B026  
Tracer Point B026  
Taster B026  
Palpeur B026  
Palpador B026

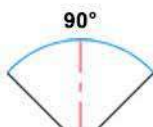

0.4 mm

**RIC05044B**  
Fresino V001  
Cutter V001  
Fräser V001  
Fraise V001  
Fresa V001  
**STANDARD**



OR

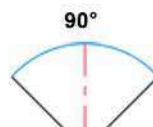

0.6 mm

**RIC05612B**  
Fresino V014  
Cutter V014  
Fräser V014  
Fraise V014  
Fresa V014  
**OPTIONAL**

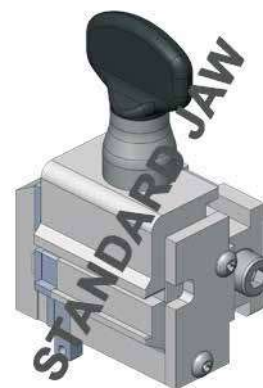

**OPTIONAL**

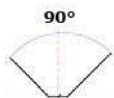

0.8 mm

**RIC01783B**  
Fresino HB026  
Cutter HB026  
Fräser HB026  
Fraise HB026  
Fresa HB026



**RIC01784B**  
Tastatore B026  
Tracer Point B026  
Taster B026  
Palpeur B026  
Palpador B026



**303/304/305**



**T-REX  
T-REX ADVANCE**



**PUNTO**

DS10  
DS15

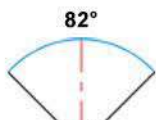
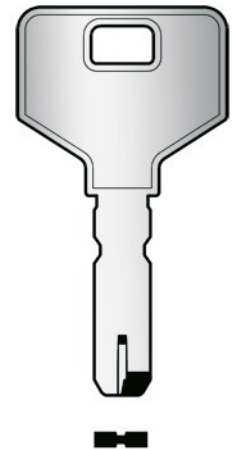

0.5 mm

**RIC05084B**  
Fresino V004  
Cutter V004  
Fräser V004  
Fraise V004  
Fresa V004  
**OPTIONAL**

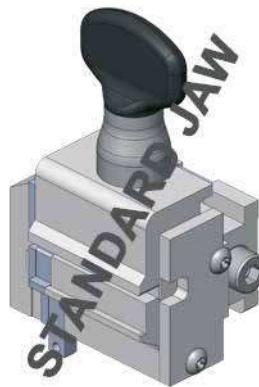

**NINJA TOTAL**



**NINJA VORTEX**



**VERSA**

FAB RS 200

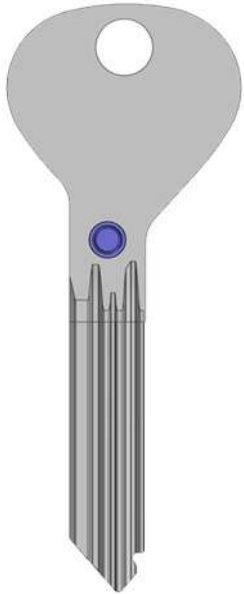

**DEZMO**

**OPTIONAL**

**OPZ09241B**

*Morsetto Z22 per chiavi Fab*  
*Jaw Z22 for Fab keys*  
*Spannbacke Z22 für Fab Schlüssel*  
*Étau Z22 pour clés Fab*  
*Mordaza Z22 para llaves Fab*

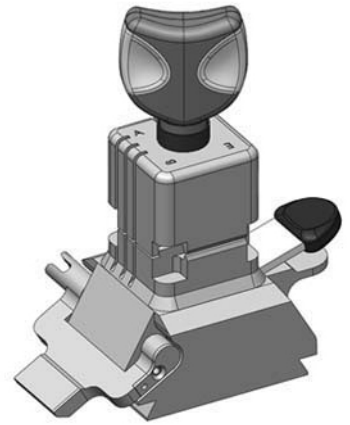

**DROMO**

**OPTIONAL**

**OPZ09427B**

*Kit adattatore Dromo per Fab RS 200*  
*Dromo Adaptor Kit for Fab RS 200*  
*Dromo Adapter Kit für Fab RS 200 Schlüssel*  
*Kit adaptateur Dromo pour clés Fab RS 200*  
*Kit adaptador Dromo para llaves Fab RS 200*

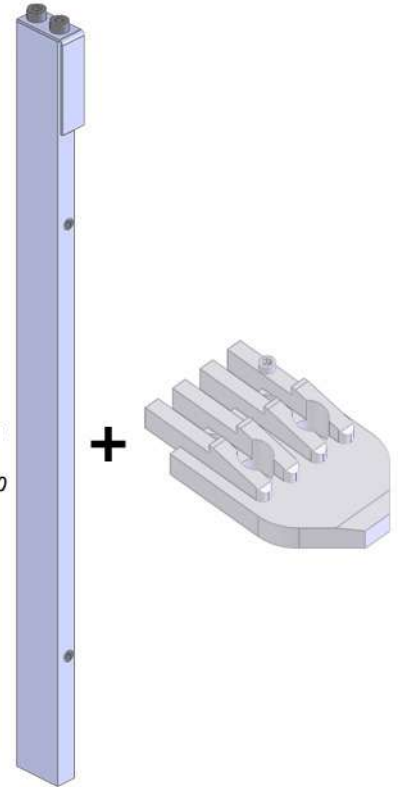

Per i Dromo con matricola inferiore a 17810009999, contattare Keyline.  
For Dromos with SN before 17810009999, please contact Keyline.  
Für Dromo mit Seriennummer unter Nummer 17810009999, setzen Sie sich mit Keyline in Verbindung.  
Pour le Dromo avec matricule inférieure à 17810009999, nous vous prions de contacter Keyline.  
Para los Dromo con matricula inferior a 17810009999, contactar Keyline.

**OPTIONAL**

**OPZ09330B**

*Morsetto N22 per chiavi Fab  
Jaw N22 for Fab keys  
Spannbacke N22 für Fab Schlüssel  
Étau N22 pour clés Fab  
Mordaza N22 para llaves Fab*



**NINJA LASER**



**NINJA TOTAL**



**NINJA  
NINJA DARK**

FAB RS 200

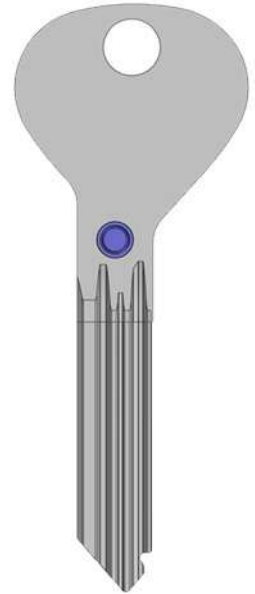



TO FIT: **FAB (CZ)**



**NINJA TOTAL**



**NINJA VORTEX**



**VERSA**

**OPTIONAL**

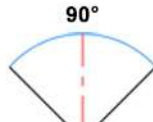

0.8 mm



**RIC06368B**  
*Fresino V022*  
*Cutter V022*  
*Fräser V022*  
*Fraise V022*  
*Fresa V022*

**OPZ10427B**

*Morsetto C39*  
*Jaw C39*  
*Spannbacke C39*  
*Étau C39*  
*Mordaza C39*



TO FIT: **FAC (E)**



**303/304/305**



**T-REX  
T-REX ADVANCE**



**PUNTO**

**STANDARD**

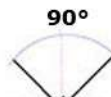

0.45 mm

**RIC01793B**  
*Fresino HB020*  
*Cutter HB020*  
*Fräser HB020*  
*Fraise HB020*  
*Fresa HB020*



**RIC01794B**  
*Tastatore B020*  
*Tracer Point B020*  
*Taster B020*  
*Palpeur B020*  
*Palpador B020*

TO  
FIT :

FAC (E)

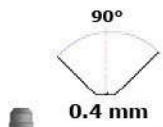

0.4 mm

**RIC05044B**  
*Fresino V001*  
*Cutter V001*  
*Fräser V001*  
*Fraise V001*  
*Fresa V001*  
**STANDARD**

OR

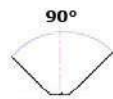

0.7 mm

**RIC05618B**  
*Fresino V013*  
*Cutter V013*  
*Fräser V013*  
*Fraise V013*  
*Fresa V013*  
**OPTIONAL**

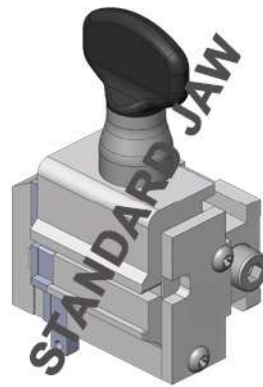

**NINJA TOTAL**



**NINJA VORTEX**



**VERSA**



TO  
FIT :

FAYN (TR)

**OPTIONAL**

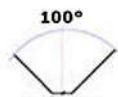

0.7 mm

**RIC01789B**  
*Fresino HB042*  
*Cutter HB042*  
*Fräser HB042*  
*Fraise HB042*  
*Fresa HB042*



HB042



B042

**RIC01790B**  
*Tastatore B042*  
*Tracer Point B042*  
*Taster B042*  
*Palpeur B042*  
*Palpador B042*



**303/304/305**



**T-REX  
T-REX ADVANCE**



**PUNTO**



TO FIT: **FAYN (TR)**



**NINJA TOTAL**



**NINJA VORTEX**



**VERSA**

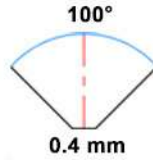

**RIC05264B**  
*Fresino V007*  
*Cutter V007*  
*Fräser V007*  
*Fraise V007*  
*Fresa V007*  
**OPTIONAL**

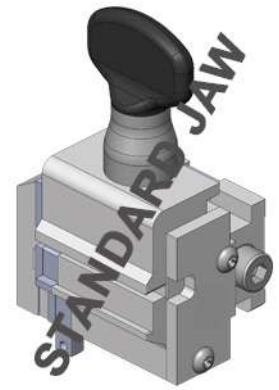

TO FIT: **FCV (D)**

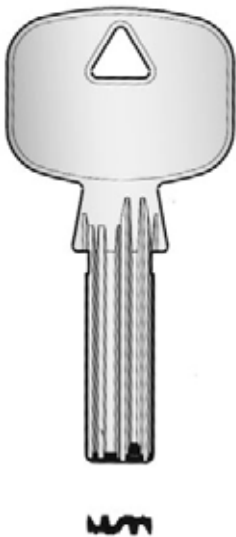

**303/304/305**



**T-REX  
T-REX ADVANCE**



**PUNTO**

**STANDARD**

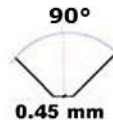

**RIC01793B**  
*Fresino HB020*  
*Cutter HB020*  
*Fräser HB020*  
*Fraise HB020*  
*Fresa HB020*



**RIC01794B**  
*Tastatore B020*  
*Tracer Point B020*  
*Taster B020*  
*Palpeur B020*  
*Palpador B020*

TO  
FIT :

FCV (D)

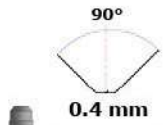

0.4 mm

**RIC05044B**  
Fresino V001  
Cutter V001  
Fräser V001  
Fraise V001  
Fresa V001  
**STANDARD**

OR

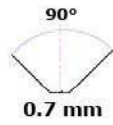

0.7 mm

**RIC05618B**  
Fresino V013  
Cutter V013  
Fräser V013  
Fraise V013  
Fresa V013  
**OPTIONAL**

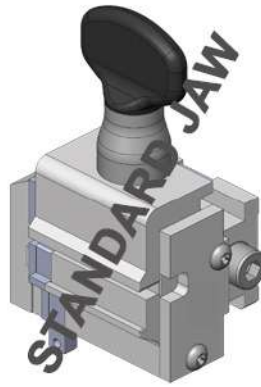

**NINJA TOTAL**



**NINJA VORTEX**



**VERSA**

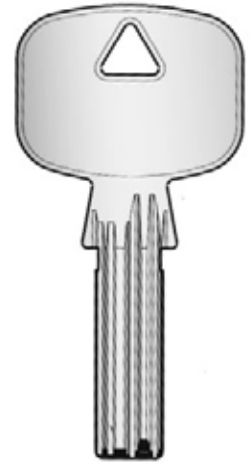

**W**

TO  
FIT :

FIAM (I)

**OPTIONAL**

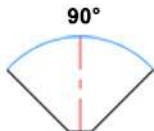

1,0 mm

**RIC01822B**  
Fresino HB043  
Cutter HB043  
Fräser HB043  
Fraise HB043  
Fresa HB043



**RIC01823B**  
Tastatore B043  
Tracer Point B043  
Taster B043  
Palpeur B043  
Palpador B043



**303/304/305**



**T-REX  
T-REX ADVANCE**



**PUNTO**

**LOGIC**

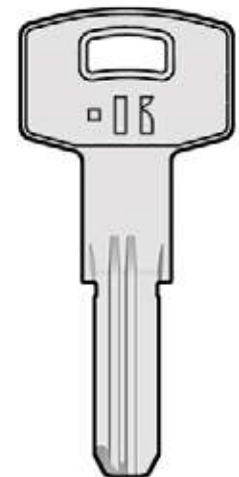

**FIA3S**



TO FIT: **FIAM (I)**

**LOGIC**

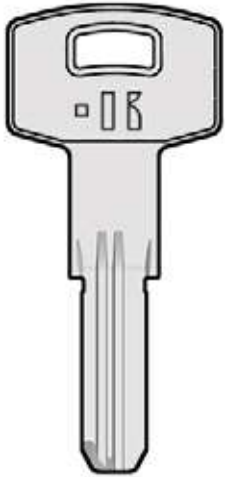

**FIA3S**



**NINJA TOTAL**



**NINJA VORTEX**



**VERSA**

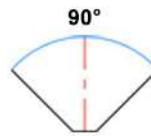

0.4 mm



**RIC05044B**  
*Fresino V001*  
*Cutter V001*  
*Fräser V001*  
*Fraise V001*  
*Fresa V001*  
**STANDARD**

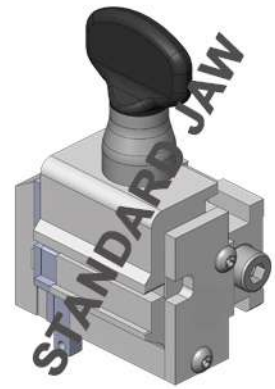

**OPZ10584B**  
*Adattatore AV11*  
*Adaptor AV11*  
*Adapter AV11*  
*Adaptateur AV11*  
*Adaptador AV11*  
**OPTIONAL**

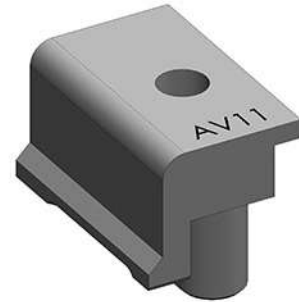

TO FIT: **FICHET (F)**

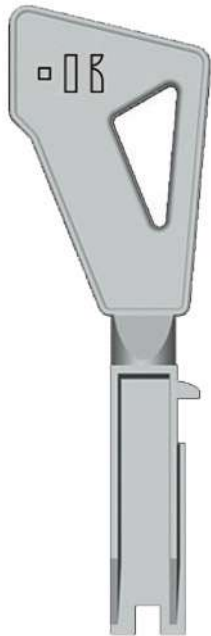

**FIC3**



**303/304/305**



**T-REX**  
**T-REX ADVANCE**

**OPTIONAL**



2.5 mm

**RIC01810B**  
*Fresino HC011*  
*Cutter HC011*  
*Fräser HC011*  
*Fraise HC011*  
*Fresa HC011*



**RIC01811B**  
*Tastatore C011*  
*Tracer Point C011*  
*Taster C011*  
*Palpeur C011*  
*Palpador C011*



**OPZ02653B**  
*Adattatori per chiavi Fichet*  
*Adaptors for Fichet keys*  
*Adapters für Fichet-Schlüssel*  
*Adaptateurs pour clés Fichet*  
*Adapadores para llaves Fichet*

**STANDARD**

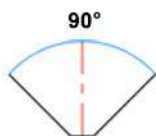

0.45 mm

**RIC01793B**

*Fresino HB020  
Cutter HB020  
Fräser HB020  
Fraise HB020  
Fresa HB020*



**RIC01794B**

*Tastatore B020  
Tracer Point B020  
Taster B020  
Palpeur B020  
Palpador B020*

**OPTIONAL**

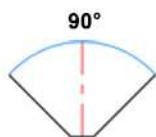

0.9 mm

**RIC01775B**

*Fresino HB005  
Cutter HB005  
Fräser HB005  
Fraise HB005  
Fresa HB005*



**RIC01776B**

*Tastatore B005  
Tracer Point B005  
Taster B005  
Palpeur B005  
Palpador B005*



**303/304/305**



**T-REX  
T-REX ADVANCE**



**PUNTO**

**ATLANTIC  
TRANSIT**

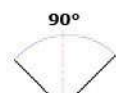
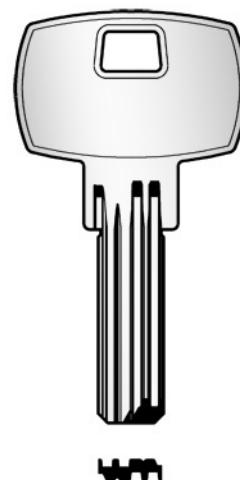

0.4 mm



**RIC05044B**  
*Fresino V001  
Cutter V001  
Fräser V001  
Fraise V001  
Fresa V001*

**STANDARD**

OR

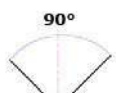

0.6 mm



**RIC05612B**  
*Fresino V014  
Cutter V014  
Fräser V014  
Fraise V014  
Fresa V014*

**OPTIONAL**

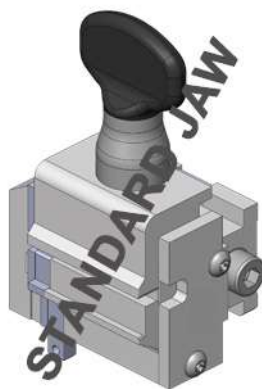

**NINJA TOTAL**



**NINJA VORTEX**



**VERSA**

TO FIT: **GE-GE (A)**

**7p Extra SE**



**NINJA VORTEX**



**VERSA**

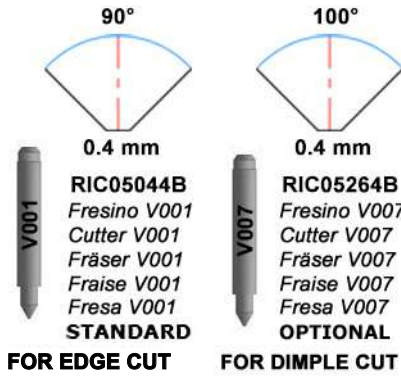

**OPZ06039B**  
Morsetto C08  
Jaw C08  
Spannbacke C08  
Étau C08  
Mordaza C08  
**OPTIONAL**



TO FIT: **GERA (D)**

WS  
WS X  
WS XP



WSG PLUS  
WSG X  
WSG XP



**NINJA TOTAL**



**NINJA VORTEX**



**VERSA**

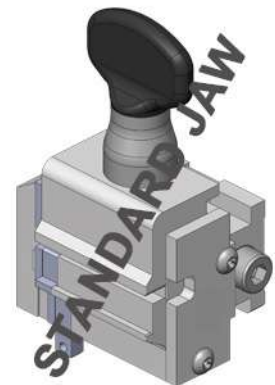

TO  
FIT :

GIUSSANI (I)

**OPTIONAL**



1.5 mm

**RIC01820B**  
*Fresino HC003*  
*Cutter HC003*  
*Fräser HC003*  
*Fraise HC003*  
*Fresa HC003*



**RIC01821B**  
*Tastatore C003*  
*Tracer Point C003*  
*Taster C003*  
*Palpeur C003*  
*Palpador C003*



**303/304/305**



**T-REX  
T-REX ADVANCE**



**PUNTO**



**GIS17**

TO  
FIT :

GOAL (J)

**STANDARD**

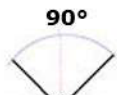

0.45 mm

**RIC01793B**  
*Fresino HB020*  
*Cutter HB020*  
*Fräser HB020*  
*Fraise HB020*  
*Fresa HB020*



**RIC01794B**  
*Tastatore B020*  
*Tracer Point B020*  
*Taster B020*  
*Palpeur B020*  
*Palpador B020*



**303/304/305**



**T-REX  
T-REX ADVANCE**



**PUNTO**

V18  
V9



**KL109**



TO FIT: **GOAL (J)**

V18  
V9



KL109



**NINJA TOTAL**



**NINJA VORTEX**



**VERSA**

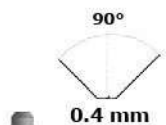

0.4 mm

**RIC05044B**  
Fresino V001  
Cutter V001  
Fräser V001  
Fraise V001  
Fresa V001

**STANDARD**

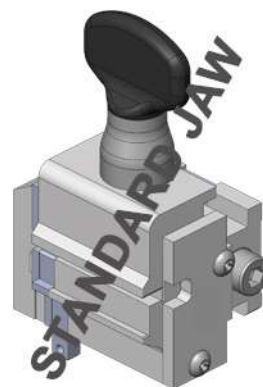

OR

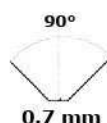

0.7 mm

**RIC05618B**  
Fresino V013  
Cutter V013  
Fräser V013  
Fraise V013  
Fresa V013

**OPTIONAL**



OR

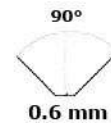

0.6 mm

**RIC05612B**  
Fresino V014  
Cutter V014  
Fräser V014  
Fraise V014  
Fresa V014

**OPTIONAL**



TO FIT: **ICSA (I)**



IC1



**303/304/305**



**T-REX  
T-REX ADVANCE**



**PUNTO**

**STANDARD**

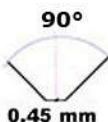

0.45 mm

**RIC01793B**  
Fresino HB020  
Cutter HB020  
Fräser HB020  
Fraise HB020  
Fresa HB020



**RIC01794B**  
Tastatore B020  
Tracer Point B020  
Taster B020  
Palpeur B020  
Palpador B020

**OPTIONAL**

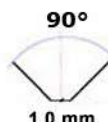

1.0 mm

**RIC01822B**  
Fresino HB043  
Cutter HB043  
Fräser HB043  
Fraise HB043  
Fresa HB043



**RIC01823B**  
Tastatore B043  
Tracer Point B043  
Taster B043  
Palpeur B043  
Palpador B043

TO  
FIT :

ICSA (I)

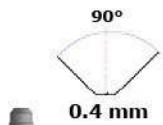

0.4 mm

**RIC05044B**  
*Fresino V001*  
*Cutter V001*  
*Fräser V001*  
*Fraise V001*  
*Fresa V001*  
**STANDARD**

OR

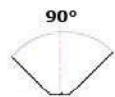

0.7 mm

**RIC05618B**  
*Fresino V013*  
*Cutter V013*  
*Fräser V013*  
*Fraise V013*  
*Fresa V013*  
**OPTIONAL**

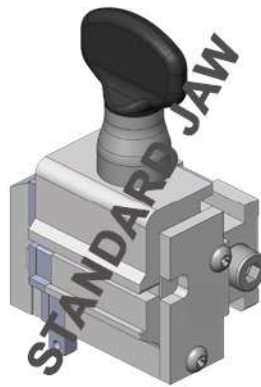

**NINJA TOTAL**



**NINJA VORTEX**



**VERSA**

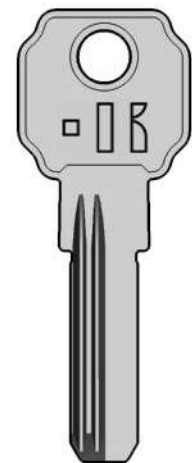

**IC1**

TO  
FIT :

IFAM (E)

**STANDARD**



0.45 mm

**RIC01793B**  
*Fresino HB020*  
*Cutter HB020*  
*Fräser HB020*  
*Fraise HB020*  
*Fresa HB020*



**RIC01794B**  
*Tastatore B020*  
*Tracer Point B020*  
*Taster B020*  
*Palpeur B020*  
*Palpador B020*



**303/304/305**



**T-REX  
T-REX ADVANCE**



**PUNTO**



TO FIT: **IFAM (E)**



**NINJA TOTAL**



**NINJA VORTEX**



**VERSA**

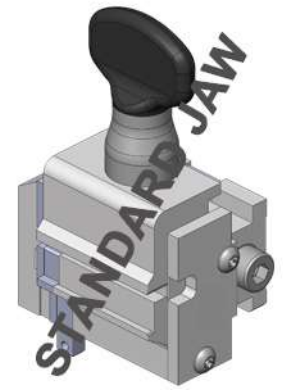
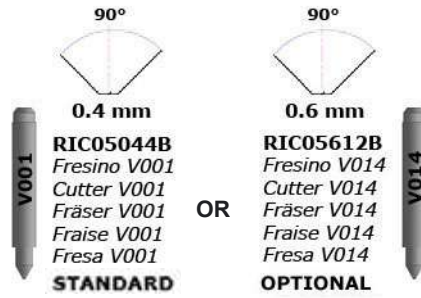

TO FIT: **INAHO (J)**

6+7P



**NINJA TOTAL**



**NINJA VORTEX**



**VERSA**



**OPZ07800B**  
Morsetto C15  
Jaw C15  
Spannbacke C15  
Étau C15  
Mordaza C15  
**OPTIONAL**



**OPTIONAL**

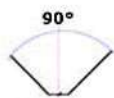

0.6 mm

**RIC01785B**  
Fresino HB039  
Cutter HB039  
Fräser HB039  
Fraise HB039  
Fresa HB039



**RIC01786B**  
Tastatore B039  
Tracer Point B039  
Taster B039  
Palpeur B039  
Palpador B039



**303/304/305**



**T-REX  
T-REX ADVANCE**



**PUNTO**

**ISR100WEB**



4.0 mm

**RIC05044B**  
Fresino V001  
Cutter V001  
Fräser V001  
Fraise V001  
Fresa V001  
**STANDARD**



**OPZ05701B**  
Morsetto C03  
Jaw C03  
Spannbacke C03  
Étau C03  
Mordaza C03  
**OPTIONAL**



**NINJA TOTAL**



**NINJA VORTEX**



**VERSA**



R6  
R7

R11  
R50

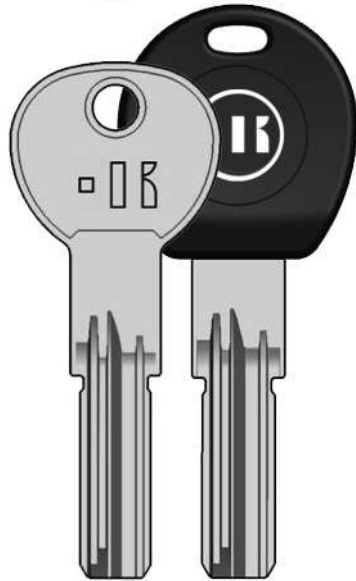

ISE14  
ISE15  
ISE17



ISE14P  
ISE15P  
ISE17P



**303/304/305**



**T-REX  
T-REX ADVANCE**



**PUNTO**

**STANDARD**

90°



0.45 mm

**RIC01793B**

*Fresino HB020  
Cutter HB020  
Fräser HB020  
Fraise HB020  
Fresa HB020*



**RIC01794B**

*Tastatore B020  
Tracer Point B020  
Taster B020  
Palpeur B020  
Palpador B020*

**OPTIONAL**

90°



0.6 mm

**RIC01785B**

*Fresino HB039  
Cutter HB039  
Fräser HB039  
Fraise HB039  
Fresa HB039*



**RIC01786B**

*Tastatore B039  
Tracer Point B039  
Taster B039  
Palpeur B039  
Palpador B039*



**NINJA TOTAL**



**NINJA VORTEX**



**VERSA**

90°



0.4 mm



**RIC05044B**

*Fresino V001  
Cutter V001  
Fräser V001  
Fraise V001  
Fresa V001*

**STANDARD**

90°

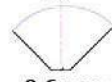

0.6 mm



**RIC05612B**

*Fresino V014  
Cutter V014  
Fräser V014  
Fraise V014  
Fresa V014*

**OPTIONAL**

OR

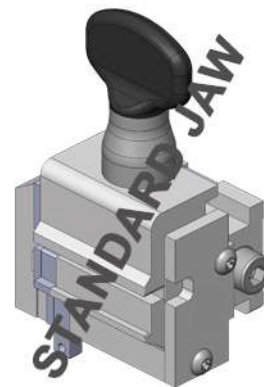

TO  
FIT :

ISEO (I)

OPTIONAL

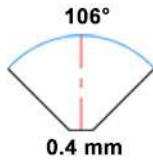

**RIC05266B**  
Fresino V008  
Cutter V008  
Fräser V008  
Fraise V008  
Fresa V008

**OPZ06039B**  
Morsetto C08  
Jaw C08  
Spannbacke C08  
Étau C08  
Mordaza C08



**NINJA VORTEX**



**VERSA**



5 pin  
ISE5D  
ISE5S  
ISE5SM  
ISE51  
ISE31  
ISE2

4 pin  
ISE41D  
ISE41S  
ISE4D  
ISE4S

3 pin  
ISE3D  
ISE3S

TO  
FIT :

ITO (TR)

OPTIONAL

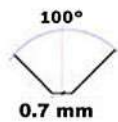

**RIC01789B**  
Fresino HB042  
Cutter HB042  
Fräser HB042  
Fraise HB042  
Fresa HB042



**RIC01790B**  
Tastatore B042  
Tracer Point B042  
Taster B042  
Palpeur B042  
Palpador B042



**303/304/305**



**T-REX  
T-REX ADVANCE**



**PUNTO**

I01

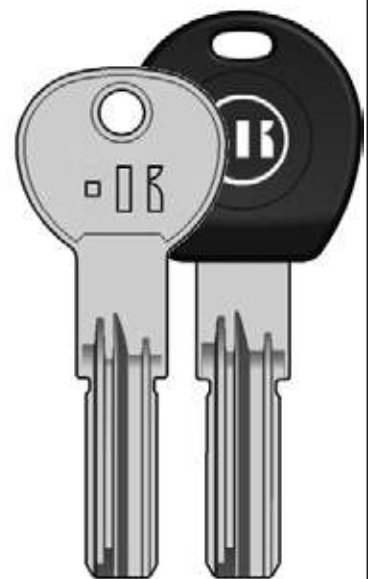

ISE17 ISE17P

TO FIT: ITO (TR)

I01



HNH

HNH

ISE17

ISE17P



**NINJA TOTAL**



**NINJA VORTEX**



**VERSA**

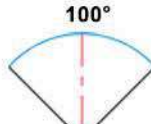

0.4 mm



**RIC05264B**  
 Fresino V007  
 Cutter V007  
 Fräser V007  
 Fraise V007  
 Fresa V007  
**OPTIONAL**

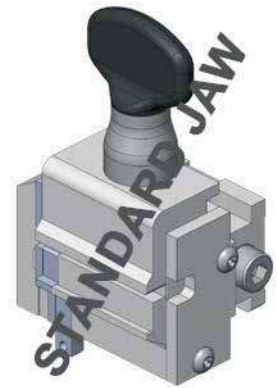

TO FIT: JIS (E)

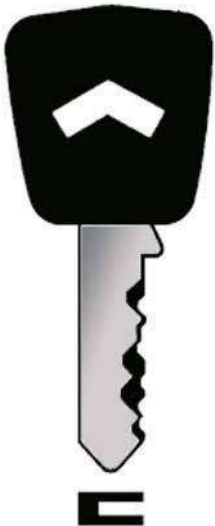

**303/304/305**



**T-REX  
 T-REX ADVANCE**



**PUNTO**

**MJ**  
 Adattatori per chiavi Jis  
 Adaptors for Jis keys  
 Adapter für Jis-Schlüssel  
 Adaptateurs pour clés Jis  
 Adaptadores para llaves Jis  
**OPTIONAL**



2.5 mm

**RIC01810B**  
 Fresino HC011  
 Cutter HC011  
 Fräser HC011  
 Fraise HC011  
 Fresa HC011  
**STANDARD**



**RIC01811B**  
 Tastatore C011  
 Tracer Point C011  
 Taster C011  
 Palpeur C011  
 Palpador C011  
**STANDARD**

**OPTIONAL**



**MK45**  
Adattatori per chiavi Kaba 45°  
Adaptors for Kaba 45° keys  
Adapters für Kaba 45°-Schlüssel  
Adaptateurs pour clés Kaba 45°  
Adaptadores para llaves Kaba 45°

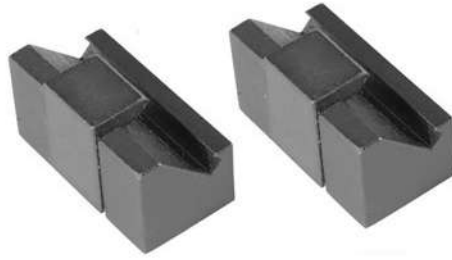

**T-REX**

**KABA 20**

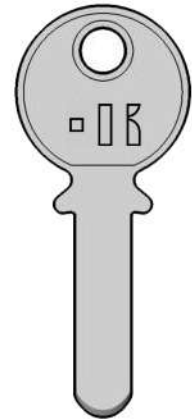

**STANDARD**



90°

0.45 mm

**RIC01793B**  
Fresino HB020  
Cutter HB020  
Fräser HB020  
Fraise HB020  
Fresa HB020



**RIC01794B**  
Tastatore B020  
Tracer Point B020  
Taster B020  
Palpeur B020  
Palpador B020

**OPTIONAL**



90°

0.7 mm

**RIC01791B**  
Fresino HB001  
Cutter HB001  
Fräser HB001  
Fraise HB001  
Fresa HB001



**RIC01792B**  
Tastatore B001  
Tracer Point B001  
Taster B001  
Palpeur B001  
Palpador B001



**303**



**PUNTO**

**KA2**

**OPTIONAL**



90°

1.0 mm

**RIC01822B**  
Fresino HB043  
Cutter HB043  
Fräser HB043  
Fraise HB043  
Fresa HB043



**RIC01823B**  
Tastatore B043  
Tracer Point B043  
Taster B043  
Palpeur B043  
Palpador B043

**STANDARD**



90°

0.45 mm

**RIC01793B**  
Fresino HB020  
Cutter HB020  
Fräser HB020  
Fraise HB020  
Fresa HB020



**RIC01794B**  
Tastatore B020  
Tracer Point B020  
Taster B020  
Palpeur B020  
Palpador B020

**OPTIONAL**



90°

0.7 mm

**RIC01791B**  
Fresino HB001  
Cutter HB001  
Fräser HB001  
Fraise HB001  
Fresa HB001



**RIC01792B**  
Tastatore B001  
Tracer Point B001  
Taster B001  
Palpeur B001  
Palpador B001



**T-REX ADVANCE**



**304/305**

**OPTIONAL**



90°

1.0 mm

**RIC01822B**  
Fresino HB043  
Cutter HB043  
Fräser HB043  
Fraise HB043  
Fresa HB043



**RIC01823B**  
Tastatore B043  
Tracer Point B043  
Taster B043  
Palpeur B043  
Palpador B043



**KABA 20**



**KA2**



**NINJA TOTAL**



**NINJA VORTEX**



**VERSA**

**OPTIONAL**

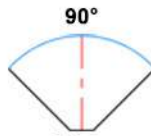

**0.8 mm**

**RIC06368B**

- Fresino V022*
- Cutter V022*
- Fräser V022*
- Fraise V022*
- Fresa V022*



**OPZ08506B**

- Morsetto C22*
- Jaw C22*
- Spannbacke C22*
- Étau C22*
- Mordaza C22*

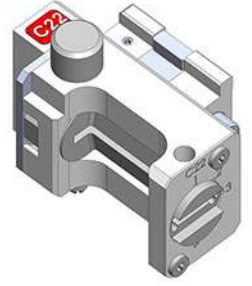

**INCLUDED WITH JAW**

- Tastatore T005*
- Tracer Point T005*
- Taster T005*
- Palpeur T005*
- Palpador T005*



**OPTIONAL**

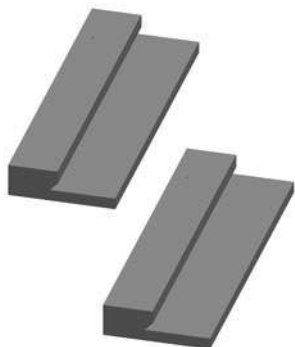

**OPZ06644B**  
*Adattatori per Kaba Micro e KYR*  
*Adaptors for Kaba Micro and KYR*  
*Adapters für Kaba Micro und KYR*  
*Adaptateurs pour Kaba Micro et KYR*  
*Adaptadores para Kaba Micro y KYR*



**303/304/305**



**T-REX  
T-REX ADVANCE**

KABA MICRO



KA8

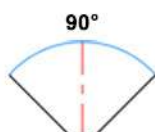

0.4 mm



**RIC05044B**  
*Fresino V001*  
*Cutter V001*  
*Fräser V001*  
*Fraise V001*  
*Fresa V001*  
**STANDARD**

**OPZ07800B**  
*Morsetto C15*  
*Jaw C15*  
*Spannbacke C15*  
*Étau C15*  
*Mordaza C15*  
**OPTIONAL**



**NINJA TOTAL**



**NINJA VORTEX**



**VERSA**

**KABA 8**



**KA1**



**303/304/305**



**T-REX  
T-REX ADVANCE**



**PUNTO**

**OPTIONAL**

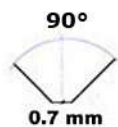

**RIC01791B**  
Fresino HB001  
Cutter HB001  
Fräser HB001  
Fraise HB001  
Fresa HB001



**RIC01792B**  
Tastatore B001  
Tracer Point B001  
Taster B001  
Palpeur B001  
Palpador B001

**STANDARD**

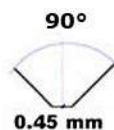

**RIC01793B**  
Fresino HB020  
Cutter HB020  
Fräser HB020  
Fraise HB020  
Fresa HB020



**RIC01794B**  
Tastatore B020  
Tracer Point B020  
Taster B020  
Palpeur B020  
Palpador B020



**NINJA TOTAL**



**NINJA VORTEX**



**VERSA**

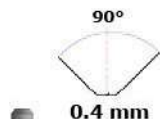

**RIC05044B**  
Fresino V001  
Cutter V001  
Fräser V001  
Fraise V001  
Fresa V001  
**STANDARD**



**OR**

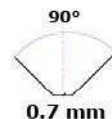

**RIC05618B**  
Fresino V013  
Cutter V013  
Fräser V013  
Fraise V013  
Fresa V013  
**OPTIONAL**

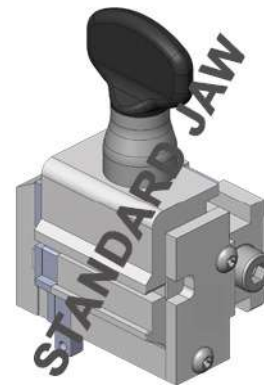

TO  
FIT :

KABA (CH)

OPTIONAL

**OPZ08505B**  
Morsetto C21  
Jaw C21  
Spannbacke C21  
Étau C21  
Mordaza C21

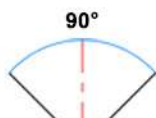
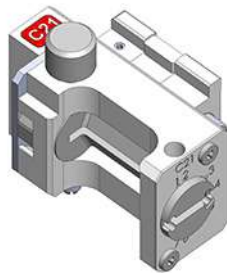

0.56 mm



**RIC06581B**  
Fresino V052  
Cutter V052  
Fräser V052  
Fraise V052  
Fresa V052



**INCLUDED WITH JAW**  
Tastatore T005  
Tracer Point T005  
Taster T005  
Palpeur T005  
Palpador T005



**NINJA TOTAL**



**NINJA VORTEX**



**VERSA**

EXPER T



TO  
FIT :

KABA (CH)

OPTIONAL

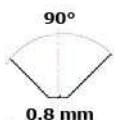

0.8 mm

**RIC01781B**  
Fresino HB015  
Cutter HB015  
Fräser HB015  
Fraise HB015  
Fresa HB015



**RIC01782B**  
Tastatore B015  
Tracer Point B015  
Taster B015  
Palpeur B015  
Palpador B015

**303/304/305**



**T-REX  
T-REX ADVANCE**



STANDARD

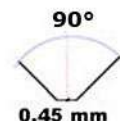

0.45 mm

**RIC01793B**  
Fresino HB020  
Cutter HB020  
Fräser HB020  
Fraise HB020  
Fresa HB020



**RIC01794B**  
Tastatore B020  
Tracer Point B020  
Taster B020  
Palpeur B020  
Palpador B020



**PUNTO**



MINI KABA



TO FIT: **KABA (CH)**



MINI KABA



**NINJA TOTAL**



**NINJA VORTEX**



**VERSA**

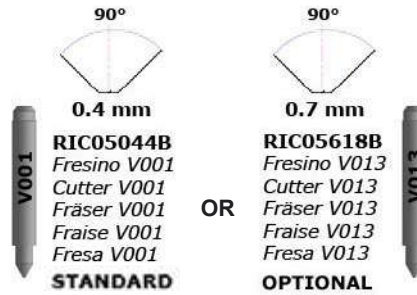

**RIC05044B**  
Fresino V001  
Cutter V001  
Fräser V001  
Fraise V001  
Fresa V001  
**STANDARD**

OR

**RIC05618B**  
Fresino V013  
Cutter V013  
Fräser V013  
Fraise V013  
Fresa V013  
**OPTIONAL**

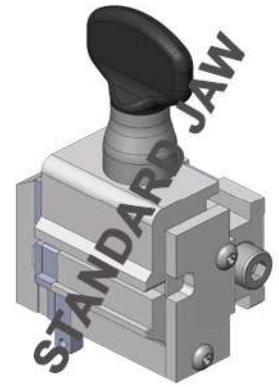

TO FIT: **KABA (CH)**

KABA GEMINI

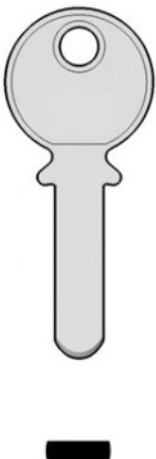

**T-REX**



**303**



**PUNTO**

**OPTIONAL**



**MK15**  
Adattatori per chiavi Kaba 15°  
Adaptors for Kaba 15° keys  
Adapters für Kaba 15°-Schlüssel  
Adaptateurs pour clés Kaba 15°  
Adaptadores para llaves Kaba 15°



**STANDARD**

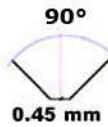

0.45 mm

**RIC01793B**  
Fresino HB020  
Cutter HB020  
Fräser HB020  
Fraise HB020  
Fresa HB020



**RIC01794B**  
Tastatore B020  
Tracer Point B020  
Taster B020  
Palpeur B020  
Palpador B020

**OPTIONAL**

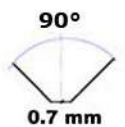

0.7 mm

**RIC01791B**  
Fresino HB001  
Cutter HB001  
Fräser HB001  
Fraise HB001  
Fresa HB001



**RIC01792B**  
Tastatore B001  
Tracer Point B001  
Taster B001  
Palpeur B001  
Palpador B001

**OPTIONAL**



**RIC01791B**  
Fresino HB001  
Cutter HB001  
Fräser HB001  
Fraise HB001  
Fresa HB001

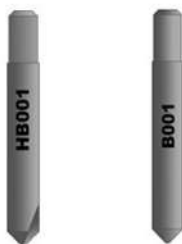

**RIC01792B**  
Tastatore B001  
Tracer Point B001  
Taster B001  
Palpeur B001  
Palpador B001

**STANDARD**



**RIC01793B**  
Fresino HB020  
Cutter HB020  
Fräser HB020  
Fraise HB020  
Fresa HB020



**RIC01794B**  
Tastatore B020  
Tracer Point B020  
Taster B020  
Palpeur B020  
Palpador B020



**T-REX ADVANCE**



**304/305**

**KABA GEMINI**

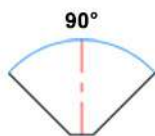

**RIC05044B**  
Fresino V001  
Cutter V001  
Fräser V001  
Fraise V001  
Fresa V001



**STANDARD**

**OPZ08505B**  
Morsetto C21  
Jaw C21  
Spannbacke C21  
Étau C21  
Mordaza C21

**OPTIONAL**

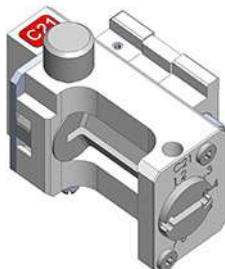

**NINJA TOTAL**



**NINJA VORTEX**



**VERSA**

maTrix

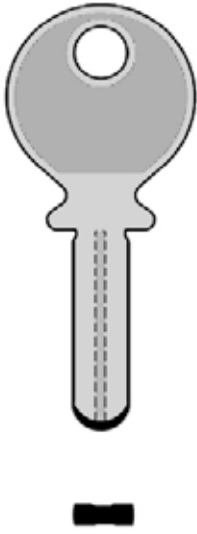

**NINJA TOTAL**



**NINJA VORTEX**



**VERSA**

OPTIONAL

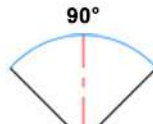

0.56 mm



**RIC06581B**  
Fresino V052  
Cutter V052  
Fräser V052  
Fraise V052  
Fresa V052



**INCLUDED WITH JAW**

Tastatore T005  
Tracer Point T005  
Taster T005  
Palpeur T005  
Palpador T005

**OPZ08505B**

Morsetto C21  
Jaw C21  
Spannbacke C21  
Étau C21  
Mordaza C21

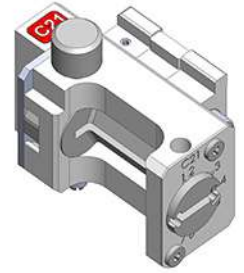

**304/305**



**T-REX  
T-REX ADVANCE**

OPTIONAL



0.7 mm



**RIC01792B**  
Tastatore B001  
Tracer Point B001  
Taster B001  
Palpeur B001  
Palpador B001



**RIC08487B**  
Fresino WB001  
Cutter WB001  
Fräser WB001  
Fraise WB001  
Fresa WB001

TO  
FIT :

KAKEN (J)

OPTIONAL



**OPZ07800B**  
Morsetto C15  
Jaw C15  
Spannbacke C15  
Étau C15  
Mordaza C15

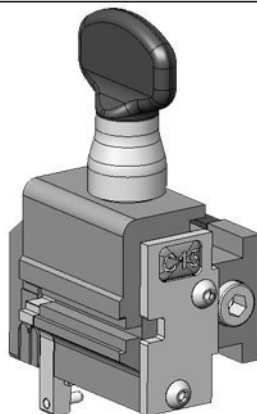

**NINJA TOTAL**



**NINJA VORTEX**



**VERSA**



TO  
FIT :

KALE (TR)

STANDARD

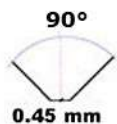

**RIC01793B**  
Fresino HB020  
Cutter HB020  
Fräser HB020  
Fraise HB020  
Fresa HB020



**RIC01794B**  
Tastatore B020  
Tracer Point B020  
Taster B020  
Palpeur B020  
Palpador B020



**303/304/305**



**T-REX  
T-REX ADVANCE**



**PUNTO**

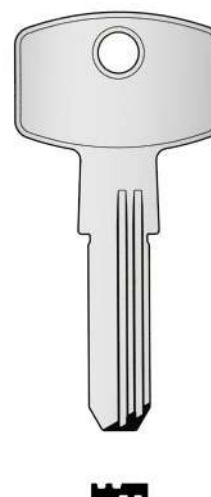



TO FIT: **KALE (TR)**

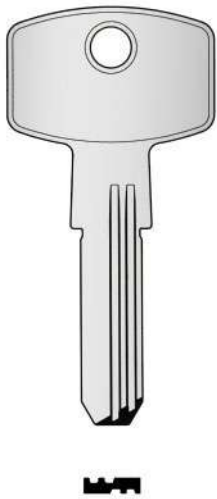

**NINJA TOTAL**



**NINJA VORTEX**



**VERSA**

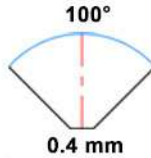

**RIC05264B**  
 Fresino V007  
 Cutter V007  
 Fräser V007  
 Fraise V007  
 Fresa V007  
**OPTIONAL**

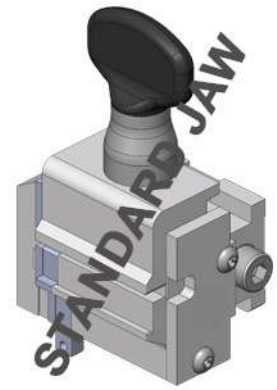

TO FIT: **KESO (CH)**

1000

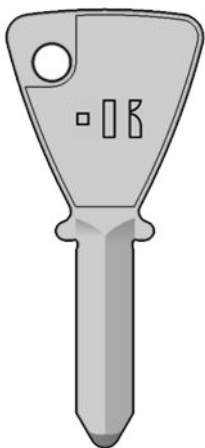

KS1



**T-REX**



**303**



**PUNTO**

**OPTIONAL**



**MK5**

Adattatori per chiavi Keso 5°  
 Adaptors for Keso 5° keys  
 Adapter für Keso 5°-Schlüssel  
 Adaptateurs pour clés Keso 5°  
 Adaptadores para llaves Keso 5°

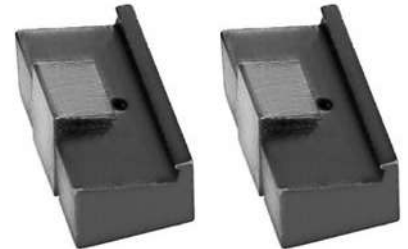

**STANDARD**



**RIC01793B**  
 Fresino HB020  
 Cutter HB020  
 Fräser HB020  
 Fraise HB020  
 Fresa HB020

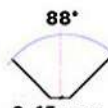

**RIC01794B**  
 Tastatore B020  
 Tracer Point B020  
 Taster B020  
 Palpeur B020  
 Palpador B020



**RIC01791B**  
 Fresino HB001  
 Cutter HB001  
 Fräser HB001  
 Fraise HB001  
 Fresa HB001

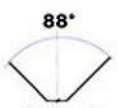

**RIC01792B**  
 Tastatore B001  
 Tracer Point B001  
 Taster B001  
 Palpeur B001  
 Palpador B001

**OPTIONAL**



**RIC01787B**  
 Fresino HB007  
 Cutter HB007  
 Fräser HB007  
 Fraise HB007  
 Fresa HB007



**RIC01788B**  
 Tastatore B007  
 Tracer Point B007  
 Taster B007  
 Palpeur B007  
 Palpador B007

**STANDARD**



**RIC01793B**  
Fresino HB020  
Cutter HB020  
Fräser HB020  
Fraise HB020  
Fresa HB020

**RIC01794B**  
Tastatore B020  
Tracer Point B020  
Taster B020  
Palpeur B020  
Palpador B020

**OPTIONAL**

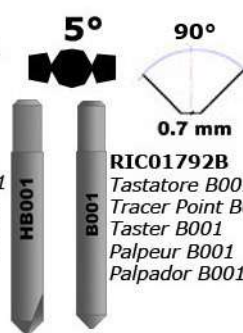

**RIC01791B**  
Fresino HB001  
Cutter HB001  
Fräser HB001  
Fraise HB001  
Fresa HB001

**RIC01792B**  
Tastatore B001  
Tracer Point B001  
Taster B001  
Palpeur B001  
Palpador B001

**OPTIONAL**

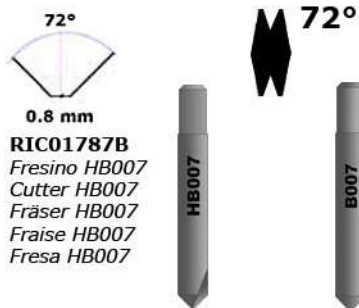

**RIC01787B**  
Fresino HB007  
Cutter HB007  
Fräser HB007  
Fraise HB007  
Fresa HB007

**RIC01788B**  
Tastatore B007  
Tracer Point B007  
Taster B007  
Palpeur B007  
Palpador B007



**T-REX ADVANCE**  
**304/305**

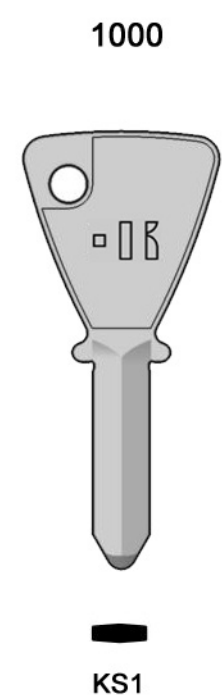

**OPZ06711B**  
Morsetto C11  
Jaw C11  
Spannbacke C11  
Étau C11  
Mordaza C11  
**OPTIONAL**

90°

0.4 mm

**RIC05044B**  
Fresino V001  
Cutter V001  
Fräser V001  
Fraise V001  
Fresa V001  
**STANDARD**

82°

0.5 mm

**RIC05084B**  
Fresino V004  
Cutter V004  
Fräser V004  
Fraise V004  
Fresa V004  
**OPTIONAL**



**NINJA TOTAL**  
**NINJA VORTEX**  
**VERSA**

2000

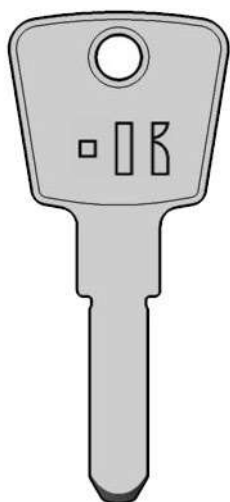

KS13



2500-4000-8000

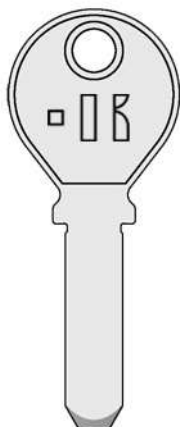

KS2

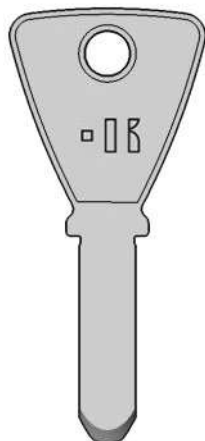

KS3



**303/304/305**

**T-REX  
T-REX ADVANCE**

**PUNTO**

**OPTIONAL**

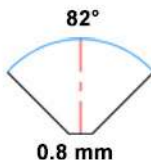

**RIC01783B**  
Fresino HB026  
Cutter HB026  
Fräser HB026  
Fraise HB026  
Fresa HB026

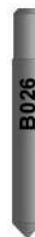

**RIC01784B**  
Tastatore B026  
Tracer Point B026  
Taster B026  
Palpeur B026  
Palpador B026



**NINJA TOTAL**

**NINJA VORTEX**



**VERSA**

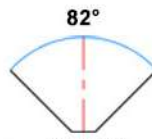

**0.5 mm**  
**RIC05084B**  
Fresino V004  
Cutter V004  
Fräser V004  
Fraise V004  
Fresa V004  
**OPTIONAL**

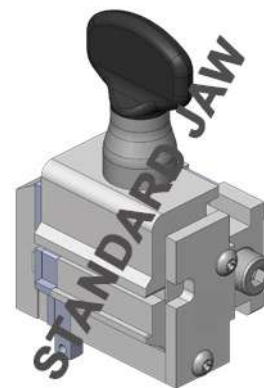

**OPTIONAL**

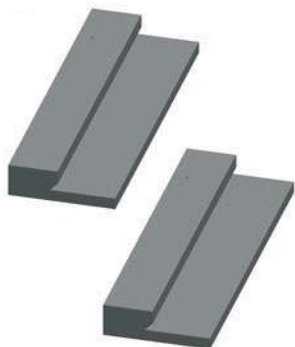

**OPZ06644B**  
*Adattatori per Kaba Micro e KYR*  
*Adaptors for Kaba Micro and KYR*  
*Adaptors für Kaba Micro und KYR*  
*Adaptateurs pour Kaba Micro et KYR*  
*Adaptadores para Kaba Micro y KYR*



**303/304/305**



**T-REX  
T-REX ADVANCE**



**KYR1**

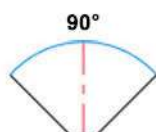

0.4 mm



**RIC05044B**  
*Fresino V001*  
*Cutter V001*  
*Fräser V001*  
*Fraise V001*  
*Fresa V001*  
**STANDARD**

**OPZ07800B**  
*Morsetto C15*  
*Jaw C15*  
*Spannbacke C15*  
*Étau C15*  
*Mordaza C15*  
**OPTIONAL**



**NINJA TOTAL**



**NINJA VORTEX**



**VERSA**



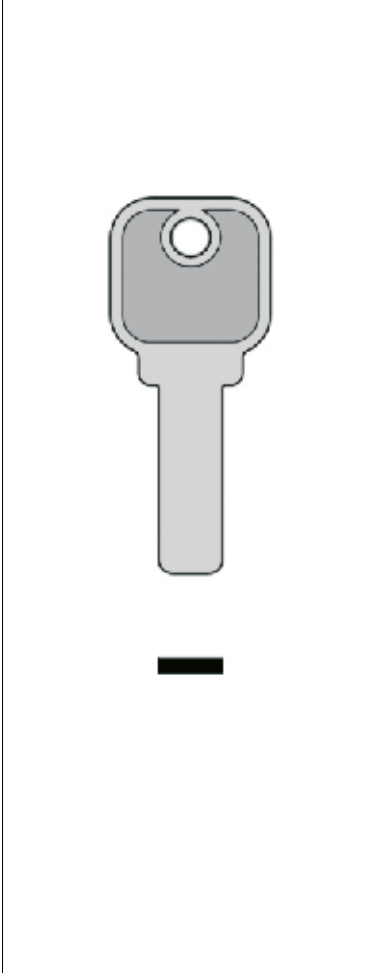

**STANDARD**

**90°**  
**0.45 mm**

**RIC01793B**  
*Fresino HB020*  
*Cutter HB020*  
*Fräser HB020*  
*Fraise HB020*  
*Fresa HB020*

**HB020**

**B020**

**RIC01794B**  
*Tastatore B020*  
*Tracer Point B020*  
*Taster B020*  
*Palpeur B020*  
*Palpador B020*



**OPTIONAL**

**3,0 mm**

**RIC01715B**  
*Fresino HC030*  
*Cutter HC030*  
*Fräser HC030*  
*Fraise HC030*  
*Fresa HC030*

**HC030**

**C030**

**RIC01716B**  
*Tastatore C030*  
*Tracer Point C030*  
*Taster C030*  
*Palpeur C030*  
*Palpador C030*

**STANDARD**

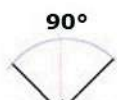

0.45 mm

**RIC01793B**  
Fresino HB020  
Cutter HB020  
Fräser HB020  
Fraise HB020  
Fresa HB020



**RIC01794B**  
Tastatore B020  
Tracer Point B020  
Taster B020  
Palpeur B020  
Palpador B020



**303/304/305**



**T-REX  
T-REX ADVANCE**



**PUNTO**

XA/XB/XC  
XD/XE

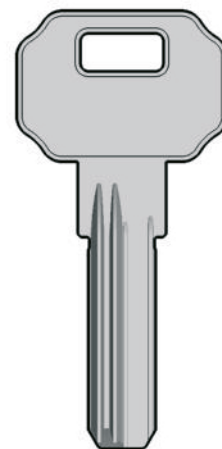

4.0 mm

**RIC05044B**  
Fresino V001  
Cutter V001  
Fräser V001  
Fraise V001  
Fresa V001  
**STANDARD**



**OPZ05701B**  
Morsetto C03  
Jaw C03  
Spannbacke C03  
Étau C03  
Mordaza C03  
**OPTIONAL**



**NINJA TOTAL**



**NINJA VORTEX**



**VERSA**

2000

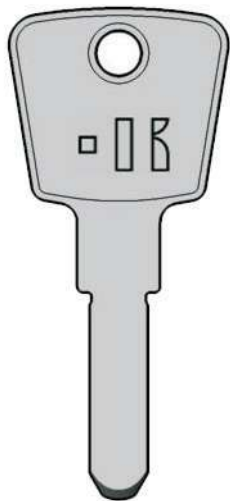

KS13



**303/304/305**



**T-REX  
T-REX ADVANCE**



**PUNTO**

**STANDARD**

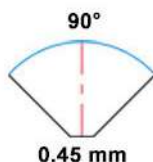

**RIC01793B**  
Fresino HB020  
Cutter HB020  
Fräser HB020  
Fraise HB020  
Fresa HB020



**RIC01794B**  
Tastatore B020  
Tracer Point B020  
Taster B020  
Palpeur B020  
Palpador B020

**OPTIONAL**

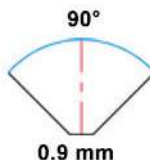

**RIC01775B**  
Fresino HB005  
Cutter HB005  
Fräser HB005  
Fraise HB005  
Fresa HB005

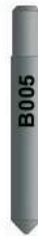

**RIC01776B**  
Tastatore B005  
Tracer Point B005  
Taster B005  
Palpeur B005  
Palpador B005

**OPTIONAL**

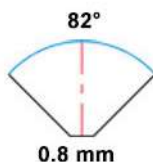

**RIC01783B**  
Fresino HB026  
Cutter HB026  
Fräser HB026  
Fraise HB026  
Fresa HB026



**RIC01784B**  
Tastatore B026  
Tracer Point B026  
Taster B026  
Palpeur B026  
Palpador B026



**NINJA TOTAL**



**NINJA VORTEX**



**VERSA**

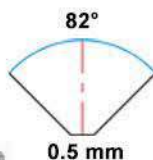

**RIC05084B**  
Fresino V004  
Cutter V004  
Fräser V004  
Fraise V004  
Fresa V004  
OPTIONAL

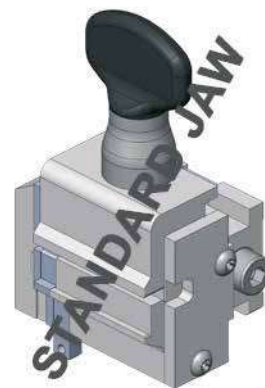

**OPTIONAL**

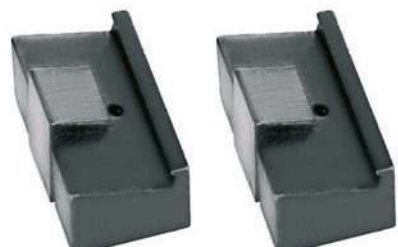

**MK5**  
Adattatori per chiavi Keso 5°  
Adaptors for Keso 5° keys  
Adapters für Keso 5°-Schlüssel  
Adaptateurs pour clés Keso 5°  
Adaptadores para llaves Keso 5°



**T-REX**

**STANDARD**



**RIC01793B**  
Fresino HB020  
Cutter HB020  
Fräser HB020  
Fraise HB020  
Fresa HB020

**RIC01794B**  
Tastatore B020  
Tracer Point B020  
Taster B020  
Palpeur B020  
Palpador B020

**OPTIONAL**



**RIC01791B**  
Fresino HB001  
Cutter HB001  
Fräser HB001  
Fraise HB001  
Fresa HB001

**RIC01792B**  
Tastatore B001  
Tracer Point B001  
Taster B001  
Palpeur B001  
Palpador B001



**303**



**PUNTO**



**L111**

**OPTIONAL**



**RIC01787B**  
Fresino HB007  
Cutter HB007  
Fräser HB007  
Fraise HB007  
Fresa HB007



**RIC01788B**  
Tastatore B007  
Tracer Point B007  
Taster B007  
Palpeur B007  
Palpador B007

**STANDARD**

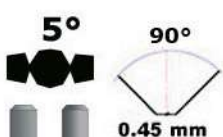

**RIC01793B**  
Fresino HB020  
Cutter HB020  
Fräser HB020  
Fraise HB020  
Fresa HB020

**RIC01794B**  
Tastatore B020  
Tracer Point B020  
Taster B020  
Palpeur B020  
Palpador B020

**OPTIONAL**

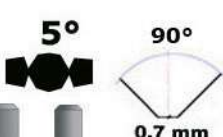

**RIC01791B**  
Fresino HB001  
Cutter HB001  
Fräser HB001  
Fraise HB001  
Fresa HB001

**RIC01792B**  
Tastatore B001  
Tracer Point B001  
Taster B001  
Palpeur B001  
Palpador B001



**T-REX ADVANCE**



**304/305**

**OPTIONAL**



**RIC01787B**  
Fresino HB007  
Cutter HB007  
Fräser HB007  
Fraise HB007  
Fresa HB007



**RIC01788B**  
Tastatore B007  
Tracer Point B007  
Taster B007  
Palpeur B007  
Palpador B007



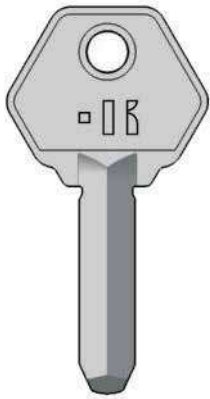

  
L111



**NINJA TOTAL**



**NINJA VORTEX**



**VERSA**



**OPZ06711B**  
Morsetto C11  
Jaw C11  
Spannbacke C11  
Étau C11  
Mordaza C11  
**OPTIONAL**

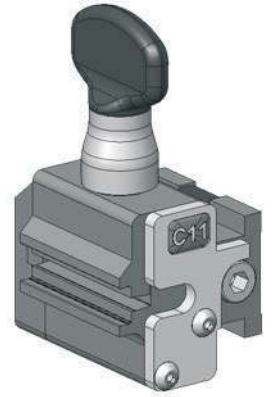

TO  
FIT :

LUMA (E)

OPTIONAL

**OPZ06731B**  
Morsetto 12  
Jaw 12  
Spannbacke 12  
Étau 12  
Mordaza 12

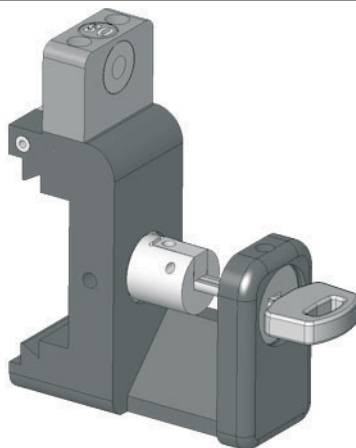

**POWER LYNX  
SIGMA PRO**



**ABU12P**

**PLUS**

TO  
FIT :

M&C (NL)

OPTIONAL

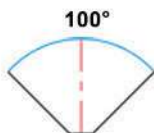

0.4 mm

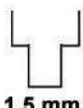

1.5 mm



**RIC05264B**  
Fresino V007  
Cutter V007  
Fräser V007  
Fraise V007  
Fresa V007

**FOR EDGE CUT**



**RIC05274B**  
Fresino V012  
Cutter V012  
Fräser V012  
Fraise V012  
Fresa V012

**FOR LASER CUT**

**OPZ10611B**  
Morsetto C43  
Jaw C43  
Spannbacke C43  
Étau C43  
Mordaza C43



**NINJA VORTEX**



**VERSA**

**MATRIX**

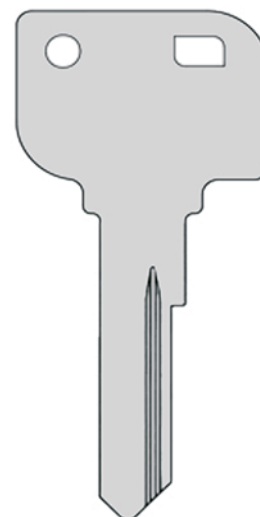

OPTIONAL

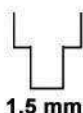

1.5 mm



**RIC05274B**  
Fresino V012  
Cutter V012  
Fräser V012  
Fraise V012  
Fresa V012

**FOR LASER CUT**

**OPZ10611B**  
Morsetto C43  
Jaw C43  
Spannbacke C43  
Étau C43  
Mordaza C43



**NINJA TOTAL**



**CONDOR**

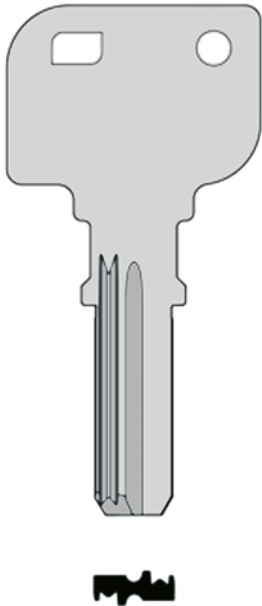

**NINJA TOTAL**



**NINJA VORTEX**



**VERSA**

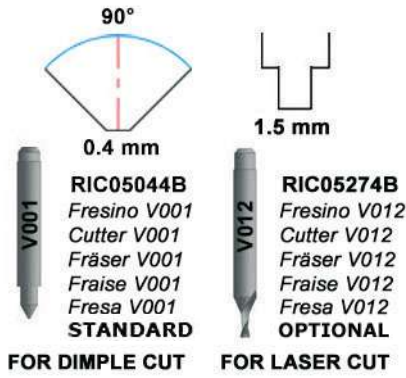

**OPZ10611B**  
Morsetto C43  
Jaw C43  
Spannbacke C43  
Étau C43  
Mordaza C43  
**OPTIONAL**

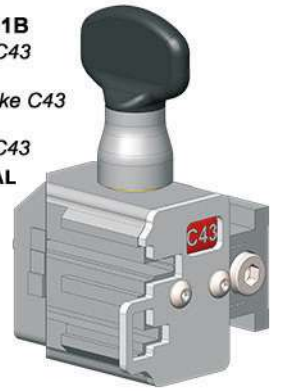

**MAGNUM / ONGUARD MILLECO**

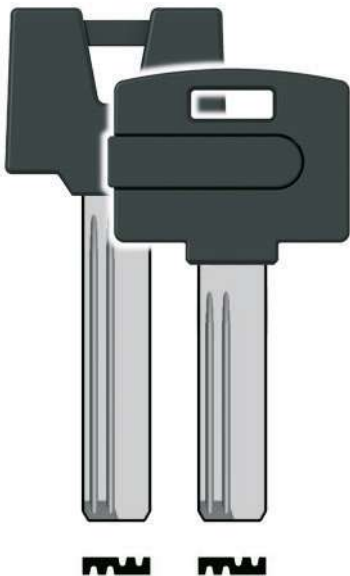

**NINJA TOTAL**



**NINJA VORTEX**



**VERSA**

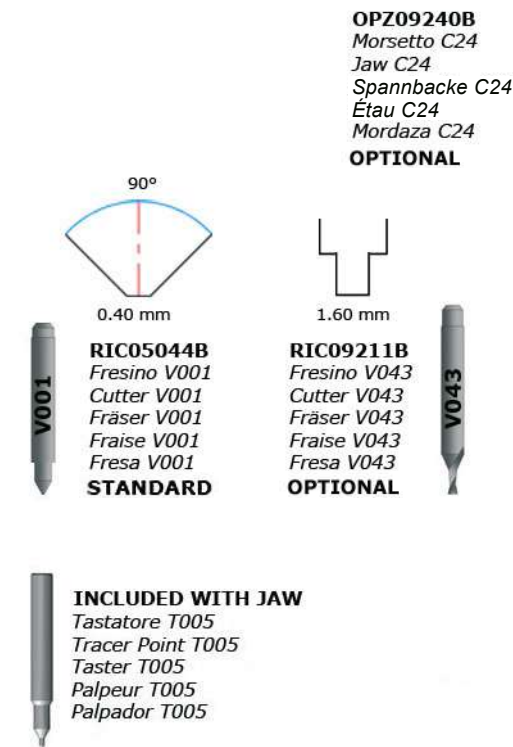

**OPZ09240B**  
Morsetto C24  
Jaw C24  
Spannbacke C24  
Étau C24  
Mordaza C24  
**OPTIONAL**



TO  
FIT :

MAGNUM (CH/UK)

STANDARD

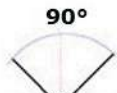

0.45 mm

**RIC01793B**  
Fresino HB020  
Cutter HB020  
Fräser HB020  
Fraise HB020  
Fresa HB020



**RIC01794B**  
Tastatore B020  
Tracer Point B020  
Taster B020  
Palpeur B020  
Palpador B020



**T-REX ADVANCE**



**304/305**

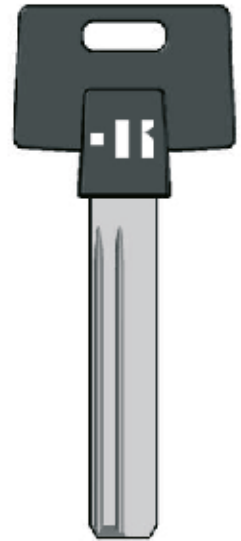

**MGN1SP**

OPTIONAL



1,3 mm

**RIC08491B**  
Fresino HC130  
Cutter HC130  
Fräser HC130  
Fraise HC130  
Fresa HC130



**RIC08492B**  
Tastatore C130  
Tracer Point C130  
Taster C130  
Palpeur C130  
Palpador C130

TO  
FIT :

MAUER (BG)

STANDARD

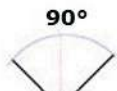

0.45 mm

**RIC01793B**  
Fresino HB020  
Cutter HB020  
Fräser HB020  
Fraise HB020  
Fresa HB020



**RIC01794B**  
Tastatore B020  
Tracer Point B020  
Taster B020  
Palpeur B020  
Palpador B020



**303/304/305**



**T-REX  
T-REX ADVANCE**



**PUNTO**

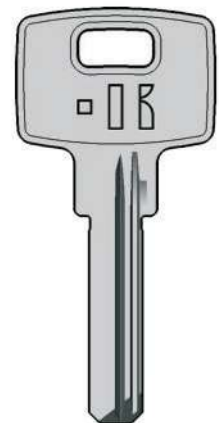

**MA1S**



NW4

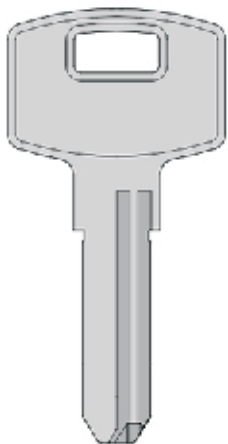

NINJA TOTAL



NINJA VORTEX



VERSA

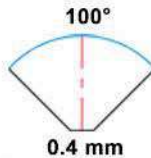

**RIC05264B**  
 Fresino V007  
 Cutter V007  
 Fräser V007  
 Fraise V007  
 Fresa V007  
 OPTIONAL

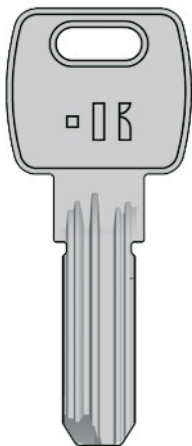
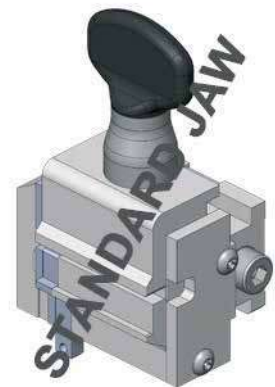

MC15S



303/304/305



T-REX  
 T-REX ADVANCE



PUNTO

STANDARD

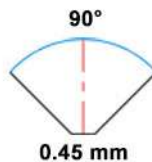

0.45 mm

**RIC01793B**  
 Fresino HB020  
 Cutter HB020  
 Fräser HB020  
 Fraise HB020  
 Fresa HB020



**RIC01794B**  
 Tastatore B020  
 Tracer Point B020  
 Taster B020  
 Palpeur B020  
 Palpador B020

OPTIONAL

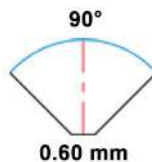

0.60 mm

**RIC01785B**  
 Fresino HB039  
 Cutter HB039  
 Fräser HB039  
 Fraise HB039  
 Fresa HB039



**RIC01786B**  
 Tastatore B039  
 Tracer Point B039  
 Taster B039  
 Palpeur B039  
 Palpador B039

TO  
FIT :

MCM (E)

OPTIONAL

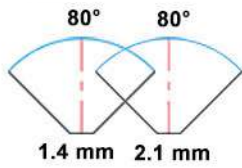

**RIC03964B**  
Fresino HB037  
Cutter HB037  
Fräser HB037  
Fraise HB037  
Fresa HB037



**RIC03965B**  
Tastatore B037  
Tracer Point B037  
Taster B037  
Palpeur B037  
Palpador B037

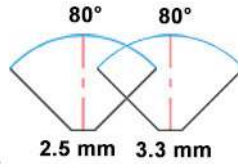

**RIC03970B**  
Fresino HB038  
Cutter HB038  
Fräser HB038  
Fraise HB038  
Fresa HB038



**RIC03971B**  
Tastatore B038  
Tracer Point B038  
Taster B038  
Palpeur B038  
Palpador B038

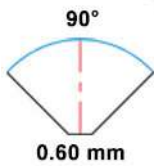

**RIC01785B**  
Fresino HB039  
Cutter HB039  
Fräser HB039  
Fraise HB039  
Fresa HB039



**RIC01786B**  
Tastatore B039  
Tracer Point B039  
Taster B039  
Palpeur B039  
Palpador B039



**303/304/305**



**T-REX  
T-REX ADVANCE**



**PUNTO**

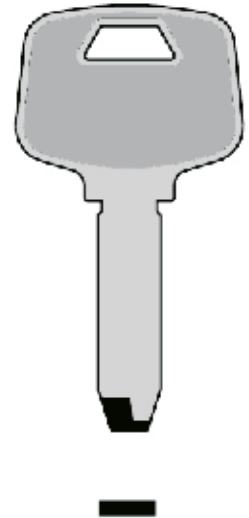

TO  
FIT :

MCM (E)

OPTIONAL

**MCM**

Adattatori per chiavi MCM  
Adaptors for MCM keys  
Adapters für MCM-Schlüssel  
Adaptateurs pour clés MCM  
Adaptadores para llaves MCM

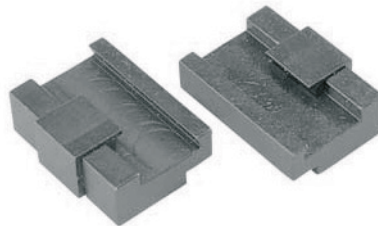

**303/304/305**



**T-REX  
T-REX ADVANCE**



**PUNTO**

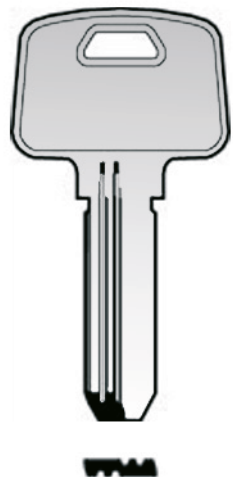

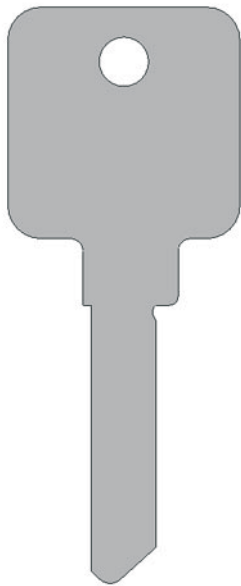

**NINJA TOTAL**



**NINJA VORTEX**



**VERSA**

**OPTIONAL**



**0.87 mm**  
**RIC07785B**  
 Fresino V036  
 Cutter V036  
 Fräser V036  
 Fraise V036  
 Fresa V036

**OPZ08204B**  
 Morsetto C09  
 Jaw C09  
 Spannbacke C09  
 Étau C09  
 Mordaza C09

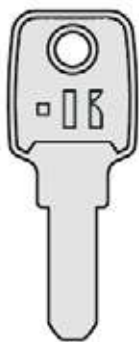
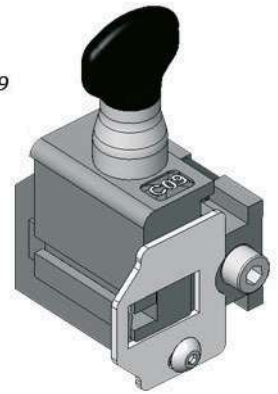

**ME39**



**303/304/305**



**T-REX  
T-REX ADVANCE**



**PUNTO**

**OPTIONAL**



**2.0 mm**

**RIC01816B**  
 Fresino HC044  
 Cutter HC044  
 Fräser HC044  
 Fraise HC044  
 Fresa HC044



**RIC01817B**  
 Tastatore C044  
 Tracer Point C044  
 Taster C044  
 Palpeur C044  
 Palpador C044

**OPZ10306B\***  
 Adattatore AV10 per chiavi Meroni  
 Adaptor AV10 for Meroni keys  
 Adapter AV10 für Meroni-Schlüssel  
 Adaptateur AV10 pour clés Meroni  
 Adaptador AV10 para llaves Meroni



\*Per Tagliare la chiave è necessario ordinare 2 adattatori  
 \*To cut the key it is necessary to order 2 adaptors  
 \*Um die Schlüssel zu schneiden es nöting 2 Adapter zu bestellen  
 \*Pour tailler la clé, il faut commander 2 adaptateurs  
 \*Para cortar la llave es necesario pedir 2 adaptadores

TO  
FIT :

MERONI (I)



2.5 mm



**RIC05048B**  
*Fresino V003*  
*Cutter V003*  
*Fräser V003*  
*Fraise V003*  
*Fresa V003*  
**STANDARD**

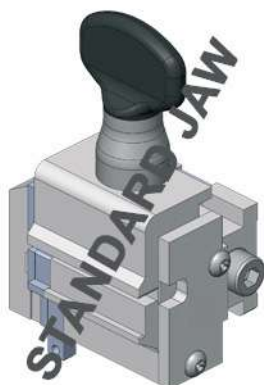

**OPZ10306B**

*Adattatore AV10 per chiavi Meroni*  
*Adaptor AV10 for Meroni keys*  
*Adapter AV10 für Meroni-Schlüssel*  
*Adaptateur AV10 pour clés Meroni*  
*Adaptador AV10 para llaves Meroni*

**OPTIONAL**



**NINJA TOTAL**



**NINJA VORTEX**



**VERSA**



**ME39**

TO  
FIT :

MG MONTI (I)

**STANDARD**

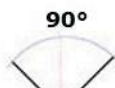

0.45 mm

**RIC01793B**  
*Fresino HB020*  
*Cutter HB020*  
*Fräser HB020*  
*Fraise HB020*  
*Fresa HB020*



**RIC01794B**  
*Tastatore B020*  
*Tracer Point B020*  
*Taster B020*  
*Palpeur B020*  
*Palpador B020*



**303/304/305**



**T-REX  
T-REX ADVANCE**



**PUNTO**

**X8**

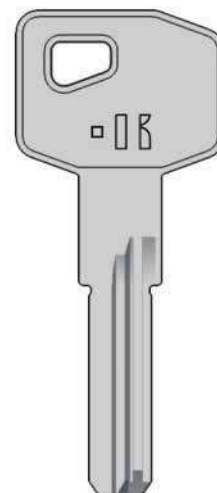

**MN2S**





TO FIT: **MG MONTI (I)**

X8

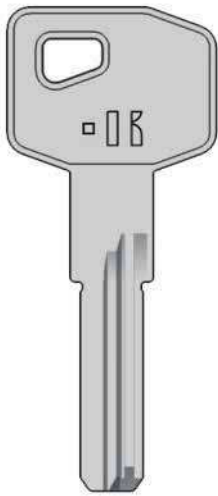

**JPT**  
MN2S



**NINJA TOTAL**



**NINJA VORTEX**



**VERSA**

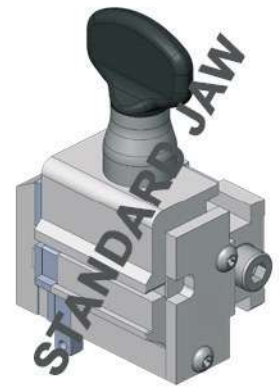
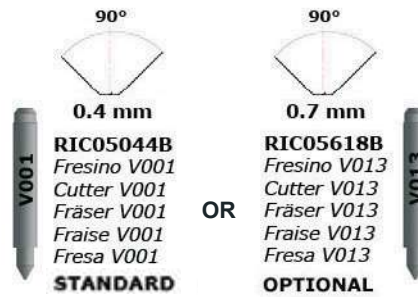

TO FIT: **MG MONTI (I)**

HS

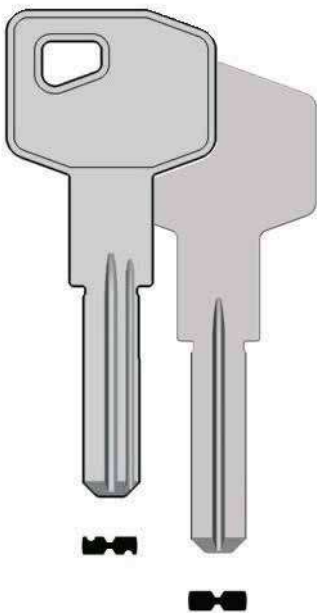

**303/304/305**



**T-REX  
T-REX ADVANCE**



**PUNTO**

**STANDARD**

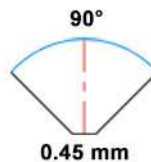

**RIC01793B**  
Fresino HB020  
Cutter HB020  
Fräser HB020  
Fraise HB020  
Fresa HB020

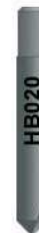

**RIC01794B**  
Tastatore B020  
Tracer Point B020  
Taster B020  
Palpeur B020  
Palpador B020

**OPTIONAL**

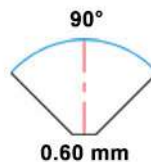

**RIC01785B**  
Fresino HB039  
Cutter HB039  
Fräser HB039  
Fraise HB039  
Fresa HB039



**RIC01786B**  
Tastatore B039  
Tracer Point B039  
Taster B039  
Palpeur B039  
Palpador B039

TO  
FIT :

MG MONTI (I)



OR

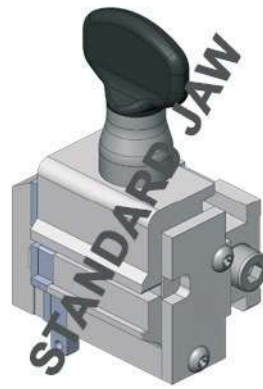

**NINJA TOTAL**



**NINJA VORTEX**



**VERSA**

HS

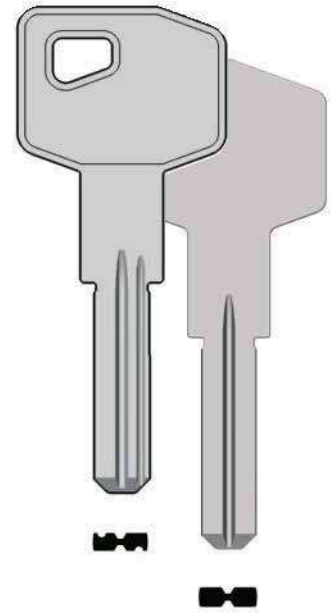

TO  
FIT :

MG MONTI (I)



**OPZ05703B**  
Morsetto C04  
Jaw C04  
Spannbacke C04  
Étau C04  
Mordaza C04  
**OPTIONAL**

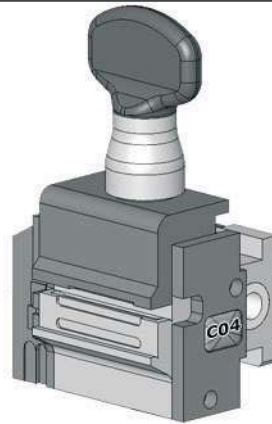

**NINJA TOTAL**



**NINJA VORTEX**



**VERSA**

HSP

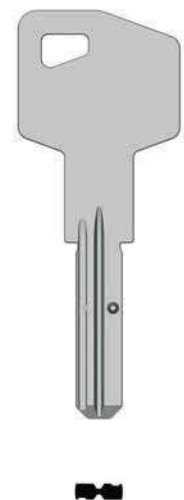

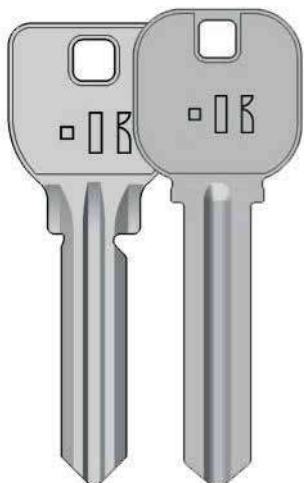

  
KL760

  
KL248



**DEZMO**

**OPTIONAL**

**OPZ08441B**  
*Morsetto Z20 per chiavi giapponesi*  
*Jaw Z20 for japanese keys*  
*Spannbacke Z20 für Japanisch-Schlüssel*  
*Étau Z20 pour clés japonaises*  
*Mordaza para llaves japonesas*

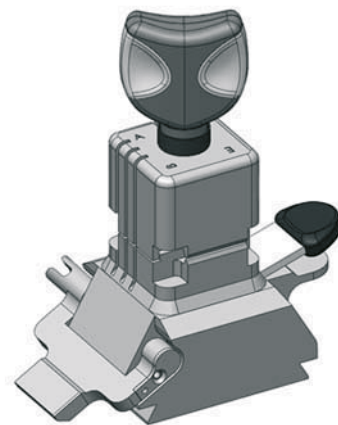

**CARAT/106**

**OPTIONAL**



**RIC08326B**  
*Morsetto 4 facce per chiavi giapponesi*  
*Jaw 4 sides for japanese keys*  
*Spannbacke 4 seiten für Japanisch-Schlüssel*  
*Étau 4 faces pour clés japonaises*  
*Mordaza 4 lados para llaves japonesas*



**NINJA LASER**



**NINJA TOTAL**



**NINJA  
NINJA DARK**

**OPTIONAL**

**OPZ09126B**  
*Morsetto N20 per chiavi Miwa*  
*Jaw N20 for Miwa keys*  
*Spannbacke N20 für Miwa-Schlüssel*  
*Étau N20 pour clés Miwa*  
*Mordaza N20 para llaves Miwa*

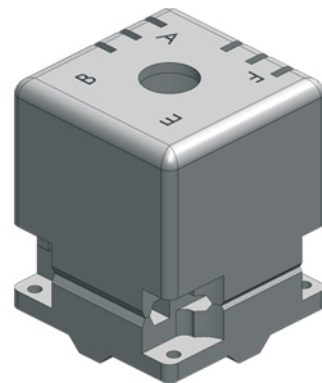

**STANDARD**

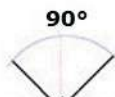

0.45 mm

**RIC01793B**  
Fresino HB020  
Cutter HB020  
Fräser HB020  
Fraise HB020  
Fresa HB020



**RIC01794B**  
Tastatore B020  
Tracer Point B020  
Taster B020  
Palpeur B020  
Palpador B020



**303/304/305**



**T-REX  
T-REX ADVANCE**



**PUNTO**

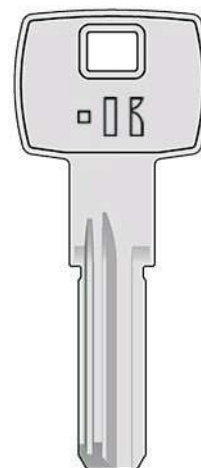

**MRI1**

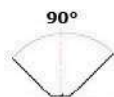

0.4 mm

**RIC05044B**  
Fresino V001  
Cutter V001  
Fräser V001  
Fraise V001  
Fresa V001  
**STANDARD**

OR

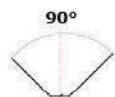

0.7 mm

**RIC05618B**  
Fresino V013  
Cutter V013  
Fräser V013  
Fraise V013  
Fresa V013  
**OPTIONAL**

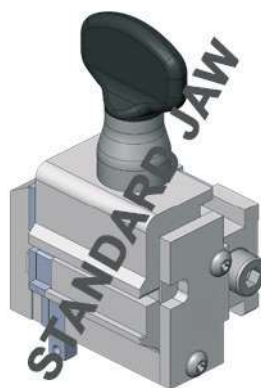

**NINJA TOTAL**



**NINJA VORTEX**



**VERSA**



**DEFENDER**



**MRI1**



**303/304/305**



**T-REX  
T-REX ADVANCE**



**PUNTO**



**NINJA TOTAL**



**NINJA VORTEX**



**VERSA**

**OPTIONAL**

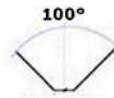

**0.7 mm**

**RIC01789B**  
Fresino HB042  
Cutter HB042  
Fräser HB042  
Fraise HB042  
Fresa HB042



**RIC01790B**  
Tastatore B042  
Tracer Point B042  
Taster B042  
Palpeur B042  
Palpador B042

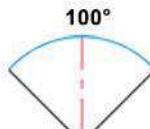

**0.4 mm**



**RIC05264B**  
Fresino V007  
Cutter V007  
Fräser V007  
Fraise V007  
Fresa V007  
**OPTIONAL**

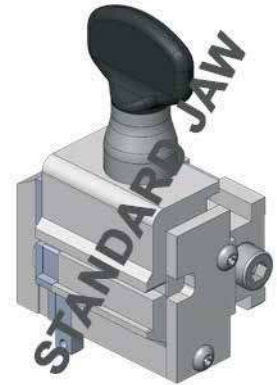

OPTIONAL

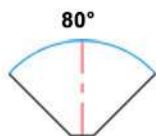

0.70 mm

**RIC03964B**

*Fresino HB037  
Cutter HB037  
Fräser HB037  
Fraise HB037  
Fresa HB037*



**RIC01786B**

*Tastatore B037  
Tracer Point B037  
Taster B037  
Palpeur B037  
Palpador B037*



**303/304/305**



**T-REX  
T-REX ADVANCE**



**PUNTO**

CHAMPIONS

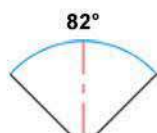

0.5 mm

**RIC05084B**

*Fresino V004  
Cutter V004  
Fräser V004  
Fraise V004  
Fresa V004  
OPTIONAL*

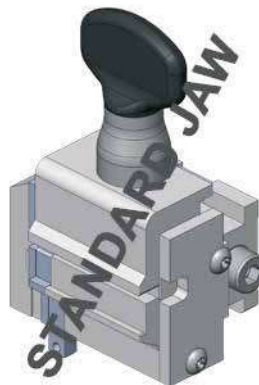

**NINJA TOTAL**



**NINJA VORTEX**



**VERSA**

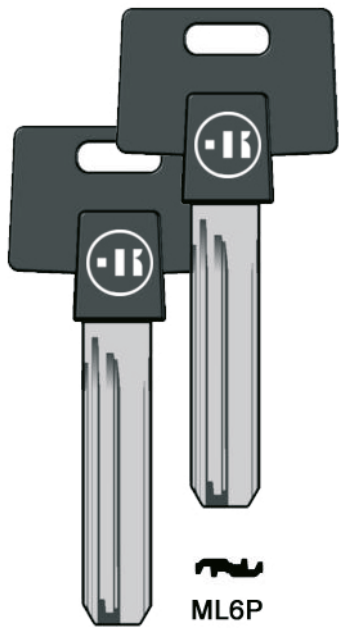

ML6P

ML4P



303/304/305



T-REX  
T-REX ADVANCE



PUNTO

OPTIONAL

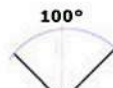

0.3 mm  
**RIC01777B**  
Fresino HB012A  
Cutter HB012A  
Fräser HB012A  
Fraise HB012A  
Fresa HB012A



**RIC01778B**  
Tastatore B012A  
Tracer Point B012A  
Taster B012A  
Palpeur B012A  
Palpador B012A

OPTIONAL

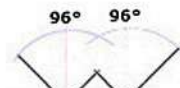

0.3 mm 0.3 mm  
**RIC01779B**  
Fresino HB012B  
Cutter HB012B  
Fräser HB012B  
Fraise HB012B  
Fresa HB012B



**RIC01780B**  
Tastatore B012B  
Tracer Point B012B  
Taster B012B  
Palpeur B012B  
Palpador B012B



NINJA TOTAL



NINJA VORTEX



VERSA

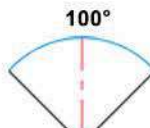

0.4 mm



**RIC05264B**  
Fresino V007  
Cutter V007  
Fräser V007  
Fraise V007  
Fresa V007  
OPTIONAL

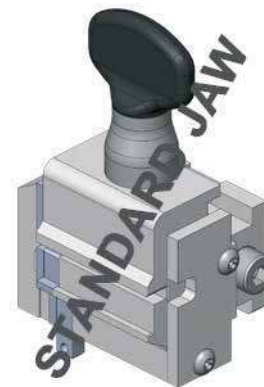

TO  
FIT :

# MUL.T.LOCK (IL)

## OPTIONAL

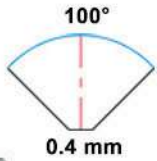

**RIC05264B**  
Fresino V007  
Cutter V007  
Fräser V007  
Fraise V007  
Fresa V007

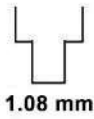

**RIC07782B**  
Fresino V035  
Cutter V035  
Fräser V035  
Fraise V035  
Fresa V035



**OPZ07800B**  
Morsetto C15  
Jaw C15  
Spannbacke C15  
Étau C15  
Mordaza C15



**NINJA TOTAL**



**NINJA VORTEX**



**VERSA**

MT5  
MT5+



TO  
FIT :

# MUL.T.LOCK (IL)

## OPTIONAL

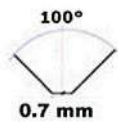

**RIC01789B**  
Fresino HB042  
Cutter HB042  
Fräser HB042  
Fraise HB042  
Fresa HB042



**RIC01790B**  
Tastatore B042  
Tracer Point B042  
Taster B042  
Palpeur B042  
Palpador B042



**303/304/305**



**T-REX  
T-REX ADVANCE**



**PUNTO**



**ML13P**





**OPTIONAL**

**RIC08488B**  
Fresino WB019  
Cutter WB019  
Fräser WB019  
Fraise WB019  
Fresa WB019



**RIC08489B**  
Tastatore B019  
Tracer Point B019  
Taster B019  
Palpeur B019  
Palpador B019



**OPTIONAL**

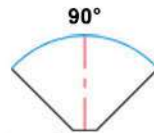

**RIC06368B**  
Fresino V022  
Cutter V022  
Fräser V022  
Fraise V022  
Fresa V022



**INCLUDED WITH JAW**  
Tastatore T005  
Tracer Point T005  
Taster T005  
Palpeur T005  
Palpador T005

**OPZ08506B**  
Morsetto C22  
Jaw C22  
Spannbacke C22  
Étau C22  
Mordaza C22

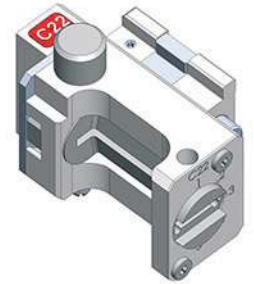

**STANDARD**

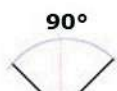

0.45 mm

**RIC01793B**  
Fresino HB020  
Cutter HB020  
Fräser HB020  
Fraise HB020  
Fresa HB020



**RIC01794B**  
Tastatore B020  
Tracer Point B020  
Taster B020  
Palpeur B020  
Palpador B020



**303/304/305**



**T-REX  
T-REX ADVANCE**



**PUNTO**



**OMC13**



0.4 mm

**RIC05044B**  
Fresino V001  
Cutter V001  
Fräser V001  
Fraise V001  
Fresa V001  
**STANDARD**

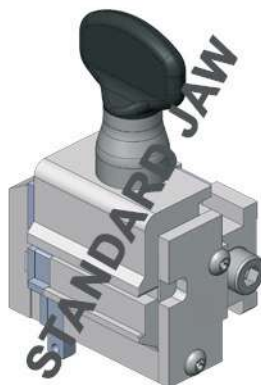

OR

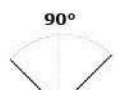

0.7 mm

**RIC05618B**  
Fresino V013  
Cutter V013  
Fräser V013  
Fraise V013  
Fresa V013  
**OPTIONAL**



OR



0.5 mm

**RIC05084B**  
Fresino V004  
Cutter V004  
Fräser V004  
Fraise V004  
Fresa V004  
**OPTIONAL**



**NINJA TOTAL**



**NINJA VORTEX**



**VERSA**



OMC14



**303/304/305**



**T-REX  
T-REX ADVANCE**



**PUNTO**



**NINJA TOTAL**



**NINJA VORTEX**



**VERSA**

**OPTIONAL**

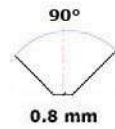

0.8 mm

**RIC01783B**  
Fresino HB026  
Cutter HB026  
Fräser HB026  
Fraise HB026  
Fresa HB026



**RIC01784B**  
Tastatore B026  
Tracer Point B026  
Taster B026  
Palpeur B026  
Palpador B026

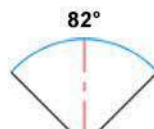

0.5 mm

**RIC05084B**  
Fresino V004  
Cutter V004  
Fräser V004  
Fraise V004  
Fresa V004  
OPTIONAL



OPTIONAL

**OPZ08431B**

Morsetto Z19 per chiavi Pfaffenhain  
Jaw Z19 for Pfaffenhain keys  
Spannbacke Z19 für Pfaffenhain Schlüssel  
Étau Z19 pour clés Pfaffenhain  
Mordaza Z19 para llaves Pfaffenhain

FOR EDGE CUT



**DEZMO**

INTEGRAL

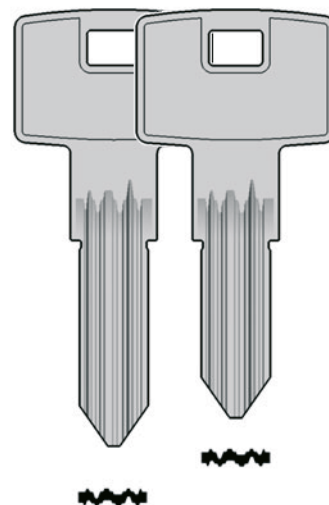

**NINJA TOTAL**



**NINJA VORTEX**



**VERSA**



0.4 mm

**V001**  
**RIC05044B**  
Fresino V001  
Cutter V001  
Fräser V001  
Fraise V001  
Fresa V001  
**STANDARD**

OR

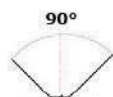

0.7 mm

**V013**  
**RIC05618B**  
Fresino V013  
Cutter V013  
Fräser V013  
Fraise V013  
Fresa V013  
**OPTIONAL**

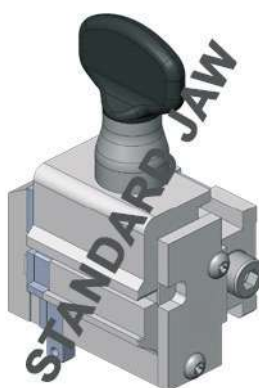

OPTIONAL

**OPZ09531B**

Morsetto N25  
Jaw N25  
Spannbacke N25  
Étau N25  
Mordaza N25

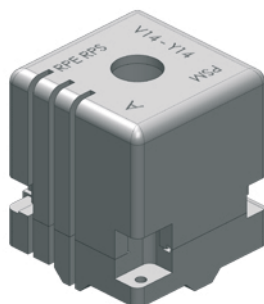

**NINJA LASER**



**NINJA  
NINJA DARK**



TO FIT: PFAFFENHAIN (D)

K14 KV14

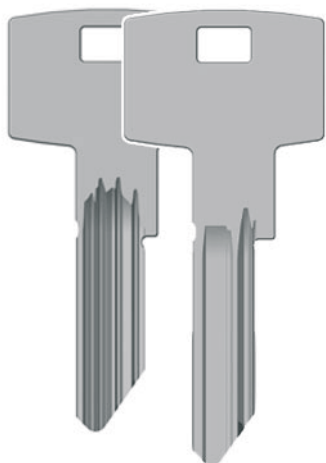

**VERSA**

**OPZ05807B**

Morsetto C07 con adattatori Pfaffenhein  
 Jaw C07 with Pfaffenhein adaptors  
 Spannbacke C07 mit Pfaffenhein Adapters  
 Étau C07 avec adaptateurs Pfaffenhein  
 Mordaza C07 con adaptadores Pfaffenhein

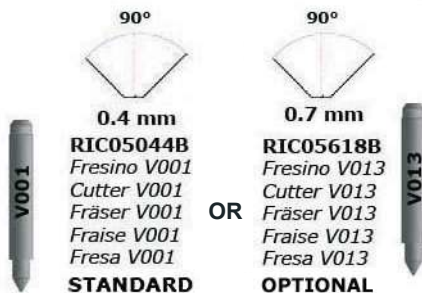

**0.4 mm**  
**RIC05044B**  
 Fresino V001  
 Cutter V001  
 Fräser V001  
 Fraise V001  
 Fresa V001

**0.7 mm**  
**RIC05618B**  
 Fresino V013  
 Cutter V013  
 Fräser V013  
 Fraise V013  
 Fresa V013

**STANDARD**

**OPTIONAL**

**FOR DIMPLE CUT**

**OPTIONAL**

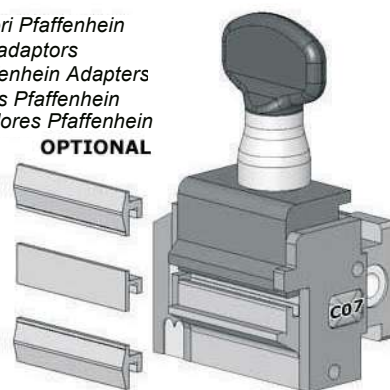

**NINJA LASER**



**NINJA  
 NINJA DARK**

**OPTIONAL**

**OPZ09531B**

Morsetto N25  
 Jaw N25  
 Spannbacke N25  
 Étau N25  
 Mordaza N25

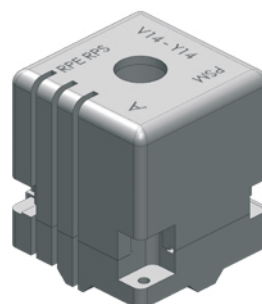

TO FIT: PFAFFENHAIN (D)

WAVYLINE

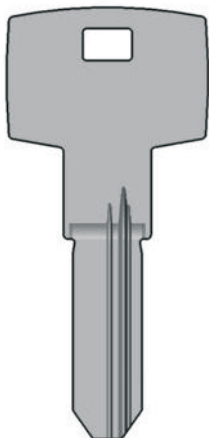

**DEZMO**

**OPTIONAL**

**OPZ08431B**

Morsetto Z19 per chiavi Pfaffenhein  
 Jaw Z19 for Pfaffenhein keys  
 Spannbacke Z19 für Pfaffenhein Schlüssel  
 Étau Z19 pour clés Pfaffenhein  
 Mordaza Z19 para llaves Pfaffenhein

**FOR EDGE CUT**



TO  
FIT :

PFAFFENHAIN (D)

OPTIONAL

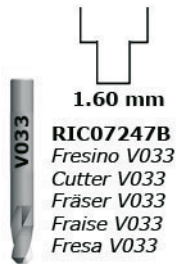

**OPZ07237B**  
Morsetto C13  
Jaw C13  
Spannbacke C13  
Étau C13  
Mordaza C13

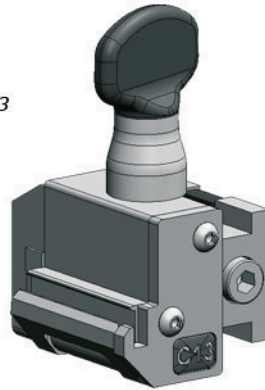

**VERSA**

WAVYLINE

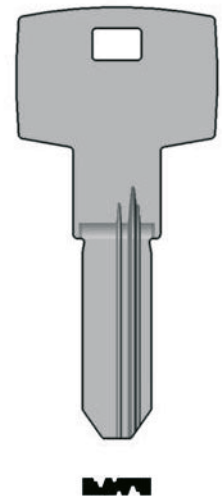

OPTIONAL

**OPZ09531B**  
Morsetto N25  
Jaw N25  
Spannbacke N25  
Étau N25  
Mordaza N25

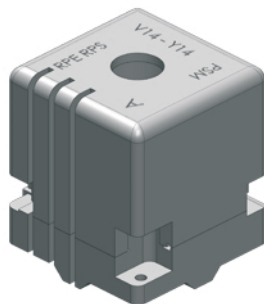

**NINJA LASER**



**NINJA  
NINJA DARK**

TO  
FIT :

PFAFFENHAIN (D)

OPTIONAL

**OPZ08431B**  
Morsetto Z19 per chiavi Pfaffenhain  
Jaw Z19 for Pfaffenhain keys  
Spannbacke Z19 für Pfaffenhain Schlüssel  
Étau Z19 pour clés Pfaffenhain  
Mordaza Z19 para llaves Pfaffenhain

**FOR EDGE CUT**



**DEZMO**

V14



V14



**NINJA LASER**



**NINJA TOTAL**



**NINJA NINJA DARK**



**NINJA VORTEX**



**VERSA**

**OPTIONAL**

**OPZ09531B**  
 Morsetto N25  
 Jaw N25  
 Spannbacke N25  
 Étau N25  
 Mordaza N25

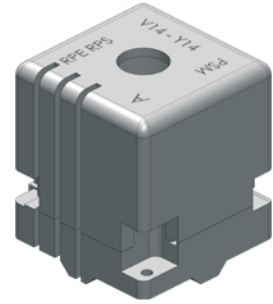

**OPTIONAL**

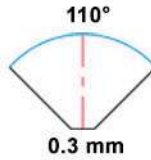

**RIC05270B**  
 Fresino V010  
 Cutter V010  
 Fräser V010  
 Fraise V010  
 Fresa V010

**OPZ06039B**  
 Morsetto C08  
 Jaw C08  
 Spannbacke C08  
 Étau C08  
 Mordaza C08



**OPTIONAL**

**OPZ08431B**

*Morsetto Z19 per chiavi Pfaffenhain  
Jaw Z19 for Pfaffenhain keys  
Spannbacke Z19 für Pfaffenhain Schlüssel  
Étau Z19 pour clés Pfaffenhain  
Mordaza Z19 para llaves Pfaffenhain*

**FOR EDGE CUT**



**DEZMO**

**Y14**



**OPTIONAL**

**OPZ09531B**

*Morsetto N25  
Jaw N25  
Spannbacke N25  
Étau N25  
Mordaza N25*



**NINJA LASER**



**NINJA TOTAL**



**NINJA  
NINJA DARK**



**Prof  
V+XV**



**DEZMO**

**OPTIONAL**

**OPZ08431B**

*Morsetto Z19 per chiavi Pfaffenhain  
Jaw Z19 for Pfaffenhain keys  
Spannbacke Z19 für Pfaffenhain Schlüssel  
Étau Z19 pour clés Pfaffenhain  
Mordaza Z19 para llaves Pfaffenhain*



**FOR EDGE CUT**



**NINJA LASER**

**OPTIONAL**



**NINJA TOTAL**



**NINJA  
NINJA DARK**

**OPZ09531B**

*Morsetto N25  
Jaw N25  
Spannbacke N25  
Étau N25  
Mordaza N25*

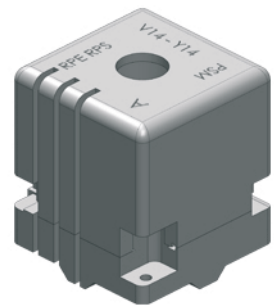

TO  
FIT :

PICARDIE (F)

OPTIONAL

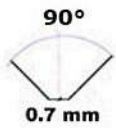

**RIC01791B**  
Fresino HB001  
Cutter HB001  
Fräser HB001  
Fraise HB001  
Fresa HB001



**RIC01792B**  
Tastatore B001  
Tracer Point B001  
Taster B001  
Palpeur B001  
Palpador B001

**303/304/305**



**T-REX  
T-REX ADVANCE**

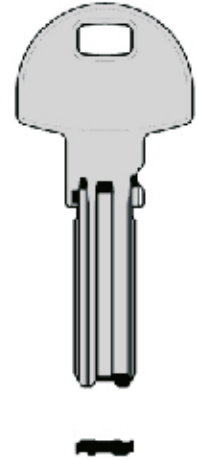

STANDARD

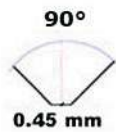

**RIC01793B**  
Fresino HB020  
Cutter HB020  
Fräser HB020  
Fraise HB020  
Fresa HB020



**RIC01794B**  
Tastatore B020  
Tracer Point B020  
Taster B020  
Palpeur B020  
Palpador B020



**PUNTO**

TO  
FIT :

POTENT (I)

OPTIONAL

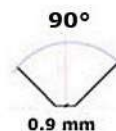

**RIC01775B**  
Fresino HB005  
Cutter HB005  
Fräser HB005  
Fraise HB005  
Fresa HB005



**RIC01776B**  
Tastatore B005  
Tracer Point B005  
Taster B005  
Palpeur B005  
Palpador B005

**303/304/305**



**T-REX  
T-REX ADVANCE**

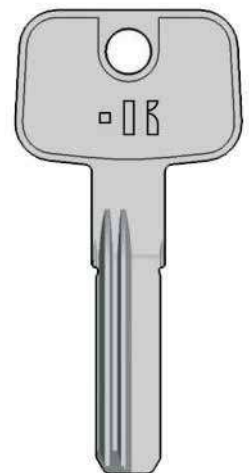

STANDARD

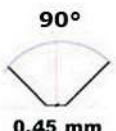

**RIC01793B**  
Fresino HB020  
Cutter HB020  
Fräser HB020  
Fraise HB020  
Fresa HB020



**RIC01794B**  
Tastatore B020  
Tracer Point B020  
Taster B020  
Palpeur B020  
Palpador B020



**PUNTO**

**POT4**

TO FIT: **POTENT (I)**

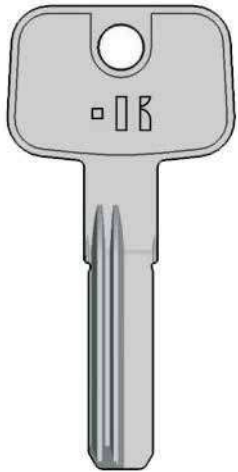

**POT4**



**NINJA TOTAL**



**NINJA VORTEX**



**VERSA**

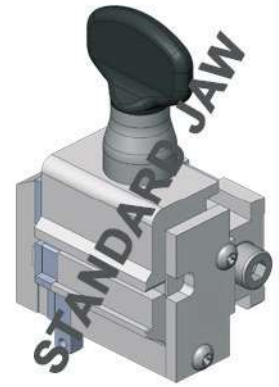
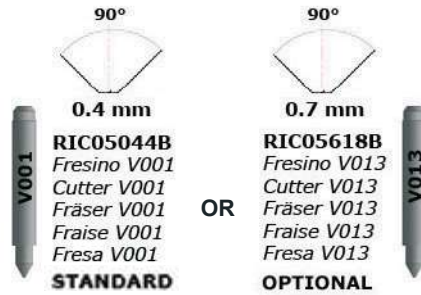

TO FIT: **POTENT (I)**

**4000**



**NINJA TOTAL**



**NINJA VORTEX**



**VERSA**

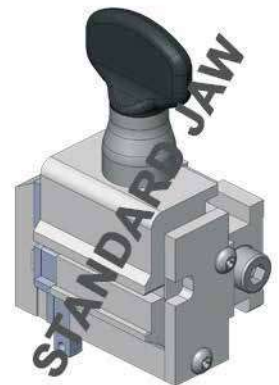

**OPZ10584B**  
*Adattatore AV11*  
*Adaptor AV11*  
*Adapter AV11*  
*Adaptateur AV11*  
*Adaptador AV11*  
**OPTIONAL**



**OPTIONAL**



1.5 mm

**RIC01820B**  
Fresino HC003  
Cutter HC003  
Fräser HC003  
Fraise HC003  
Fresa HC003



**RIC01813B**  
Tastatore C003  
Tracer Point C003  
Taster C003  
Palpeur C003  
Palpador C003

**STANDARD**

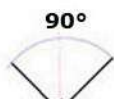

0.45 mm

**RIC01793B**  
Fresino HB020  
Cutter HB020  
Fräser HB020  
Fraise HB020  
Fresa HB020



**RIC01794B**  
Tastatore B020  
Tracer Point B020  
Taster B020  
Palpeur B020  
Palpador B020



**303/304/305**



**T-REX  
T-REX ADVANCE**



**PUNTO**

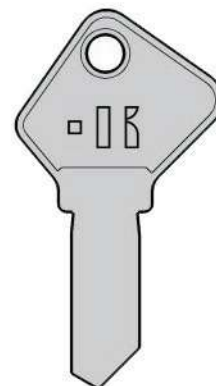

**PR8**



1.5 mm



**RIC05274B**  
Fresino V012  
Cutter V012  
Fräser V012  
Fraise V012  
Fresa V012

**OPTIONAL**

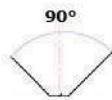

0.4 mm



**RIC05044B**  
Fresino V001  
Cutter V001  
Fräser V001  
Fraise V001  
Fresa V001

**STANDARD**

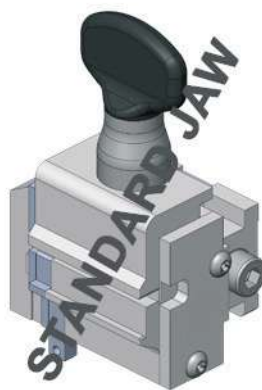

**NINJA TOTAL**



**NINJA VORTEX**



**VERSA**



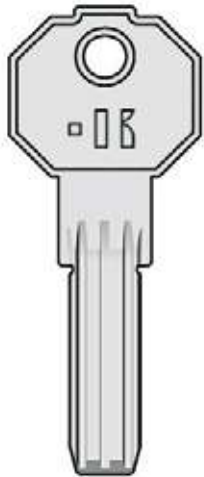

**PR16**



**303/304/305**



**T-REX  
T-REX ADVANCE**



**PUNTO**

**OPTIONAL**

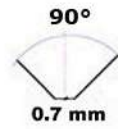

**RIC01791B**  
Fresino HB001  
Cutter HB001  
Fräser HB001  
Fraise HB001  
Fresa HB001



**RIC01792B**  
Tastatore B001  
Tracer Point B001  
Taster B001  
Palpeur B001  
Palpador B001

**STANDARD**

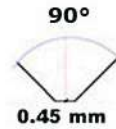

**RIC01793B**  
Fresino HB020  
Cutter HB020  
Fräser HB020  
Fraise HB020  
Fresa HB020



**RIC01794B**  
Tastatore B020  
Tracer Point B020  
Taster B020  
Palpeur B020  
Palpador B020



**NINJA TOTAL**



**NINJA VORTEX**



**VERSA**

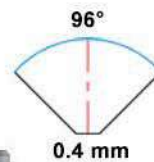

**RIC05262B**  
Fresino V006  
Cutter V006  
Fräser V006  
Fraise V006  
Fresa V006  
**OPTIONAL**

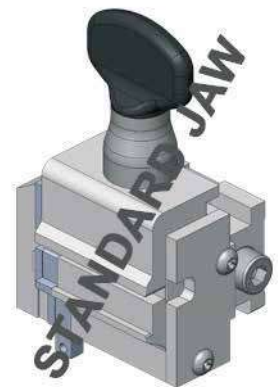

OPTIONAL



1.5 mm

**RIC01820B**  
Fresino HC003  
Cutter HC003  
Fräser HC003  
Fraise HC003  
Fresa HC003



**RIC01813B**  
Tastatore C003  
Tracer Point C003  
Taster C003  
Palpeur C003  
Palpador C003



**303/304/305**



**T-REX  
T-REX ADVANCE**



**PUNTO**

20 / 23

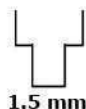
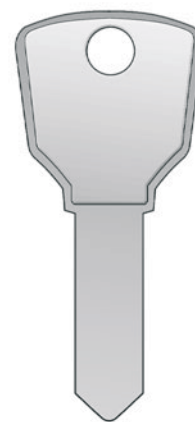

1.5 mm

**RIC05274B**  
Fresino V012  
Cutter V012  
Fräser V012  
Fraise V012  
Fresa V012

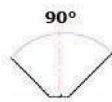

0.4 mm

**RIC05044B**  
Fresino V001  
Cutter V001  
Fräser V001  
Fraise V001  
Fresa V001



OPTIONAL

STANDARD

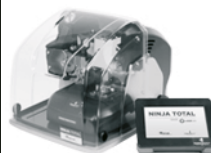
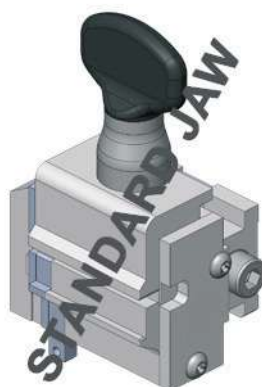

**NINJA TOTAL**



**NINJA VORTEX**



**VERSA**

K1

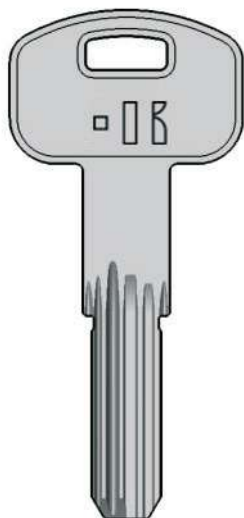

**SEC9**



**303/304/305**



**T-REX  
T-REX ADVANCE**



**PUNTO**

**STANDARD**

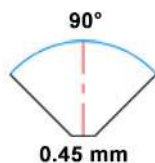

0.45 mm

**RIC01793B**  
Fresino HB020  
Cutter HB020  
Fräser HB020  
Fraise HB020  
Fresa HB020



**RIC01794B**  
Tastatore B020  
Tracer Point B020  
Taster B020  
Palpeur B020  
Palpador B020

**OPTIONAL**

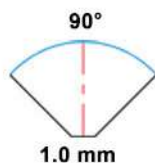

1.0 mm

**RIC01822B**  
Fresino HB043  
Cutter HB043  
Fräser HB043  
Fraise HB043  
Fresa HB043



**RIC01823B**  
Tastatore B043  
Tracer Point B043  
Taster B043  
Palpeur B043  
Palpador B043



**NINJA TOTAL**



**NINJA VORTEX**



**VERSA**



0.4 mm

**RIC05044B**  
Fresino V001  
Cutter V001  
Fräser V001  
Fraise V001  
Fresa V001  
**STANDARD**



OR



0.7 mm

**RIC05618B**  
Fresino V013  
Cutter V013  
Fräser V013  
Fraise V013  
Fresa V013  
**OPTIONAL**

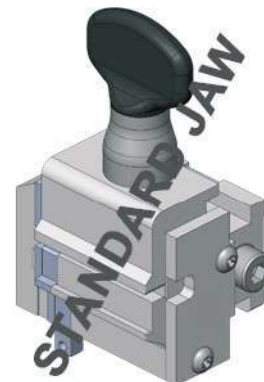

TO  
FIT :

# SECUREMME (I)



0.4 mm



**RIC05044B**  
Fresino V001  
Cutter V001  
Fräser V001  
Fraise V001  
Fresa V001  
**STANDARD**



**OPZ10584B**  
Adattatore AV11  
Adaptor AV11  
Adapter AV11  
Adaptateur AV11  
Adaptador AV11  
**OPTIONAL**



**NINJA TOTAL**



**NINJA VORTEX**



**VERSA**

K2

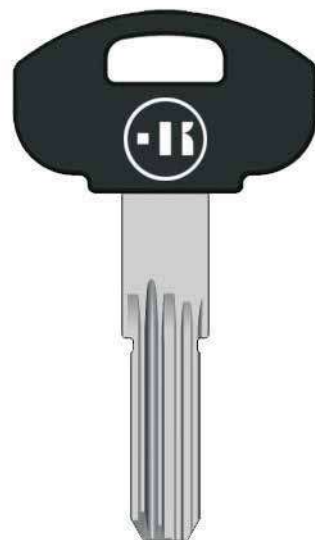

  
SEC11P

TO  
FIT :

# SECUREMME (I)

**STANDARD**

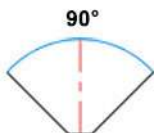

0.45 mm



**RIC01793B**  
Fresino HB020  
Cutter HB020  
Fräser HB020  
Fraise HB020  
Fresa HB020

**RIC01794B**  
Tastatore B020  
Tracer Point B020  
Taster B020  
Palpeur B020  
Palpador B020



**303/304/305**



**T-REX  
T-REX ADVANCE**



**PUNTO**

K3



PROTECTED  
SYSTEM  

**OPTIONAL**

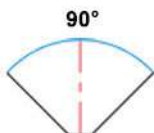

0.9 mm



**RIC01775B**  
Fresino HB005  
Cutter HB005  
Fräser HB005  
Fraise HB005  
Fresa HB005

**RIC01776B**  
Tastatore B005  
Tracer Point B005  
Taster B005  
Palpeur B005  
Palpador B005



TO FIT: SECUREMME (I)

K3

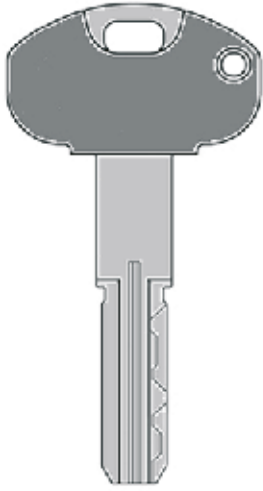

**NINJA TOTAL**



**NINJA VORTEX**



**VERSA**

OPTIONAL

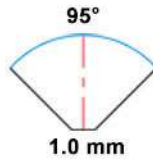

**RIC08161B**  
Fresino V039  
Cutter V039  
Fräser V039  
Fraise V039  
Fresa V039

**OPZ10407B**

Morsetto C37  
Jaw C37  
Spannbacke C37  
Étau C37  
Mordaza C37



TO FIT: SECUREMME (I)

K5

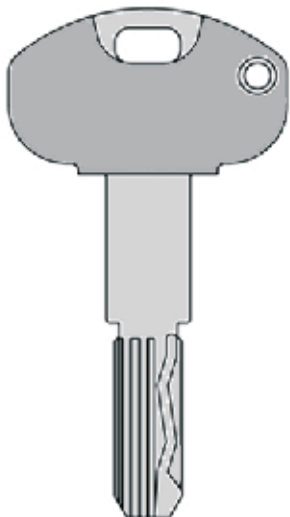

**NINJA TOTAL**



**NINJA VORTEX**



**VERSA**

OPTIONAL

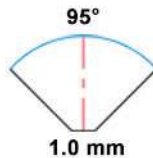

**RIC08161B**  
Fresino V039  
Cutter V039  
Fräser V039  
Fraise V039  
Fresa V039

**OPZ10407B**

Morsetto C37  
Jaw C37  
Spannbacke C37  
Étau C37  
Mordaza C37



TO  
FIT :

# SECUREMME (I)

**OPTIONAL**

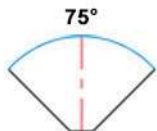

1.2 mm



**RIC10506B**  
Fresino V050  
Cutter V050  
Fräser V050  
Fraise V050  
Fresa V050

**OPZ10407B**  
Morsetto C37  
Jaw C37  
Spannbacke C37  
Étau C37  
Mordaza C37



**NINJA TOTAL**



**NINJA VORTEX**



**VERSA**

**EVOK22/EVOK64**

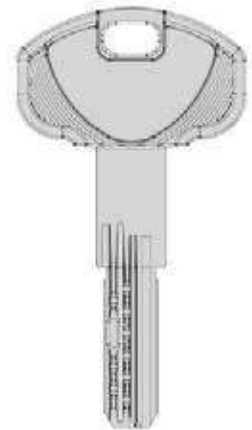

**YMA**



TO  
FIT :

# SECURYSTAR (F)

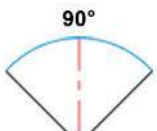

0.4 mm



**RIC05044B**  
Fresino V001  
Cutter V001  
Fräser V001  
Fraise V001  
Fresa V001  
**STANDARD**

**OPZ10143B**  
Morsetto C31  
Jaw C31  
Spannbacke C31  
Étau C31  
Mordaza C31  
**OPTIONAL**



**NINJA TOTAL**



**NINJA VORTEX**



**VERSA**

**MAXISTAR  
PROSTAR**





**KYR1**



**303/304/305**



**T-REX  
T-REX ADVANCE**



**NINJA TOTAL**



**NINJA VORTEX**



**VERSA**

**OPTIONAL**

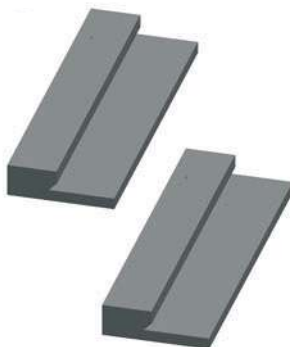

**OPZ06644B**

*Adattatori per Kaba Micro e KYR  
Adaptors for Kaba Micro and KYR  
Adaptors für Kaba Micro und KYR  
Adaptateurs pour Kaba Micro et KYR  
Adaptadores para Kaba Micro y KYR*

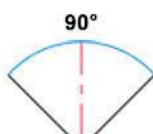

**0.4 mm**



**RIC05044B**  
*Fresino V001  
Cutter V001  
Fräser V001  
Fraise V001  
Fresa V001  
STANDARD*

**OPZ07800B**

*Morsetto C15  
Jaw C15  
Spannbacke C15  
Étau C15  
Mordaza C15  
OPTIONAL*



**OPTIONAL**

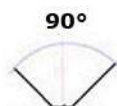

0.9 mm

**RIC01775B**

Fresino HB005  
Cutter HB005  
Fräser HB005  
Fraise HB005  
Fresa HB005



**RIC01776B**

Tastatore B005  
Tracer Point B005  
Taster B005  
Palpeur B005  
Palpador B005

**STANDARD**

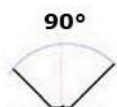

0.45 mm

**RIC01793B**

Fresino HB020  
Cutter HB020  
Fräser HB020  
Fraise HB020  
Fresa HB020



**RIC01794B**

Tastatore B020  
Tracer Point B020  
Taster B020  
Palpeur B020  
Palpador B020



**303/304/305**



**T-REX  
T-REX ADVANCE**



**PUNTO**

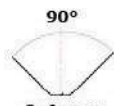
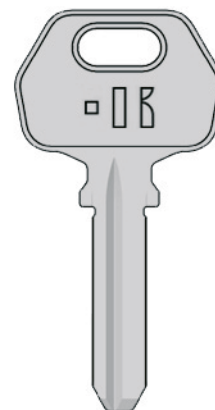

0.4 mm

**RIC05044B**

Fresino V001  
Cutter V001  
Fräser V001  
Fraise V001  
Fresa V001



0.7 mm

**RIC05618B**

Fresino V013  
Cutter V013  
Fräser V013  
Fraise V013  
Fresa V013



OR

**STANDARD**

**OPTIONAL**

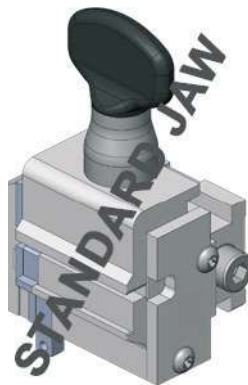

**NINJA TOTAL**



**NINJA VORTEX**



**VERSA**



**STS MINI  
MEGA 6**



**STS6S**



**STANDARD**

90°

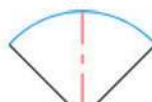

0.45 mm

**RIC01793B**  
Fresino HB020  
Cutter HB020  
Fräser HB020  
Fraise HB020  
Fresa HB020



**RIC01794B**  
Tastatore B020  
Tracer Point B020  
Taster B020  
Palpeur B020  
Palpador B020



**MSTS**

Adattatori per chiavi STS  
Adaptors for STS keys  
Adapters für STS-Schlüssel  
Adaptateurs pour clés STS  
Adaptadores para llaves STS

**OPTIONAL**

**OPTIONAL**

90°



1.0 mm

**RIC01822B**  
Fresino HB043  
Cutter HB043  
Fräser HB043  
Fraise HB043  
Fresa HB043



**RIC01823B**  
Tastatore B043  
Tracer Point B043  
Taster B043  
Palpeur B043  
Palpador B043



90°



0.4 mm



**RIC05044B**  
Fresino V001  
Cutter V001  
Fräser V001  
Fraise V001  
Fresa V001  
**STANDARD**

90°



0.7 mm



**RIC05618B**  
Fresino V013  
Cutter V013  
Fräser V013  
Fraise V013  
Fresa V013  
**OPTIONAL**

OR

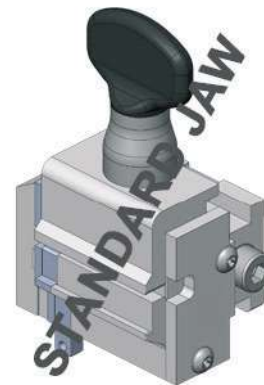

TO  
FIT :

STS (E)

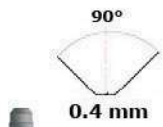

0.4 mm

**RIC05044B**  
Fresino V001  
Cutter V001  
Fräser V001  
Fraise V001  
Fresa V001  
**STANDARD**

OR

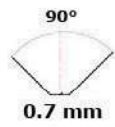

0.7 mm

**RIC05618B**  
Fresino V013  
Cutter V013  
Fräser V013  
Fraise V013  
Fresa V013  
**OPTIONAL**

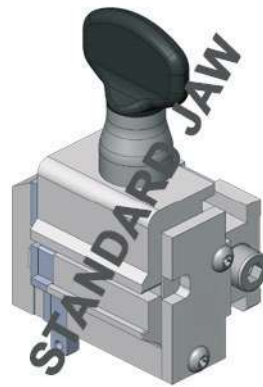

**NINJA TOTAL**



**NINJA VORTEX**



**VERSA**

CS

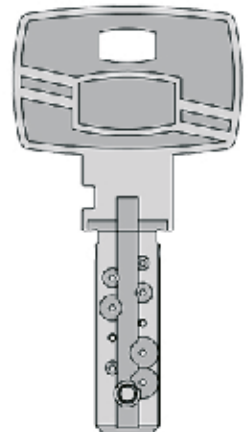

TO  
FIT :

STS (E)

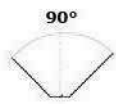

0.8 mm

**RIC06104B**  
Fresino V021  
Cutter V021  
Fräser V021  
Fraise V021  
Fresa V021  
**OPTIONAL**

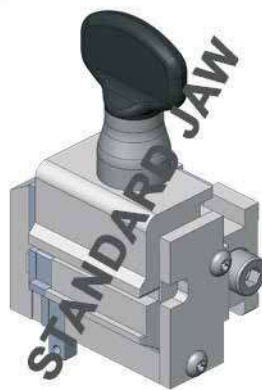

**NINJA TOTAL**



**NINJA VORTEX**



**VERSA**

ST8+ST6

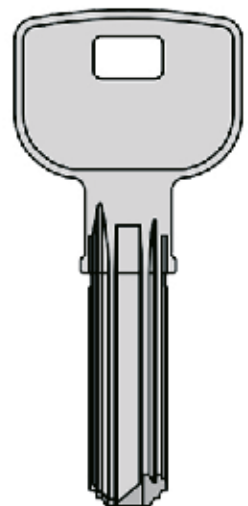

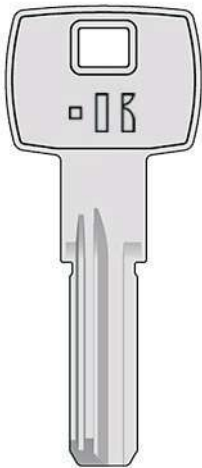

**MRI1**



**303/304/305**



**T-REX  
T-REX ADVANCE**



**PUNTO**



**NINJA TOTAL**



**NINJA VORTEX**



**VERSA**

**STANDARD**

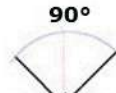

**0.45 mm**

**RIC01793B**  
Fresino HB020  
Cutter HB020  
Fräser HB020  
Fraise HB020  
Fresa HB020



**RIC01794B**  
Tastatore B020  
Tracer Point B020  
Taster B020  
Palpeur B020  
Palpador B020

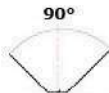

**0.4 mm**



**RIC05044B**  
Fresino V001  
Cutter V001  
Fräser V001  
Fraise V001  
Fresa V001  
**STANDARD**

**OR**

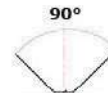

**0.7 mm**



**RIC05618B**  
Fresino V013  
Cutter V013  
Fräser V013  
Fraise V013  
Fresa V013  
**OPTIONAL**

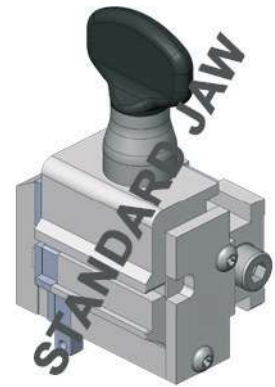

**STANDARD**

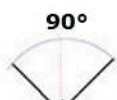

0.45 mm

**RIC01793B**  
Fresino HB020  
Cutter HB020  
Fräser HB020  
Fraise HB020  
Fresa HB020



**RIC01794B**  
Tastatore B020  
Tracer Point B020  
Taster B020  
Palpeur B020  
Palpador B020



**303/304/305**



**PUNTO**

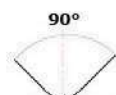
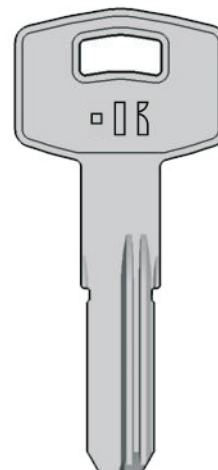

0.4 mm



**RIC05044B**  
Fresino V001  
Cutter V001  
Fräser V001  
Fraise V001  
Fresa V001

**STANDARD**

OR

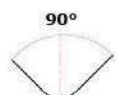

0.7 mm



**RIC05618B**  
Fresino V013  
Cutter V013  
Fräser V013  
Fraise V013  
Fresa V013

**OPTIONAL**

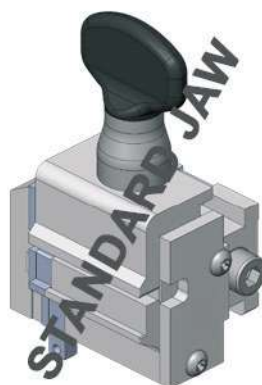

**NINJA TOTAL**



**NINJA VORTEX**



**VERSA**



TAR7



TAR7S



TX70 / TX80



**MLN**



**303/304/305**

**T-REX  
T-REX ADVANCE**

**PUNTO**



**NINJA TOTAL**



**NINJA VORTEX**



**VERSA**

**STANDARD**

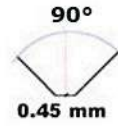

**RIC01793B**  
Fresino HB020  
Cutter HB020  
Fräser HB020  
Fraise HB020  
Fresa HB020



**RIC01794B**  
Tastatore B020  
Tracer Point B020  
Taster B020  
Palpeur B020  
Palpador B020

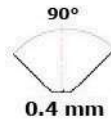

**RIC05044B**  
Fresino V001  
Cutter V001  
Fräser V001  
Fraise V001  
Fresa V001  
**STANDARD**

OR

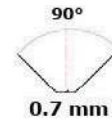

**RIC05618B**  
Fresino V013  
Cutter V013  
Fräser V013  
Fraise V013  
Fresa V013  
**OPTIONAL**

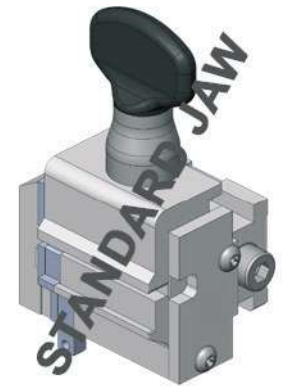

**STANDARD**

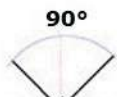

0.45 mm

**RIC01793B**  
Fresino HB020  
Cutter HB020  
Fräser HB020  
Fraise HB020  
Fresa HB020



**RIC01794B**  
Tastatore B020  
Tracer Point B020  
Taster B020  
Palpeur B020  
Palpador B020



**303/304/305**



**T-REX  
T-REX ADVANCE**



**PUNTO**

T60/T80

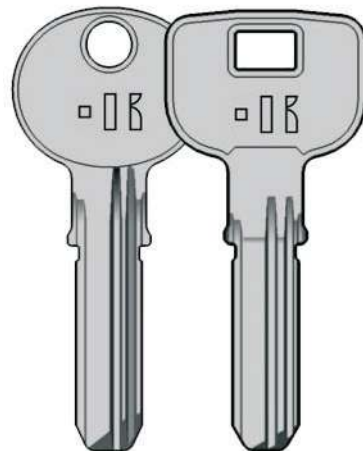

TES7



TES4

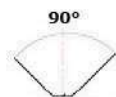

0.4 mm



**RIC05044B**  
Fresino V001  
Cutter V001  
Fräser V001  
Fraise V001  
Fresa V001  
**STANDARD**

OR



0.7 mm



**RIC05618B**  
Fresino V013  
Cutter V013  
Fräser V013  
Fraise V013  
Fresa V013  
**OPTIONAL**

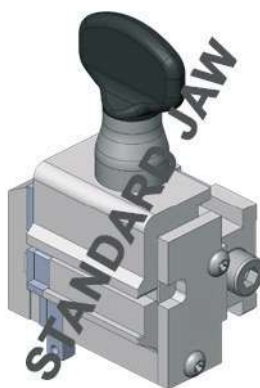

**NINJA TOTAL**



**NINJA VORTEX**



**VERSA**

TO FIT: TESA (E)

T10

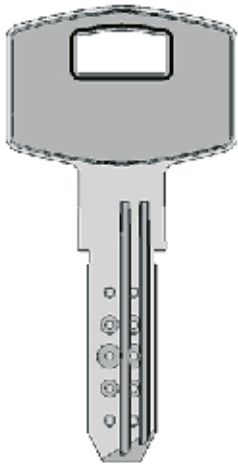

OPTIONAL

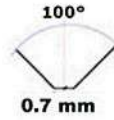

0.7 mm

RIC01789B  
Fresino HB042  
Cutter HB042  
Fräser HB042  
Fraise HB042  
Fresa HB042



RIC01790B  
Tastatore B042  
Tracer Point B042  
Taster B042  
Palpeur B042  
Palpador B042

TO FIT: TESA (E)

ST6

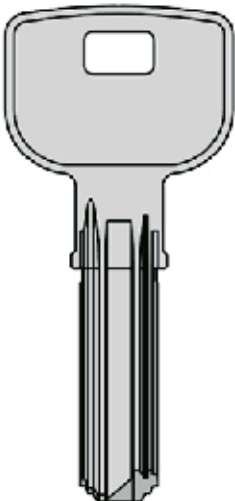

OPTIONAL

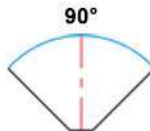

0.8 mm

RIC06104B  
Fresino V021  
Cutter V021  
Fräser V021  
Fraise V021  
Fresa V021



OPZ10454B  
Morsetto C40  
Jaw C40  
Spannbacke C40  
Étau C40  
Mordaza C40



**OPTIONAL**

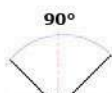

0.8 mm

**RIC01783B**  
Fresino HB026  
Cutter HB026  
Fräser HB026  
Fraise HB026  
Fresa HB026



**RIC01784B**  
Tastatore B026  
Tracer Point B026  
Taster B026  
Palpeur B026  
Palpador B026



**303/304/305**



**T-REX  
T-REX ADVANCE**



**PUNTO**

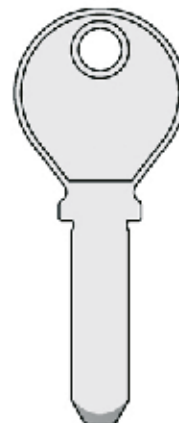

0.5 mm

**RIC05084B**  
Fresino V004  
Cutter V004  
Fräser V004  
Fraise V004  
Fresa V004  
**OPTIONAL**

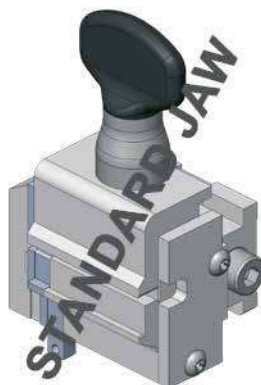

**NINJA TOTAL**



**NINJA VORTEX**



**VERSA**



**KESO**



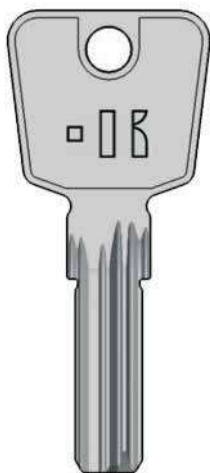

  
TIN7



**303/304/305**  
**T-REX**  
**T-REX ADVANCE**  
**PUNTO**

**STANDARD**



**RIC01793B**  
Fresino HB020  
Cutter HB020  
Fräser HB020  
Fraise HB020  
Fresa HB020



**RIC01794B**  
Tastatore B020  
Tracer Point B020  
Taster B020  
Palpeur B020  
Palpador B020

**OPTIONAL**

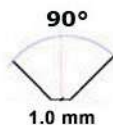

**RIC01822B**  
Fresino HB043  
Cutter HB043  
Fräser HB043  
Fraise HB043  
Fresa HB043



**RIC01823B**  
Tastatore B043  
Tracer Point B043  
Taster B043  
Palpeur B043  
Palpador B043



**NINJA TOTAL**  
**NINJA VORTEX**  
**VERSA**

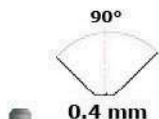

**V001**  
**RIC05044B**  
Fresino V001  
Cutter V001  
Fräser V001  
Fraise V001  
Fresa V001  
**STANDARD**

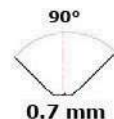

**V013**  
**RIC05618B**  
Fresino V013  
Cutter V013  
Fräser V013  
Fraise V013  
Fresa V013  
**OPTIONAL**

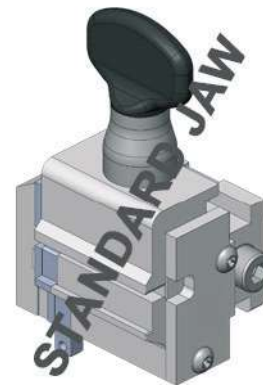

TO  
FIT :

TITAN (SLO)



**RIC05266B**  
*Fresino V008*  
*Cutter V008*  
*Fräser V008*  
*Fraise V008*  
*Fresa V008*

**OPTIONAL**

106°

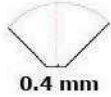

0.4 mm

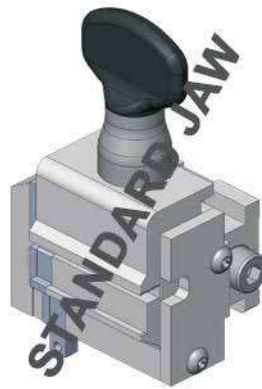

**NINJA TOTAL**



**NINJA VORTEX**



**VERSA**

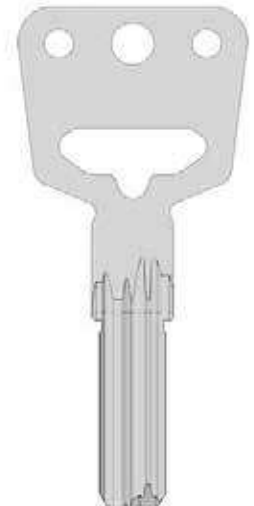

K5  
K5D  
K56  
PPD5BB  
T61BB



TO  
FIT :

TOPEX (US)

**STANDARD**

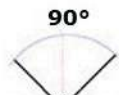

0.45 mm

**RIC01793B**  
*Fresino HB020*  
*Cutter HB020*  
*Fräser HB020*  
*Fraise HB020*  
*Fresa HB020*



**RIC01794B**  
*Tastatore B020*  
*Tracer Point B020*  
*Taster B020*  
*Palpeur B020*  
*Palpador B020*



**303/304/305**



**T-REX  
T-REX ADVANCE**



**PUNTO**

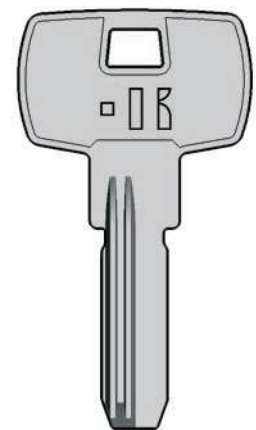

TPX1



**KEY**



**303/304/305**



**T-REX  
T-REX ADVANCE**



**PUNTO**



**NINJA TOTAL**



**NINJA VORTEX**



**VERSA**

**STANDARD**

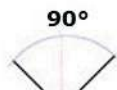

**0.45 mm**

**RIC01793B**  
Fresino HB020  
Cutter HB020  
Fräser HB020  
Fraise HB020  
Fresa HB020



**RIC01794B**  
Tastatore B020  
Tracer Point B020  
Taster B020  
Palpeur B020  
Palpador B020



**0.4 mm**

**RIC05044B**  
Fresino V001  
Cutter V001  
Fräser V001  
Fraise V001  
Fresa V001



**STANDARD**

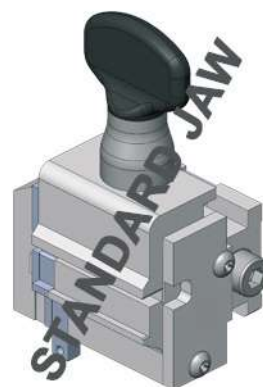

**OR**

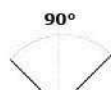

**0.7 mm**

**RIC05618B**  
Fresino V013  
Cutter V013  
Fräser V013  
Fraise V013  
Fresa V013



**OPTIONAL**

**OR**

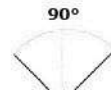

**0.6 mm**

**RIC05612B**  
Fresino V014  
Cutter V014  
Fräser V014  
Fraise V014  
Fresa V014



**OPTIONAL**

TO  
FIT :

TOVER (E)



**RIC05266B**  
*Fresino V008*  
*Cutter V008*  
*Fräser V008*  
*Fraise V008*  
*Fresa V008*

**OPTIONAL**

106°



0.4 mm

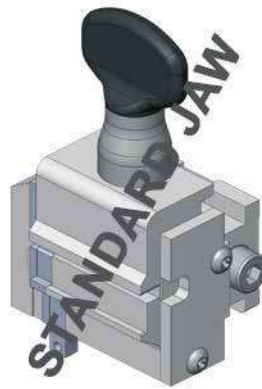

**NINJA TOTAL**



**NINJA VORTEX**



**VERSA**



TO  
FIT :

UCEM (ES)

**OPTIONAL**

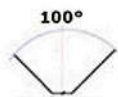

0.7 mm

**RIC01789B**  
*Fresino HB042*  
*Cutter HB042*  
*Fräser HB042*  
*Fraise HB042*  
*Fresa HB042*



**RIC01790B**  
*Tastatore B042*  
*Tracer Point B042*  
*Taster B042*  
*Palpeur B042*  
*Palpador B042*



**303/304/305**



**T-REX  
T-REX ADVANCE**



**PUNTO**



2000





TO FIT: UCEM (ES)

2000



**NINJA TOTAL**



**NINJA VORTEX**



**VERSA**

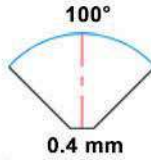

**RIC05264B**  
Fresino V007  
Cutter V007  
Fräser V007  
Fraise V007  
Fresa V007  
OPTIONAL

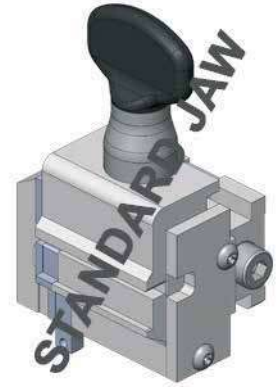

TO FIT: UNION (GB)



**303/304/305**



**T-REX  
T-REX ADVANCE**



**PUNTO**

OPTIONAL

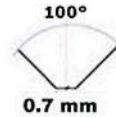

**RIC01789B**  
Fresino HB042  
Cutter HB042  
Fräser HB042  
Fraise HB042  
Fresa HB042



**RIC01790B**  
Tastatore B042  
Tracer Point B042  
Taster B042  
Palpeur B042  
Palpador B042

TO  
FIT :

UNION (GB)

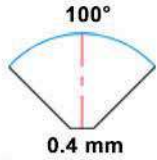

**RIC05264B**  
 Fresino V007  
 Cutter V007  
 Fräser V007  
 Fraise V007  
 Fresa V007  
 OPTIONAL

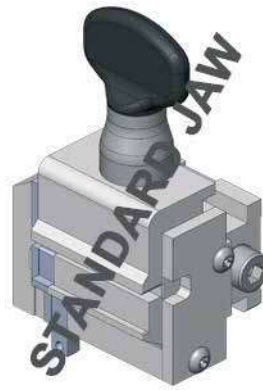

**NINJA TOTAL**



**NINJA VORTEX**



**VERSA**



TO  
FIT :

UNION (GB)

OPTIONAL

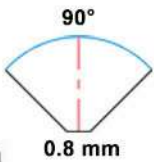

**RIC06368B**  
 Fresino V022  
 Cutter V022  
 Fräser V022  
 Fraise V022  
 Fresa V022

**OPZ10427B**  
 Morsetto C39  
 Jaw C39  
 Spannbacke C39  
 Étau C39  
 Mordaza C39



**NINJA TOTAL**



**NINJA VORTEX**



**VERSA**



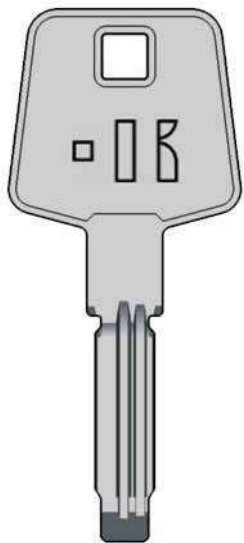

VC20



VC15



**304/305**



**T-REX  
T-REX ADVANCE**

**STANDARD**

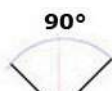

90°

0.45 mm

**RIC01793B**  
Fresino HB020  
Cutter HB020  
Fräser HB020  
Fraise HB020  
Fresa HB020



**RIC01794B**  
Tastatore B020  
Tracer Point B020  
Taster B020  
Palpeur B020  
Palpador B020

**OPTIONAL**

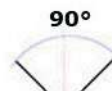

90°

1.0 mm

**RIC01822B**  
Fresino HB043  
Cutter HB043  
Fräser HB043  
Fraise HB043  
Fresa HB043



**RIC01823B**  
Tastatore B043  
Tracer Point B043  
Taster B043  
Palpeur B043  
Palpador B043



**NINJA TOTAL**



**NINJA VORTEX**



**VERSA**



90°

0.4 mm

**RIC05044B**  
Fresino V001  
Cutter V001  
Fräser V001  
Fraise V001  
Fresa V001



**STANDARD**

OR



90°

0.7 mm

**RIC05618B**  
Fresino V013  
Cutter V013  
Fräser V013  
Fraise V013  
Fresa V013



**OPTIONAL**

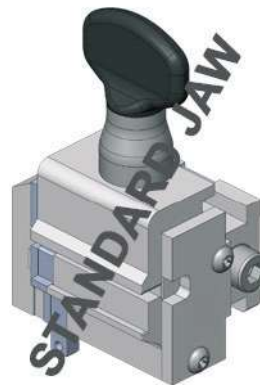

TO  
FIT :

VACHETTE (F)

OPTIONAL



**RIC06368B**  
Fresino V022  
Cutter V022  
Fräser V022  
Fraise V022  
Fresa V022

**OPZ10427B**  
Morsetto C39  
Jaw C39  
Spannbacke C39  
Étau C39  
Mordaza C39



**NINJA TOTAL**



**NINJA VORTEX**



**VERSA**

**Vercy**



TO  
FIT :

VIRO (I)

STANDARD



**RIC01793B**  
Fresino HB020  
Cutter HB020  
Fräser HB020  
Fraise HB020  
Fresa HB020



**RIC01794B**  
Tastatore B020  
Tracer Point B020  
Taster B020  
Palpeur B020  
Palpador B020



**303/304/305**



**T-REX  
T-REX ADVANCE**



**PUNTO**

**EURO-PRO**

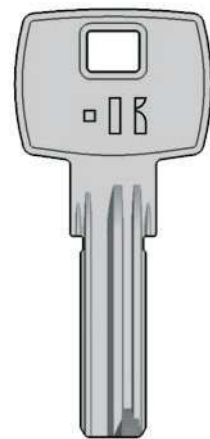

**VR19**

OPTIONAL

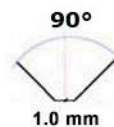

**RIC01822B**  
Fresino HB043  
Cutter HB043  
Fräser HB043  
Fraise HB043  
Fresa HB043



**RIC01823B**  
Tastatore B043  
Tracer Point B043  
Taster B043  
Palpeur B043  
Palpador B043



TO FIT: VIRO (I)

EURO-PRO

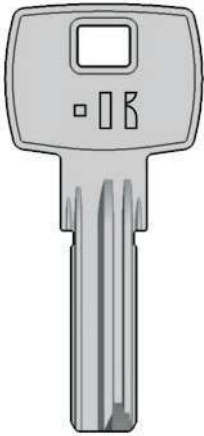

VR19



NINJA TOTAL



NINJA VORTEX



VERSA

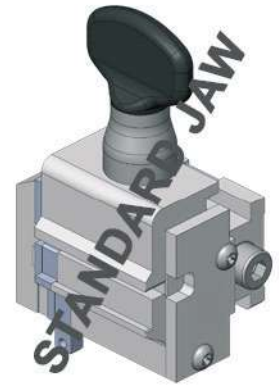
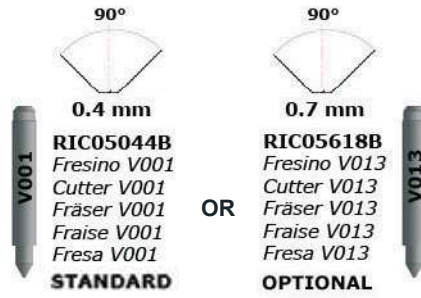

TO FIT: VIRO (I)

PALLADIUM

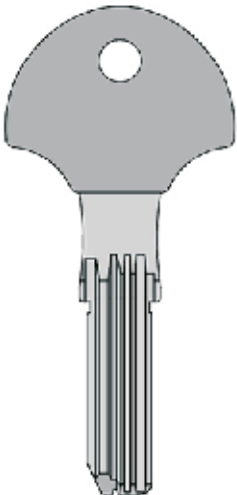

303/304/305



T-REX  
T-REX ADVANCE



PUNTO

OPTIONAL



RIC01786B  
Tastatore B039  
Tracer Point B039  
Taster B039  
Palpeur B039  
Palpador B039

TO  
FIT :

VIRO (I)

OPTIONAL

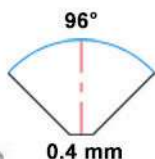

**RIC05262B**  
Fresino V006  
Cutter V006  
Fräser V006  
Fraise V006  
Fresa V006

**OPZ08363B**  
Morsetto C20  
Jaw C20  
Spannbacke C20  
Étau C20  
Mordaza C20



**NINJA TOTAL**



**NINJA VORTEX**



**VERSA**

**PALLADIUM**

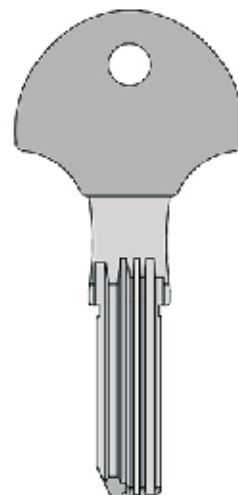

TO  
FIT :

WEST (J)

OPTIONAL

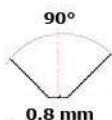

**RIC01781B**  
Fresino HB015  
Cutter HB015  
Fräser HB015  
Fraise HB015  
Fresa HB015

**RIC01782B**  
Tastatore B015  
Tracer Point B015  
Taster B015  
Palpeur B015  
Palpador B015

**303/304/305**



**T-REX  
T-REX ADVANCE**



**PUNTO**



STANDARD

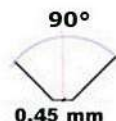

**RIC01793B**  
Fresino HB020  
Cutter HB020  
Fräser HB020  
Fraise HB020  
Fresa HB020

**RIC01794B**  
Tastatore B020  
Tracer Point B020  
Taster B020  
Palpeur B020  
Palpador B020

TO FIT: WEST (J)



**NINJA TOTAL**



**NINJA VORTEX**



**VERSA**

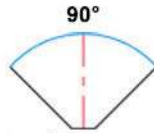

0.4 mm



**RIC05044B**  
Fresino V001  
Cutter V001  
Fräser V001  
Fraise V001  
Fresa V001  
**STANDARD**

**OPZ07800B**  
Morsetto C15  
Jaw C15  
Spannbacke C15  
Étau C15  
Mordaza C15  
**OPTIONAL**



TO FIT: WILKA (D)

P3/PR300

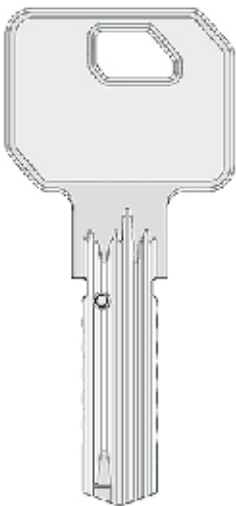

**NINJA TOTAL**



**NINJA VORTEX**



**VERSA**

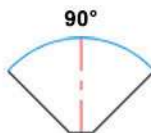

0.4 mm



**RIC05044B**  
Fresino V001  
Cutter V001  
Fräser V001  
Fraise V001  
Fresa V001  
**STANDARD**

**OPZ08375B**  
Morsetto C19  
Jaw C19  
Spannbacke C19  
Étau C19  
Mordaza C19  
**OPTIONAL**

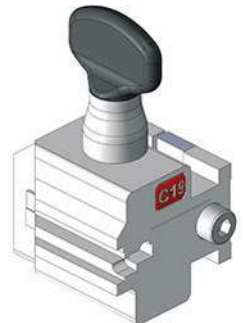

**OPTIONAL**

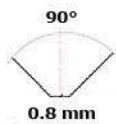

**RIC01781B**  
Fresino HB015  
Cutter HB015  
Fräser HB015  
Fraise HB015  
Fresa HB015



**RIC01782B**  
Tastatore B015  
Tracer Point B015  
Taster B015  
Palpeur B015  
Palpador B015

**STANDARD**

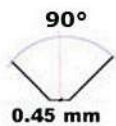

**RIC01793B**  
Fresino HB020  
Cutter HB020  
Fräser HB020  
Fraise HB020  
Fresa HB020



**RIC01794B**  
Tastatore B020  
Tracer Point B020  
Taster B020  
Palpeur B020  
Palpador B020



**303/304/305**



**T-REX  
T-REX ADVANCE**



**PUNTO**

W3600



W3600

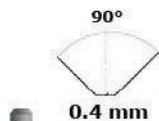

**V001**  
**RIC05044B**  
Fresino V001  
Cutter V001  
Fräser V001  
Fraise V001  
Fresa V001  
**STANDARD**

OR

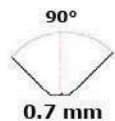

**V013**  
**RIC05618B**  
Fresino V013  
Cutter V013  
Fräser V013  
Fraise V013  
Fresa V013  
**OPTIONAL**

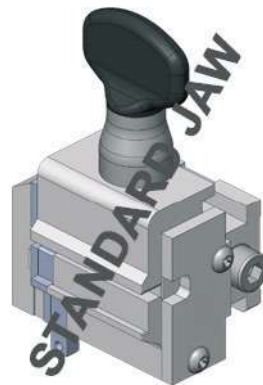

**NINJA TOTAL**



**NINJA VORTEX**



**VERSA**



TO FIT: **WILKA (D)**

**PR100-CARAT**

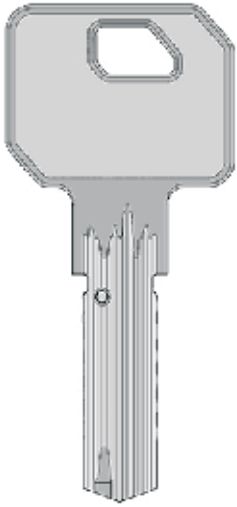

**WPL**



**NINJA TOTAL**



**NINJA VORTEX**



**VERSA**

**OPTIONAL**

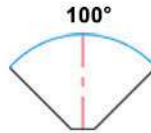

**0.4 mm**

**RIC05264B**  
*Fresino V007*  
*Cutter V007*  
*Fräser V007*  
*Fraise V007*  
*Fresa V007*



**OPZ06039B**

*Morsetto C08*  
*Jaw C08*  
*Spannbacke C08*  
*Étau C08*  
*Mordaza C08*



TO FIT: **WINKHAUS (D)**

**X-TRA**

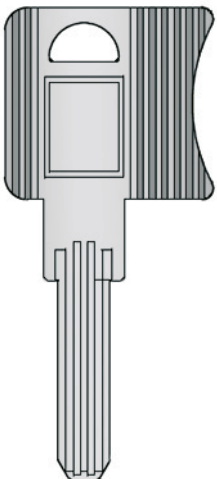

**WPL**



**303/304/305**



**T-REX**  
**T-REX ADVANCE**



**PUNTO**

**STANDARD**

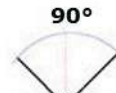

**0.45 mm**

**RIC01793B**  
*Fresino HB020*  
*Cutter HB020*  
*Fräser HB020*  
*Fraise HB020*  
*Fresa HB020*



**RIC01794B**  
*Tastatore B020*  
*Tracer Point B020*  
*Taster B020*  
*Palpeur B020*  
*Palpador B020*

TO  
FIT :

WINKHAUS (D)



OR

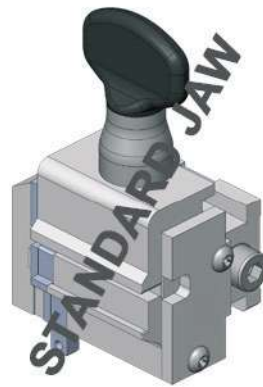

**NINJA TOTAL**



**NINJA VORTEX**



**VERSA**

X-TRA

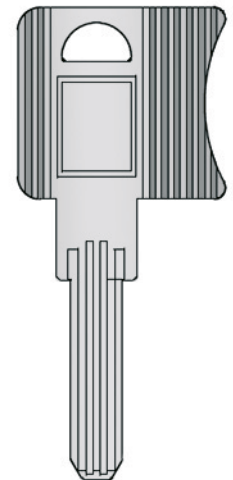

TO  
FIT :

WINKHAUS (D)

**OPTIONAL**

**OPZ09531B**  
Morsetto N25  
Jaw N25  
Spannbacke N25  
Étau N25  
Mordaza N25

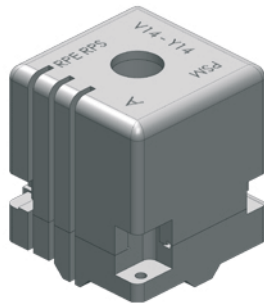

**NINJA LASER**



**NINJA TOTAL**

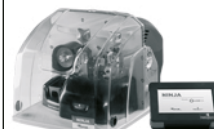

**NINJA  
NINJA DARK**

RPE-RPS

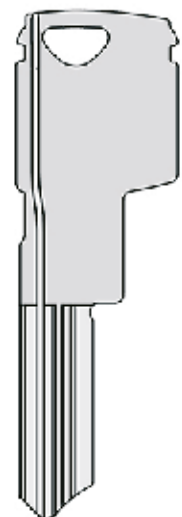

RPE-RPS

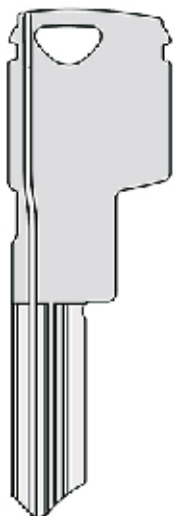

NINJA VORTEX



VERSA



NINJA TOTAL



NINJA VORTEX



VERSA

FOR EDGE CUT

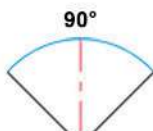

0.4 mm

**RIC05044B**

Fresino V001  
Cutter V001  
Fräser V001  
Fraise V001  
Fresa V001

**STANDARD**



**OPZ010307B**

Morsetto C35  
Jaw C35  
Spannbacke C35  
Étau C35  
Mordaza C35  
**OPTIONAL**



OPTIONAL

FOR DIMPLE CUT

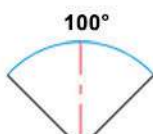

0.4 mm

**RIC05264B**

Fresino V007  
Cutter V007  
Fräser V007  
Fraise V007  
Fresa V007



**OPZ010307B**

Morsetto C35  
Jaw C35  
Spannbacke C35  
Étau C35  
Mordaza C35



TO  
FIT :

WINKHAUS (D)

OPTIONAL

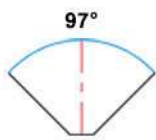

0.60 mm



**RIC010290B**  
Fresino V047  
Cutter V047  
Fräser V047  
Fraise V047  
Fresa V047

**OPZ10287B**  
Morsetto C32  
Jaw C32  
Spannbacke C32  
Étau C32  
Mordaza C32



**NINJA TOTAL**



**NINJA VORTEX**



**VERSA**

ON-TRA

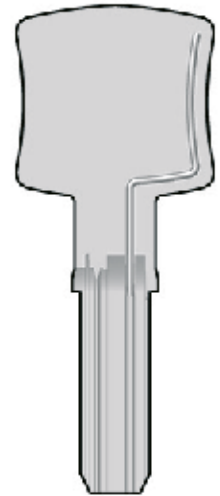

TO  
FIT :

WINKHAUS (D)

OPTIONAL

**OPZ09531B**  
Morsetto N25  
Jaw N25  
Spannbacke N25  
Étau N25  
Mordaza N25



**NINJA LASER**



**NINJA TOTAL**



**NINJA  
NINJA DARK**

AZ VS  
RPE-RPS

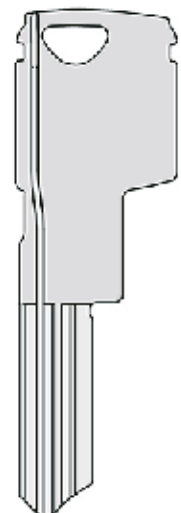



TO FIT: YALE (GB)

MARTE

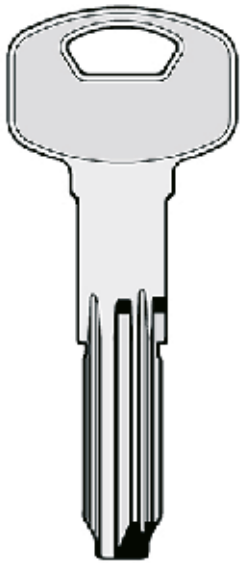

NINJA TOTAL



NINJA VORTEX



VERSA

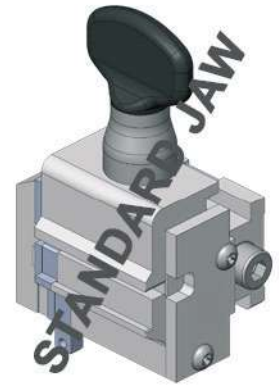
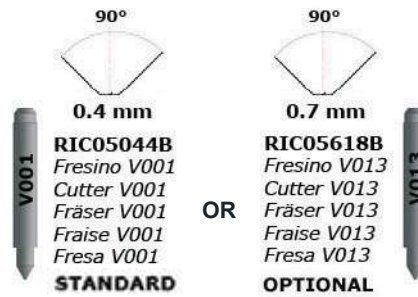

TO FIT: YALE (GB)

230

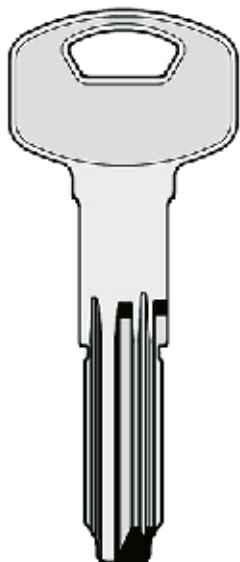

303/304/305



T-REX  
T-REX ADVANCE



PUNTO

OPTIONAL

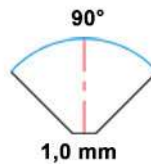

RIC01822B  
Fresino HB043  
Cutter HB043  
Fräser HB043  
Fraise HB043  
Fresa HB043



RIC01823B  
Tastatore B043  
Tracer Point B043  
Taster B043  
Palpeur B043  
Palpador B043

**STANDARD**

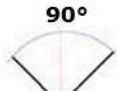

0.45 mm

**RIC01793B**  
Fresino HB020  
Cutter HB020  
Fräser HB020  
Fraise HB020  
Fresa HB020



**RIC01794B**  
Tastatore B020  
Tracer Point B020  
Taster B020  
Palpeur B020  
Palpador B020



**303/304/305**



**T-REX  
T-REX ADVANCE**



**PUNTO**



YY3P



YY5P



0.4 mm



**RIC05264B**  
Fresino V007  
Cutter V007  
Fräser V007  
Fraise V007  
Fresa V007  
OPTIONAL

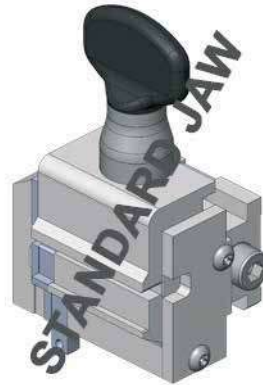

**NINJA TOTAL**



**NINJA VORTEX**



**VERSA**

XL

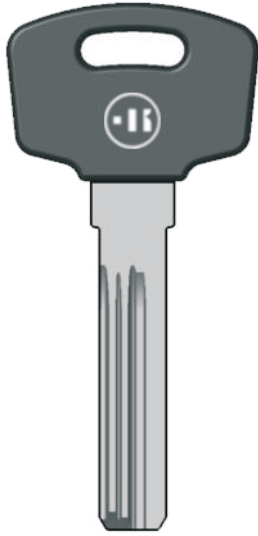

  
YY13P



**303/304/305**



**T-REX  
T-REX ADVANCE**



**PUNTO**



**NINJA TOTAL**



**NINJA VORTEX**



**VERSA**

**OPTIONAL**

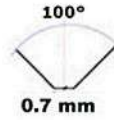

**0.7 mm**

**RIC01789B**  
*Fresino HB042  
Cutter HB042  
Fräser HB042  
Fraise HB042  
Fresa HB042*



**RIC01790B**  
*Tastatore B042  
Tracer Point B042  
Taster B042  
Palpeur B042  
Palpador B042*

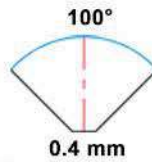

**0.4 mm**



**RIC05264B**  
*Fresino V007  
Cutter V007  
Fräser V007  
Fraise V007  
Fresa V007*  
**OPTIONAL**

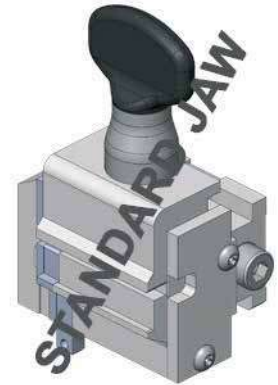

TO  
FIT :

ZADI (I)

OPTIONAL

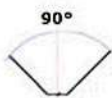

0.9 mm

**RIC01775B**

*Fresino HB005  
Cutter HB005  
Fräser HB005  
Fraise HB005  
Fresa HB005*



**RIC01776B**

*Tastatore B005  
Tracer Point B005  
Taster B005  
Palpeur B005  
Palpador B005*



**303/304/305**



**T-REX  
T-REX ADVANCE**



**PUNTO**

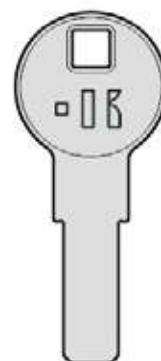

**ZAD26**

TO  
FIT :

ZADI (I)

OPTIONAL



2 mm

**RIC01816B**

*Fresino HC044  
Cutter HC044  
Fräser HC044  
Fraise HC044  
Fresa HC044*



**RIC01817B**

*Tastatore C044  
Tracer Point C044  
Taster C044  
Palpeur C044  
Palpador C044*



**303/304/305**



**T-REX  
T-REX ADVANCE**



**PUNTO**

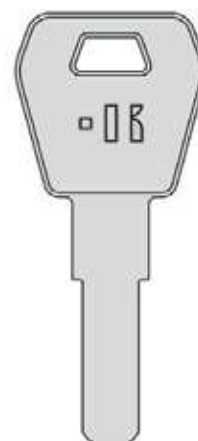

**ZAD25**



TO FIT: ZEISS IKON (D)

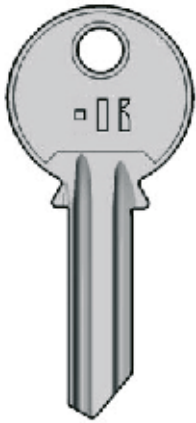

ZI2 ZI2S



**NINJA VORTEX**



**VERSA**

OPTIONAL

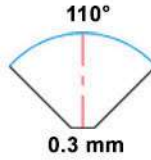

**RIC05270B**  
Fresino V010  
Cutter V010  
Fräser V010  
Fraise V010  
Fresa V010

**OPZ06039B**  
Morsetto C08  
Jaw C08  
Spannbacke C08  
Étau C08  
Mordaza C08



TO FIT: ZEISS IKON (D)

**RW6**



**NINJA TOTAL**



**NINJA VORTEX**



**VERSA**

OPTIONAL

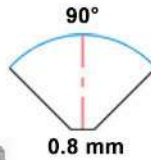

**RIC06368B**  
Fresino V022  
Cutter V022  
Fräser V022  
Fraise V022  
Fresa V022

**OPZ10427B**  
Morsetto C39  
Jaw C39  
Spannbacke C39  
Étau C39  
Mordaza C39



**CHIAVI AUTO / CHIAVI CAMION / ACCESSORI**

---

**CAR KEYS / TRUCK KEYS / ACCESSORIES**

---

**AUTOSCHLÜSSEL / LKW-SCHLÜSSEL / ZUBEHÖR**

---

**CLÉS AUTO / CLÉS CAMION / ACCESSOIRES**

---

**LLAVES PARA AUTO / LLAVES PARA CAMIONES / ACCESORIOS**

---



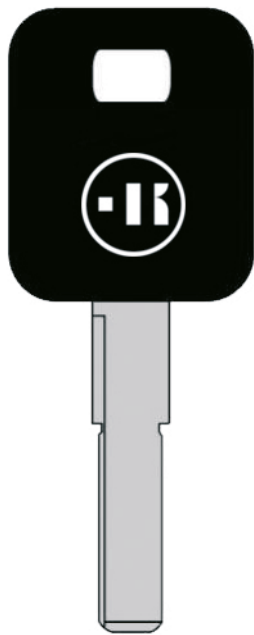

AD66TK1

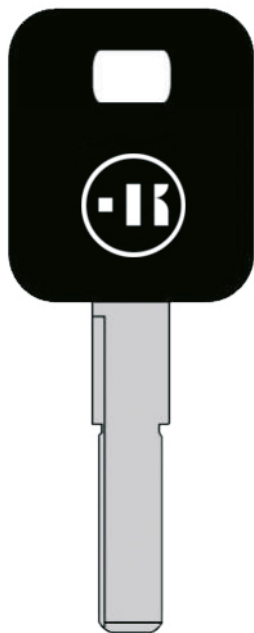

AD66TK8



303/304/305



PUNTO



T-REX  
T-REX ADVANCE

OPTIONAL

MA

Adattatori per chiavi VAG  
Adaptors for VAG keys  
Adapters für VAG-Schlüssel  
Adaptateurs pour clés VAG  
Adaptadores para llaves VAG



STANDARD



2.5 mm

**RIC01810B**  
Fresino HC011  
Cutter HC011  
Fräser HC011  
Fraise HC011  
Fresa HC011



**RIC01811B**  
Tastatore C011  
Tracer Point C011  
Taster C011  
Palpeur C011  
Palpador C011

OPTIONAL



3.0 mm

**RIC01715B**  
Fresino HC030  
Cutter HC030  
Fräser HC030  
Fraise HC030  
Fresa HC030



**RIC01716B**  
Tastatore C030  
Tracer Point C030  
Taster C030  
Palpeur C030  
Palpador C030

STANDARD



2,5 mm

**RIC01810B**  
Fresino HC011  
Cutter HC011  
Fräser HC011  
Fraise HC011  
Fresa HC011



**RIC01811B**  
Tastatore C011  
Tracer Point C011  
Taster C011  
Palpeur C011  
Palpador C011

OPTIONAL



3,0 mm

**RIC01715B**  
Fresino HC030  
Cutter HC030  
Fräser HC030  
Fraise HC030  
Fresa HC030



**RIC01716B**  
Tastatore C030  
Tracer Point C030  
Taster C030  
Palpeur C030  
Palpador C030

STANDARD

**OPZ05223B**

Morsetto C-994  
Jaw C-994  
Spannbacke C-994  
Étau C-994  
Mordaza C-994

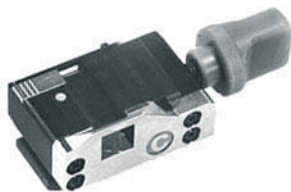

**994 LASER**



2.5 mm



**RIC05304B**

Fresino WC011A  
Cutter WC011A  
Fräser WC011A  
Fraise WC011A  
Fresa WC011A

STANDARD

**OPZ09734B**

Morsetto A/C - 997  
Jaw A/C - 997  
Spannbacke A/C - 997  
Étau A/C - 997  
Mordaza A/C - 997

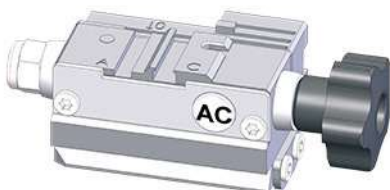

**NINJA LASER**

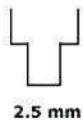

2.5 mm



**RIC05304B**

Fresino WC011A  
Cutter WC011A  
Fräser WC011A  
Fraise WC011A  
Fresa WC011A

STANDARD  
(VERSION 4 JAWS)



2.5 mm



**RIC05048B**

Fresino V003  
Cutter V003  
Fräser V003  
Fraise V003  
Fresa V003

**OPZ04875B**

Morsetto A03  
Jaw A03  
Spannbacke A03  
Étau A03  
Mordaza A03

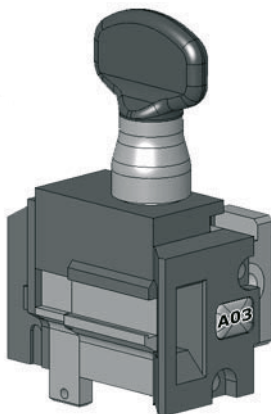

**NINJA TOTAL**



**NINJA VORTEX**



**VERSA**

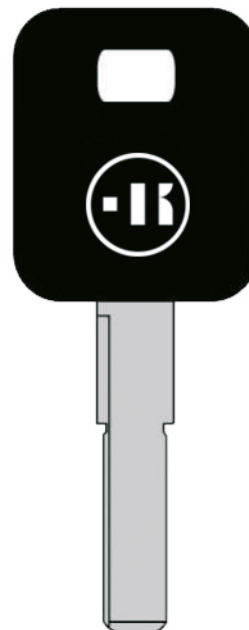

**AD66TK1**

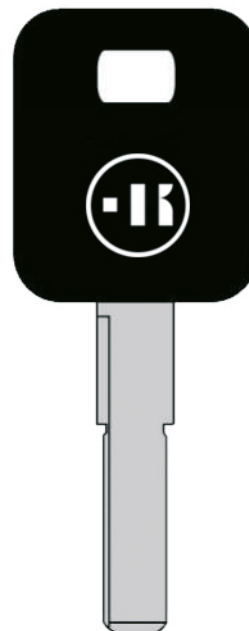

**AD66TK8**



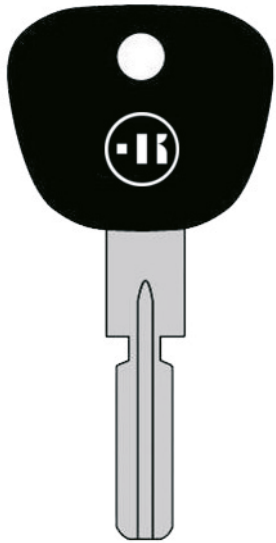

**HU58P**



**STANDARD**



**RIC01810B**  
Fresino HC011  
Cutter HC011  
Fräser HC011  
Fraise HC011  
Fresa HC011



**RIC01811B**  
Tastatore C011  
Tracer Point C011  
Taster C011  
Palpeur C011  
Palpador C011



**STANDARD**

**OPZ03183B**  
Morsetto B-994  
Jaw B-994  
Spannbacke B-994  
Étau B-994  
Mordaza B-994



**RIC05304B**  
Fresino WC011A  
Cutter WC011A  
Fräser WC011A  
Fraise WC011A  
Fresa WC011A



**STANDARD**

**OPZ09781B**  
Morsetto B - 997  
Jaw B - 997  
Spannbacke B - 997  
Étau B - 997  
Mordaza B - 997

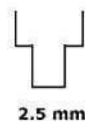

**RIC05304B**  
Fresino WC011A  
Cutter WC011A  
Fräser WC011A  
Fraise WC011A  
Fresa WC011A

**STANDARD**  
(VERSION 4 JAWS)



2.5 mm



**RIC05048B**  
Fresino V003  
Cutter V003  
Fräser V003  
Fraise V003  
Fresa V003

**OPZ04873B**  
Morsetto A02  
Jaw A02  
Spannbacke A02  
Étau A02  
Mordaza A02

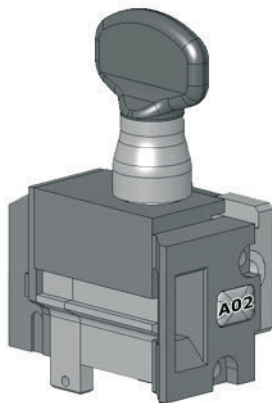

**NINJA TOTAL**



**NINJA VORTEX**



**VERSA**

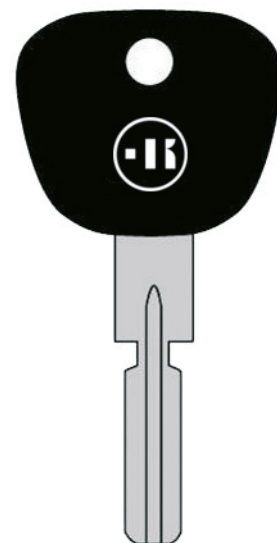

HU58P



BM9U



**OPTIONAL**



2 mm

**RIC01816B**  
Fresino HC044  
Cutter HC044  
Fräser HC044  
Fraise HC044  
Fresa HC044



**RIC01817B**  
Tastatore C044  
Tracer Point C044  
Taster C044  
Palpeur C044  
Palpador C044



**OPZ09329B**  
Adattatore AV08  
Adaptor AV08  
Adapter AV08  
Adaptateur AV08  
Adaptador AV08  
**OPTIONAL**

**OPZ03182B**  
Morsetto A-994  
Jaw A-994  
Spannbacke A-994  
Étau A-994  
Mordaza A-994  
**STANDARD**

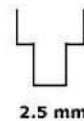

2.5 mm

**RIC05304B**  
Fresino WC011A  
Cutter WC011A  
Fräser WC011A  
Fraise WC011A  
Fresa WC011A  
**STANDARD**



**OPZ09329B**  
Adattatore AV08  
Adaptor AV08  
Adapter AV08  
Adaptateur AV08  
Adaptador AV08  
**OPTIONAL**

**OPZ09734B**  
Morsetto A/C - 997  
Jaw A/C - 997  
Spannbacke A/C - 997  
Étau A/C - 997  
Mordaza A/C - 997  
**STANDARD**

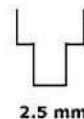
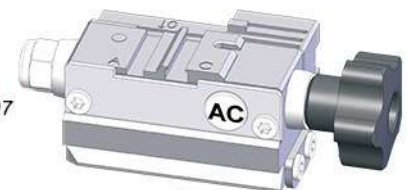

2.5 mm

**RIC05304B**  
Fresino WC011A  
Cutter WC011A  
Fräser WC011A  
Fraise WC011A  
Fresa WC011A  
**STANDARD**





**OPZ09329B**  
Adattatore AV08  
Adaptor AV08  
Adapter AV08  
Adaptateur AV08  
Adaptador AV08  
**OPTIONAL**



**OPZ04871B**  
Morsetto A01  
Jaw A01  
Spannbacke A01  
Étau A01  
Mordaza A01  
**STANDARD**  
(VERSION 4 JAWS)

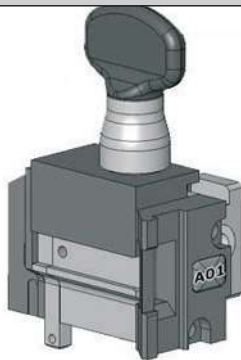

**NINJA VORTEX**



**VERSA**



**OPZ09329B**  
Adattatore AV08  
Adaptor AV08  
Adapter AV08  
Adaptateur AV08  
Adaptador AV08  
**OPTIONAL**



**OPZ10569B**  
Morsetto C30  
Jaw C30  
Spannbacke C30  
Étau C30  
Mordaza C30  
**STANDARD**



**NINJA TOTAL**

**BM9U**





**BM2TK**



**303/304/305**

**T-REX  
T-REX ADVANCE**

**PUNTO**



**994 LASER**



**NINJA LASER**

**OPTIONAL**



**3,0 mm**

**RIC01715B**  
Fresino HC030  
Cutter HC030  
Fräser HC030  
Fraise HC030  
Fresa HC030



**RIC01716B**  
Tastatore C030  
Tracer Point C030  
Taster C030  
Palpeur C030  
Palpador C030

**STANDARD**

**OPZ05223B**  
Morsetto C-994  
Jaw C-994  
Spannbacke C-994  
Étau C-994  
Mordaza C-994



**2.5 mm**



**RIC05304B**  
Fresino WC011A  
Cutter WC011A  
Fräser WC011A  
Fraise WC011A  
Fresa WC011A

**STANDARD**

**OPZ09734B**  
Morsetto A/C - 997  
Jaw A/C - 997  
Spannbacke A/C - 997  
Étau A/C - 997  
Mordaza A/C - 997

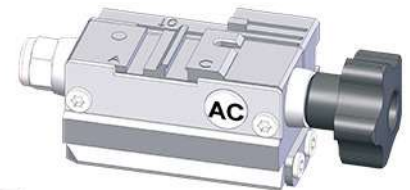

**2.5 mm**



**RIC05304B**  
Fresino WC011A  
Cutter WC011A  
Fräser WC011A  
Fraise WC011A  
Fresa WC011A

**STANDARD**  
(VERSION 4 JAWS)



2.5 mm



**RIC05048B**  
Fresino V003  
Cutter V003  
Fräser V003  
Fraise V003  
Fresa V003

**OPZ04875B**  
Morsetto A03  
Jaw A03  
Spannbacke A03  
Étau A03  
Mordaza A03

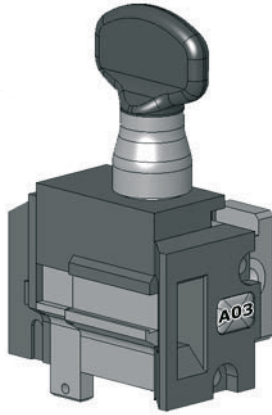

**NINJA TOTAL**



**NINJA VORTEX**



**VERSA**



  
**BM2TK**



**CARAT/106**



**101/102  
103/104**



**EURO/ECO  
EASY/LUPO**

**OPTIONAL**

**MC**

*Adattatori per chiavi Simplex  
Adaptors for Simplex keys  
Adapters für Simplex-Schlüssel  
Adaptateurs pour clés Simplex  
Adaptadores para llaves Simplex*



**994 LASER**

**OPTIONAL**

**OPZ09733B**

*Morsetto S per chiavi Simplex  
Jaw S for Simplex keys  
Spannbacke S für Simplex-Schlüssel  
Étau S pour clés Simplex  
Mordaza S para llaves Simplex*

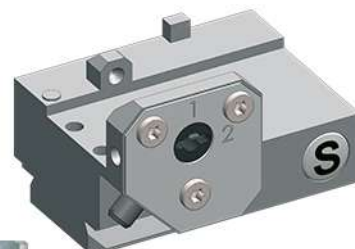

**RIC08409B**

*Fresino CL004  
Cutter CL004  
Fräser CL004  
Fraise CL004  
Fresa CL004*



**1,5 mm**



**INCLUDED WITH JAW**

*Tastatore TL002  
Tracer Point TL002  
Taster TL002  
Palpeur TL002  
Palpador TL002*



**CN22AP  
CN22CP  
CN22U  
CN22TK1  
CN22TK8**

**OPTIONAL**



**OPZ08264B**  
*Adattatore B6 per chiavi Simplex*  
*Adaptor B6 sides for Simplex keys*  
*Adapter B6 für Simplex Schlüssel*  
*Adaptateur B6 pour clés Simplex*  
*Adaptador B6 para llaves Simplex*



**DEZMO**



**NINJA LASER**



**NINJA TOTAL**



**CN22AP**  
**CN22CP**  
**CN22U**  
**CN22TK1**  
**CN22TK8**





FT22TK



303/304/305



T-REX  
T-REX ADVANCE



PUNTO



994 LASER



NINJA LASER

OPTIONAL



2 mm

**RIC01816B**  
Fresino HC044  
Cutter HC044  
Fräser HC044  
Fraise HC044  
Fresa HC044



**RIC01817B**  
Tastatore C044  
Tracer Point C044  
Taster C044  
Palpeur C044  
Palpador C044

STANDARD

**OPZ05223B**  
Morsetto C-994  
Jaw C-994  
Spannbacke C-994  
Étau C-994  
Mordaza C-994



2.5 mm



**RIC05304B**  
Fresino WC011A  
Cutter WC011A  
Fräser WC011A  
Fraise WC011A  
Fresa WC011A

STANDARD

**OPZ09734B**  
Morsetto A/C - 997  
Jaw A/C - 997  
Spannbacke A/C - 997  
Étau A/C - 997  
Mordaza A/C - 997

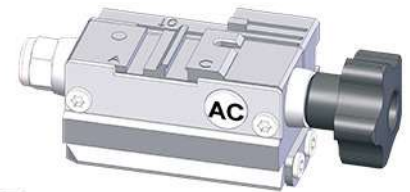

2.5 mm



**RIC05304B**  
Fresino WC011A  
Cutter WC011A  
Fräser WC011A  
Fraise WC011A  
Fresa WC011A

**STANDARD**  
(VERSION 4 JAWS)



2.5 mm



**RIC05048B**  
Fresino V003  
Cutter V003  
Fräser V003  
Fraise V003  
Fresa V003

**OPZ04875B**  
Morsetto A03  
Jaw A03  
Spannbacke A03  
Étau A03  
Mordaza A03

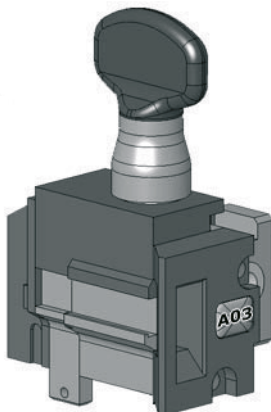

**NINJA TOTAL**



**NINJA VORTEX**



**VERSA**



FT22TK



**CARAT/106**



**101/102  
103/104**



**EURO/ECO  
EASY/LUPO**

**OPTIONAL**

**MC**

*Adattatori per chiavi Simplex  
Adaptors for Simplex keys  
Adapters für Simplex-Schlüssel  
Adaptateurs pour clés Simplex  
Adaptadores para llaves Simplex*



**994 LASER**

**OPTIONAL**

**OPZ09733B**

*Morsetto S per chiavi Simplex  
Jaw S for Simplex keys  
Spannbacke S für Simplex-Schlüssel  
Étau S pour clés Simplex  
Mordaza S para llaves Simplex*

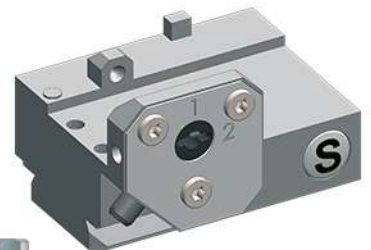

**RIC08409B**

*Fresino CL004  
Cutter CL004  
Fräser CL004  
Fraise CL004  
Fresa CL004*

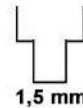

**1,5 mm**



**INCLUDED WITH JAW**

*Tastatore TL002  
Tracer Point TL002  
Taster TL002  
Palpeur TL002  
Palpador TL002*



**CN22AP  
CN22CP  
CN22U  
CN22TK1  
CN22TK8**

**OPTIONAL**



**OPZ08264B**  
*Adattatore B6 per chiavi Simplex*  
*Adaptor B6 sides for Simplex keys*  
*Adapter B6 für Simplex Schlüssel*  
*Adaptateur B6 pour clés Simplex*  
*Adaptador B6 para llaves Simplex*



**DEZMO**



**NINJA LASER**



**NINJA TOTAL**



**CN22AP**  
**CN22CP**  
**CN22U**  
**CN22TK1**  
**CN22TK8**



TO FIT: FORD (EU)

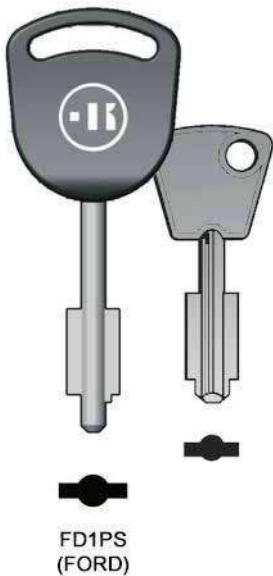

OPTIONAL

**OPZ06365B**  
 Morsetti per chiavi CHUBB  
 Jaws for CHUBB keys  
 Spannbacken für CHUBB  
 Étaux pour clés CHUBB  
 Mordazas para CHUBB

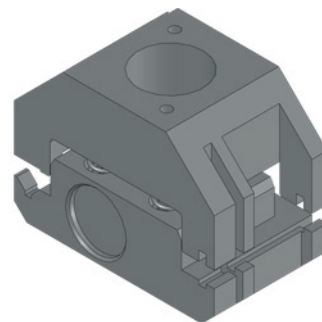

TO FIT: FORD (EU)

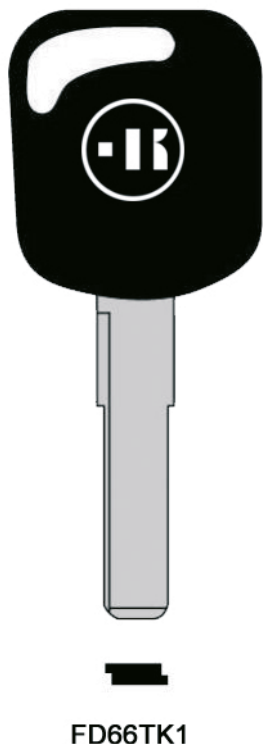

OPTIONAL

**MA**  
 Adattatori per chiavi VAG  
 Adaptors for VAG keys  
 Adapter für VAG-Schlüssel  
 Adaptateurs pour clés VAG  
 Adaptadores para llaves VAG

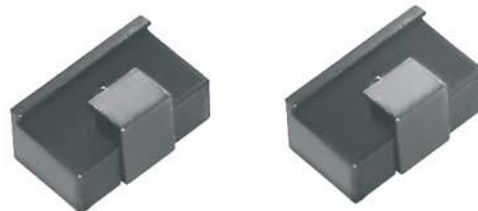

STANDARD



**RIC01810B**  
 Fresino HC011  
 Cutter HC011  
 Fräser HC011  
 Fraise HC011  
 Fresa HC011



**RIC01811B**  
 Tastatore C011  
 Tracer Point C011  
 Taster C011  
 Palpeur C011  
 Palpador C011

OPTIONAL

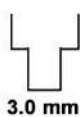

**RIC01715B**  
 Fresino HC030  
 Cutter HC030  
 Fräser HC030  
 Fraise HC030  
 Fresa HC030



**RIC01716B**  
 Tastatore C030  
 Tracer Point C030  
 Taster C030  
 Palpeur C030  
 Palpador C030

**STANDARD**



2,5 mm

**RIC01810B**  
Fresino HC011  
Cutter HC011  
Fräser HC011  
Fraise HC011  
Fresa HC011



**RIC01811B**  
Tastatore C011  
Tracer Point C011  
Taster C011  
Palpeur C011  
Palpador C011



**T-REX  
T-REX ADVANCE**

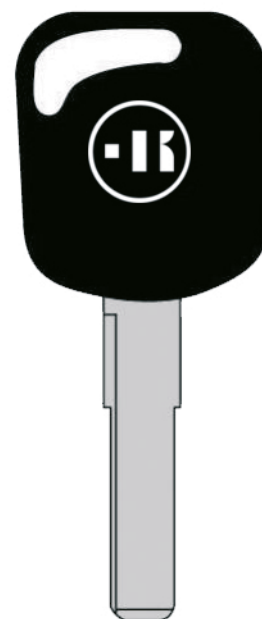

**FD66TK1**

**OPTIONAL**



3,0 mm

**RIC01715B**  
Fresino HC030  
Cutter HC030  
Fräser HC030  
Fraise HC030  
Fresa HC030



**RIC01716B**  
Tastatore C030  
Tracer Point C030  
Taster C030  
Palpeur C030  
Palpador C030

**STANDARD**

**OPZ05223B**  
Morsetto C-994  
Jaw C-994  
Spannbacke C-994  
Étau C-994  
Mordaza C-994



**994 LASER**



2.5 mm



**RIC05304B**  
Fresino WC011A  
Cutter WC011A  
Fräser WC011A  
Fraise WC011A  
Fresa WC011A

**STANDARD**

**OPZ09734B**  
Morsetto A/C - 997  
Jaw A/C - 997  
Spannbacke A/C - 997  
Étau A/C - 997  
Mordaza A/C - 997

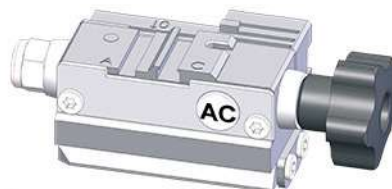

**NINJA LASER**



2.5 mm



**RIC05304B**  
Fresino WC011A  
Cutter WC011A  
Fräser WC011A  
Fraise WC011A  
Fresa WC011A

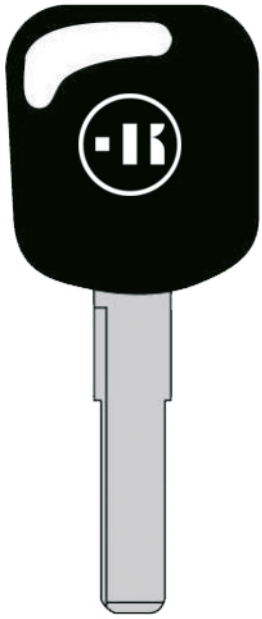

FD66TK1



**NINJA TOTAL**



**NINJA VORTEX**



**VERSA**

**STANDARD**  
(VERSION 4 JAWS)



2.5 mm



**RIC05048B**  
*Fresino V003*  
*Cutter V003*  
*Fräser V003*  
*Fraise V003*  
*Fresa V003*

**OPZ04875B**  
*Morsetto A03*  
*Jaw A03*  
*Spannbacke A03*  
*Étau A03*  
*Mordaza A03*

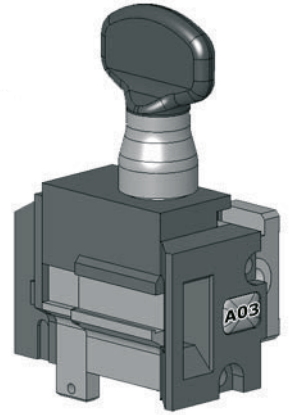

TO  
FIT :

FORD (EU) - FORD (USA)

**OPTIONAL**

**MTB**  
Dispositivo a codice  
Code adaptor  
Code-Vorrichtung  
Dispositif à code  
Dispositivo a código

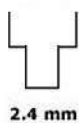

2.4 mm

**RIC01808B**  
Fresino HC208  
Cutter HC208  
Fräser HC208  
Fraise HC208  
Fresa HC208



**RIC01809B**  
Tastatore C208  
Tracer Point C208  
Taster C208  
Palpeur C208  
Palpador C208



**303/304/305**



**T-REX  
T-REX ADVANCE**



**PUNTO**



**OPTIONAL**

**CSR**  
Carrello per chiavi Tibbe  
Carriage for Tibbe keys  
Schlitten für Tibbe-Schlüssel  
Chariot pour clés Tibbe  
Carro las llaves de Tibbe

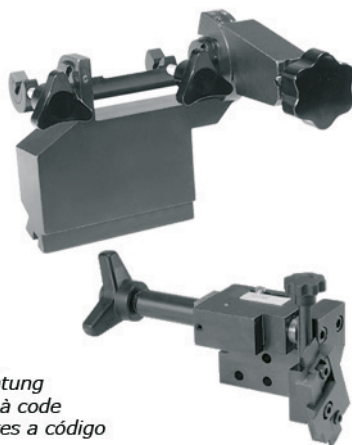

**T3PCOD**  
Tastatore 3 posizioni a codice  
3 position code cutting tracer  
3 Positions-Taster mit Kodevorrichtung  
Palpeur 3 positions avec dispositif à code  
Palpador 3 posiciones para los cortes a código

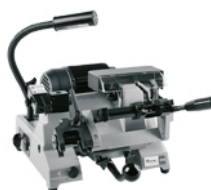

**202**



**203**



**OPTIONAL**

**OPZ05031B**  
Morsetto 05 per chiavi Tibbe  
Jaw 05 for Tibbe keys  
Spannbacke 05 für Tibbe-Schlüssel  
Étau 05 pour clés Tibbe  
Mordaza 05 para llaves Tibbe

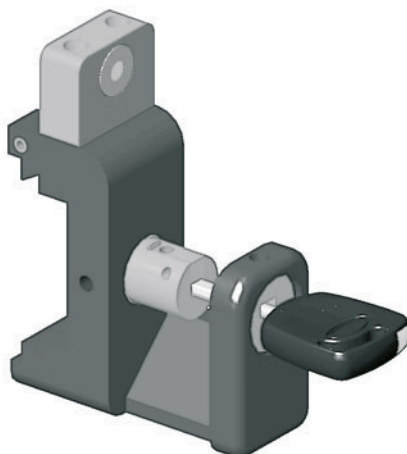

**POWER LYNX  
SIGMA PRO**

**FD3AP  
FD3P  
FD3TK14  
FD3TK23  
FD3TK2  
FD3TK7  
FD3U**





**FALCON**

**OPTIONAL**



**OPZ08657B**  
 Morsetto 01 per chiavi Tibbe  
 Jaw 01 for Tibbe keys  
 Spannbacke 01 für Tibbe Schlüssel  
 Étau 01 pour clés Tibbe  
 Mordaza 01 para llaves Tibbe



**NINJA LASER**

**OPTIONAL**

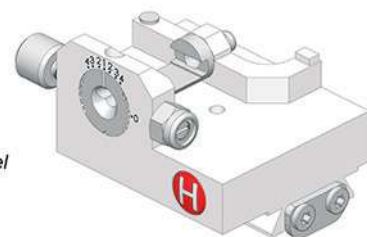

**OPZ09523B**  
 Morsetto H per chiavi Tibbe  
 Jaw H for Tibbe keys  
 Spannbacke H für Tibbe-Schlüssel  
 Étau H pour clés Tibbe  
 Mordaza H para llaves Tibbe



**994 LASER**



**NINJA TOTAL**



**NINJA VORTEX**



**RIC05048B**  
 Fresino V003  
 Cutter V003  
 Fräser V003  
 Fraise V003  
 Fresa V003  
**STANDARD**  
 (VERSION 4 JAWS)

**OPZ10588B**  
 Morsetto C41  
 Jaw C41  
 Spannbacke C41  
 Étau C41  
 Mordaza C41  
**OPTIONAL**



- FD3AP
- FD3P
- FD3TK14
- FD3TK23
- FD3TK2
- FD3TK7
- FD3U



**VERSA**

TO  
FIT :

# FORD (EU) - FORD (USA)

**STANDARD**



**FOCUS**



FD3AP  
FD3P  
FD3TK14  
FD3TK23  
FD3TK2  
FD3TK7  
FD3U



FD40BTK



**303/304/305**  
**T-REX**  
**T-REX ADVANCE**  
**PUNTO**

**OPTIONAL**

**MOMAX**

Adattatori per chiavi Opel e Ford C-MAX  
Adaptors for Opel and Ford C-MAX keys  
Adaptors für Opel und Ford C-MAX-Schlüssel  
Adaptateurs pour clés Opel et Ford C-MAX  
Adaptadores para llaves Opel y Ford C-MAX



**STANDARD**



2,5 mm

**RIC01810B**

Fresino HC011  
Cutter HC011  
Fräser HC011  
Fraise HC011  
Fresa HC011



**RIC01811B**

Tastatore C011  
Tracer Point C011  
Taster C011  
Palpeur C011  
Palpador C011

**OPTIONAL**



3,0 mm

**RIC01715B**

Fresino HC030  
Cutter HC030  
Fräser HC030  
Fraise HC030  
Fresa HC030



**RIC01716B**

Tastatore C030  
Tracer Point C030  
Taster C030  
Palpeur C030  
Palpador C030



FD40AP



**994 LASER**

**STANDARD**

**OPZ03182B**

Morsetto A-994  
Jaw A-994  
Spannbacke A-994  
Étau A-994  
Mordaza A-994

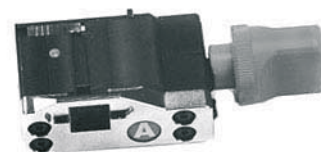

2.5 mm



**RIC05304B**

Fresino WC011A  
Cutter WC011A  
Fräser WC011A  
Fraise WC011A  
Fresa WC011A



**NINJA LASER**

**STANDARD**

**OPZ09734B**

Morsetto A/C - 997  
Jaw A/C - 997  
Spannbacke A/C - 997  
Étau A/C - 997  
Mordaza A/C - 997

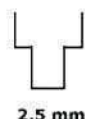
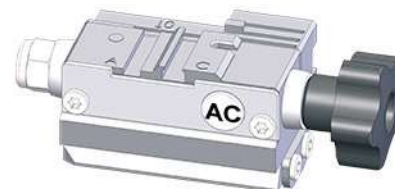

2.5 mm



**RIC05304B**

Fresino WC011A  
Cutter WC011A  
Fräser WC011A  
Fraise WC011A  
Fresa WC011A

**STANDARD**  
(VERSION 4 JAWS)



2.5 mm



**RIC05048B**  
Fresino V003  
Cutter V003  
Fräser V003  
Fraise V003  
Fresa V003

**OPZ04871B**  
Morsetto A01  
Jaw A01  
Spannbacke A01  
Étau A01  
Mordaza A01

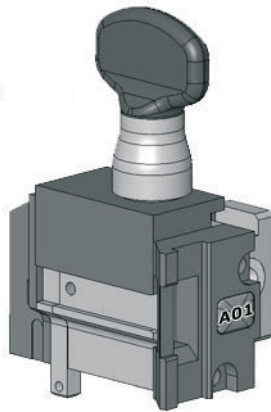

**NINJA VORTEX**



**VERSA**



**FD40BTK**



2.5 mm



**RIC05048B**  
Fresino V003  
Cutter V003  
Fräser V003  
Fraise V003  
Fresa V003  
**STANDARD**

**OPZ10569B**  
Morsetto C30  
Jaw C30  
Spannbacke C30  
Étau C30  
Mordaza C30  
**STANDARD**



**NINJA TOTAL**

**OPZ10582B**  
Adattatore AV12 per chiavi Huf  
Adaptor AV12 for Huf keys  
Adapter AV12 für Huf-Schlüssel  
Adaptateur AV12 pour clés Huf  
Adaptador AV12 para llaves Huf  
**OPTIONAL**



**FD40AP**



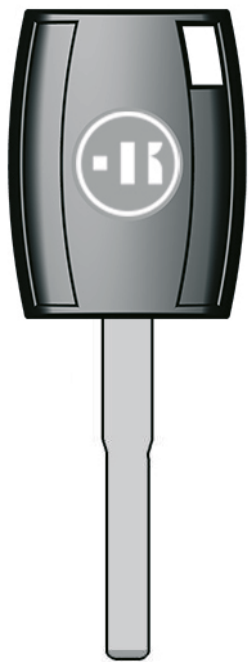

FD40BTK



994 LASER

**OPZ03182B**  
 Morsetto A-994  
 Jaw A-994  
 Spannbacke A-994  
 Étau A-994  
 Mordaza A-994  
**STANDARD**



**RIC09617B**  
 Fresino CL005  
 Cutter CL005  
 Fräser CL005  
 Fraise CL005  
 Fresa CL005  
**OPTIONAL**



1,5 mm



NINJA LASER

**OPZ09734B**  
 Morsetto A/C - 997  
 Jaw A/C - 997  
 Spannbacke A/C - 997  
 Étau A/C - 997  
 Mordaza A/C - 997  
**STANDARD**

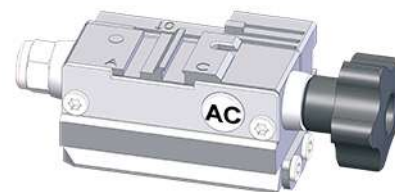

**RIC09617B**  
 Fresino CL005  
 Cutter CL005  
 Fräser CL005  
 Fraise CL005  
 Fresa CL005  
**OPTIONAL**



1,5 mm



FD40AP



NINJA VORTEX



1.5 mm



VERSA



**RIC05274B**  
 Fresino V012  
 Cutter V012  
 Fräser V012  
 Fraise V012  
 Fresa V012  
**OPTIONAL**

**OPZ04871B**  
 Morsetto A01  
 Jaw A01  
 Spannbacke A01  
 Étau A01  
 Mordaza A01  
**STANDARD**  
 (VERSION 4 JAWS)

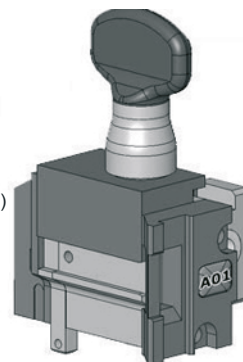

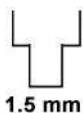

1.5 mm



**RIC05274B**

*Fresino V012  
Cutter V012  
Fräser V012  
Fraise V012  
Fresa V012*

**OPTIONAL**



**OPZ10569B**  
*Morsetto C30  
Jaw C30  
Spannbacke C30  
Étau C30  
Mordaza C30*  
**STANDARD**

**OPZ10582B**

*Adattatore AV12 per chiavi Huf  
Adaptor AV12 for Huf keys  
Adapter AV12 für Huf-Schlüssel  
Adaptateur AV12 pour clés Huf  
Adaptador AV12 para llaves Huf*

**OPTIONAL**



**NINJA TOTAL**



**FD40BTK**



**FD40AP**



**STANDARD**



2,5 mm

**RIC01810B**  
Fresino HC011  
Cutter HC011  
Fräser HC011  
Fraise HC011  
Fresa HC011



**RIC01811B**  
Tastatore C011  
Tracer Point C011  
Taster C011  
Palpeur C011  
Palpador C011

**OPTIONAL**



2,0 mm

**RIC01816B**  
Fresino HC044  
Cutter HC044  
Fräser HC044  
Fraise HC044  
Fresa HC044



**RIC01817B**  
Tastatore C044  
Tracer Point C044  
Taster C044  
Palpeur C044  
Palpador C044



**STANDARD**

**OPZ03182B**  
Morsetto A-994  
Jaw A-994  
Spannbacke A-994  
Étau A-994  
Mordaza A-994

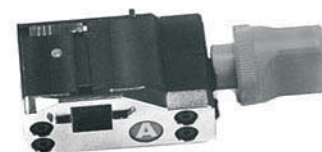

2.5 mm

**OPZ03182B**  
Morsetto A-994  
Jaw A-994  
Spannbacke A-994  
Étau A-994  
Mordaza A-994



**RIC05304B**  
Fresino WC011A  
Cutter WC011A  
Fräser WC011A  
Fraise WC011A  
Fresa WC011A



**STANDARD**

**OPZ09734B**  
Morsetto A/C - 997  
Jaw A/C - 997  
Spannbacke A/C - 997  
Étau A/C - 997  
Mordaza A/C - 997

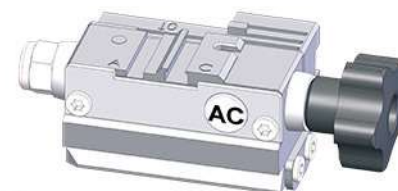

2.5 mm

**OPZ09734B**  
Morsetto A/C - 997  
Jaw A/C - 997  
Spannbacke A/C - 997  
Étau A/C - 997  
Mordaza A/C - 997



**RIC05304B**  
Fresino WC011A  
Cutter WC011A  
Fräser WC011A  
Fraise WC011A  
Fresa WC011A

**STANDARD**  
(VERSION 4 JAWS)



2.5 mm



**RIC05048B**  
Fresino V003  
Cutter V003  
Fräser V003  
Fraise V003  
Fresa V003

**OPZ04875B**  
Morsetto A03  
Jaw A03  
Spannbacke A03  
Étau A03  
Mordaza A03

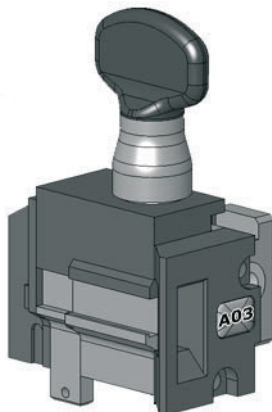

**NINJA TOTAL**



**NINJA VORTEX**



**VERSA**







HD1U



HD1BTK  
HD1TK5



**STANDARD**



2.5 mm

**RIC01810B**  
Fresino HC011  
Cutter HC011  
Fräser HC011  
Fraise HC011  
Fresa HC011



**RIC01811B**  
Tastatore C011  
Tracer Point C011  
Taster C011  
Palpeur C011  
Palpador C011

**STANDARD**

**OPZ03182B**  
Morsetto A-994  
Jaw A-994  
Spannbacke A-994  
Étau A-994  
Mordaza A-994

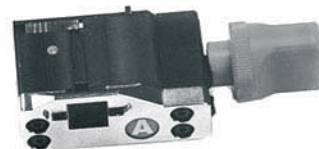

2.5 mm



**RIC05304B**  
Fresino WC011A  
Cutter WC011A  
Fräser WC011A  
Fraise WC011A  
Fresa WC011A

**STANDARD**

**OPZ09734B**  
Morsetto A/C - 997  
Jaw A/C - 997  
Spannbacke A/C - 997  
Étau A/C - 997  
Mordaza A/C - 997

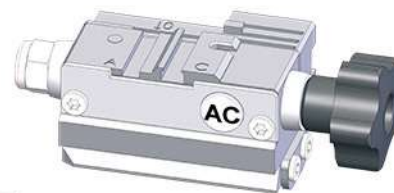

2.5 mm



**RIC05304B**  
Fresino WC011A  
Cutter WC011A  
Fräser WC011A  
Fraise WC011A  
Fresa WC011A

TO  
FIT :

HONDA (J)

**STANDARD**  
(VERSION 4 JAWS)



2.5 mm



**RIC05048B**  
Fresino V003  
Cutter V003  
Fräser V003  
Fraise V003  
Fresa V003

**OPZ04871B**  
Morsetto A01  
Jaw A01  
Spannbacke A01  
Étau A01  
Mordaza A01

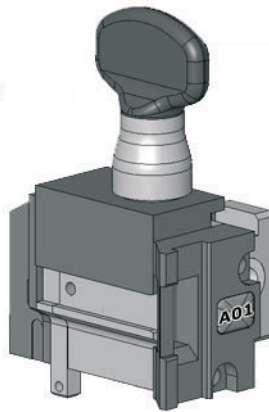

**NINJA VORTEX**



**VERSA**



**HD1U**

**STANDARD**



2.5 mm



**RIC05048B**  
Fresino V003  
Cutter V003  
Fräser V003  
Fraise V003  
Fresa V003

**OPZ10569B**  
Morsetto C30  
Jaw C30  
Spannbacke C30  
Étau C30  
Mordaza C30



**NINJA TOTAL**



**HD1BTK**  
**HD1TK5**



Acura (J)



**OPTIONAL**



2 mm

**RIC01816B**  
Fresino HC044  
Cutter HC044  
Fräser HC044  
Fraise HC044  
Fresa HC044



**RIC01817B**  
Tastatore C044  
Tracer Point C044  
Taster C044  
Palpeur C044  
Palpador C044

**STANDARD**



**OPZ03183B**  
Morsetto B-994  
Jaw B-994  
Spannbacke B-994  
Étau B-994  
Mordaza B-994



2.5 mm



**RIC05304B**  
Fresino WC011A  
Cutter WC011A  
Fräser WC011A  
Fraise WC011A  
Fresa WC011A

**STANDARD**



**OPZ09781B**  
Morsetto B - 997  
Jaw B - 997  
Spannbacke B - 997  
Étau B - 997  
Mordaza B - 997



2.5 mm



**RIC05304B**  
Fresino WC011A  
Cutter WC011A  
Fräser WC011A  
Fraise WC011A  
Fresa WC011A

**STANDARD**  
(VERSION 4 JAWS)



2.5 mm



**RIC05048B**  
*Fresino V003*  
*Cutter V003*  
*Fräser V003*  
*Fraise V003*  
*Fresa V003*

**OPZ04873B**  
*Morsetto A02*  
*Jaw A02*  
*Spannbacke A02*  
*Étau A02*  
*Mordaza A02*

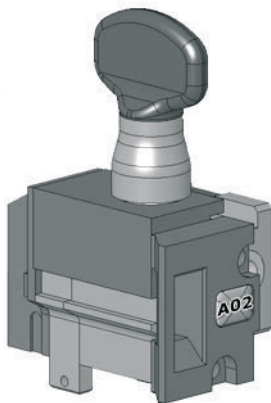

**NINJA TOTAL**



**NINJA VORTEX**



**VERSA**

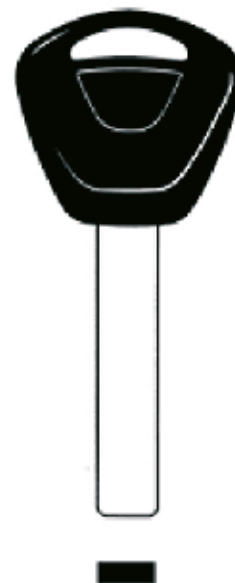

Acura (J)



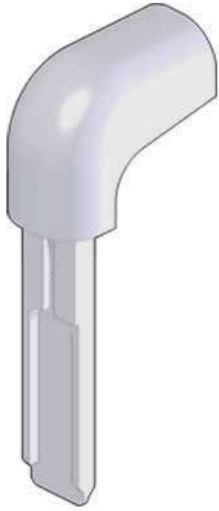

**EMERGENCY KEY**



**994 LASER**

**OPZ03182B**  
 Morsetto A-994  
 Jaw A-994  
 Spannbacke A-994  
 Étau A-994  
 Mordaza A-994  
**STANDARD**



**OPZ05223B**  
 Morsetto C-994  
 Jaw C-994  
 Spannbacke C-994  
 Étau C-994  
 Mordaza C-994  
**STANDARD**



**OPZ07885B**  
 Adattatore AD03 per chiavi Lexus  
 Adaptor AD03 for Lexus keys  
 Adapter AD03 für Lexus-Schlüssel  
 Adaptateur AD03 pour clés Lexus  
 Adaptador AD03 para llaves Lexus  
**OPTIONAL**

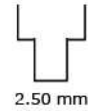

2.50 mm

**RIC05304B**  
 Fresino WC011A  
 Cutter WC011A  
 Fräser WC011A  
 Fraise WC011A  
 Fresa WC011A  
**STANDARD**



**NINJA LASER**

**OPZ09734B**  
 Morsetto A/C - 997  
 Jaw A/C - 997  
 Spannbacke A/C - 997  
 Étau A/C - 997  
 Mordaza A/C - 997  
**STANDARD**



**OPZ07885B**  
 Adattatore AD03 per chiavi Lexus  
 Adaptor AD03 for Lexus keys  
 Adapter AD03 für Lexus-Schlüssel  
 Adaptateur AD03 pour clés Lexus  
 Adaptador AD03 para llaves Lexus  
**OPTIONAL**

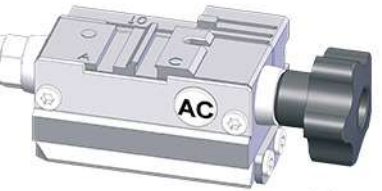

2.50 mm

**RIC05304B**  
 Fresino WC011A  
 Cutter WC011A  
 Fräser WC011A  
 Fraise WC011A  
 Fresa WC011A  
**STANDARD**



**NINJA VORTEX**



**OPZ10631B**  
 Adattatore AD06  
 Adaptor AD06  
 Adapter AD06  
 Adaptateur AD06  
 Adaptador AD06  
**OPTIONAL**



**RIC05048B**  
 Fresino V003  
 Cutter V003  
 Fräser V003  
 Fraise V003  
 Fresa V003  
**STANDARD**  
 (VERSION 4 JAWS)



2.5 mm

**OPZ04871B**  
 Morsetto A01  
 Jaw A01  
 Spannbacke A01  
 Étau A01  
 Mordaza A01  
**STANDARD**  
 (VERSION 4 JAWS)

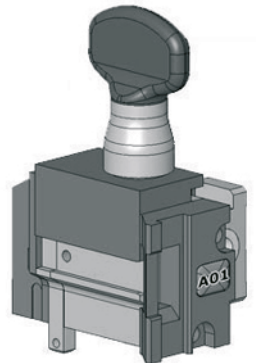

**VERSA**



**NINJA TOTAL**



**OPZ10631B**  
 Adattatore AD06  
 Adaptor AD06  
 Adapter AD06  
 Adaptateur AD06  
 Adaptador AD06  
**OPTIONAL**



**RIC05048B**  
 Fresino V003  
 Cutter V003  
 Fräser V003  
 Fraise V003  
 Fresa V003  
**STANDARD**

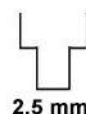

2.5 mm

**OPZ10569B**  
 Morsetto C30  
 Jaw C30  
 Spannbacke C30  
 Étau C30  
 Mordaza C30  
**STANDARD**



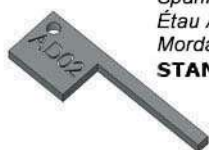

**OPZ09734B**  
Morsetto A/C - 997  
Jaw A/C - 997  
Spannbacke A/C - 997  
Étau A/C - 997  
Mordaza A/C - 997  
**STANDARD**

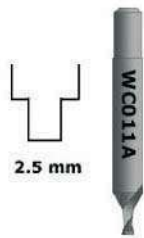
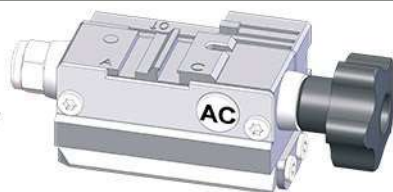

**RIC05304B**  
Fresino WC011A  
Cutter WC011A  
Fräser WC011A  
Fraise WC011A  
Fresa WC011A  
**STANDARD**

**OPZ05406B**  
Adattatore AD02 per chiavi Infiniti  
Adaptor AD02 for Infiniti keys  
Adapter AD02 für Infiniti-Schlüssel  
Adaptateur AD02 pour clés Infiniti  
Adaptador AD02 para llaves Infiniti  
**OPTIONAL**



**NINJA LASER**

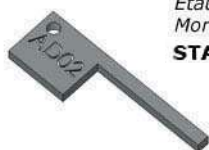

**OPZ03182B**  
Morsetto A-994  
Jaw A-994  
Spannbacke A-994  
Étau A-994  
Mordaza A-994  
**STANDARD**

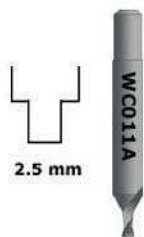

**RIC05304B**  
Fresino WC011A  
Cutter WC011A  
Fräser WC011A  
Fraise WC011A  
Fresa WC011A  
**STANDARD**

**OPZ05406B**  
Adattatore AD02 per chiavi Infiniti  
Adaptor AD02 for Infiniti keys  
Adapter AD02 für Infiniti-Schlüssel  
Adaptateur AD02 pour clés Infiniti  
Adaptador AD02 para llaves Infiniti  
**OPTIONAL**



**994 LASER**



**RIC05048B**  
Fresino V003  
Cutter V003  
Fräser V003  
Fraise V003  
Fresa V003  
**STANDARD**  
(VERSION 4 JAWS)

**OPZ04871B**  
Morsetto A01  
Jaw A01  
Spannbacke A01  
Étau A01  
Mordaza A01  
**STANDARD**  
(VERSION 4 JAWS)

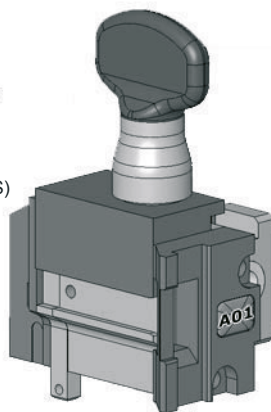

**NINJA VORTEX**



**OPZ05493B**  
Adattatore AV01 per chiavi Infiniti  
Adaptor AV01 for Infiniti keys  
Adapter AV01 für Infiniti-Schlüssel  
Adaptateur AV01 pour clés Infiniti  
Adaptador AV01 para llaves Infiniti  
**OPTIONAL**



**VERSA**



**RIC05048B**  
Fresino V003  
Cutter V003  
Fräser V003  
Fraise V003  
Fresa V003  
**STANDARD**

**OPZ10569B**  
Morsetto C30  
Jaw C30  
Spannbacke C30  
Étau C30  
Mordaza C30  
**STANDARD**



**NINJA TOTAL**

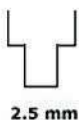

**OPZ05493B**  
Adattatore AV01 per chiavi Infiniti  
Adaptor AV01 for Infiniti keys  
Adapter AV01 für Infiniti-Schlüssel  
Adaptateur AV01 pour clés Infiniti  
Adaptador AV01 para llaves Infiniti  
**OPTIONAL**

**Short Keys**



**994 LASER**



**OPZ10269B**

*Adattatore AD05 per chiavi Short  
Adaptor AD05 for Short keys  
Adapter AD05 für Short-Schlüssel  
Adaptateur AD05 pour clés Short  
Adaptador AD05 para llaves Short*  
**OPTIONAL**

**OPZ03185B**

*Morsetto D-994  
Jaw D-994  
Spannbacke D-994  
Étau D-994  
Mordaza D-994*  
**STANDARD**

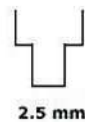

2.5 mm



**RIC05304B**

*Fresino WC011A  
Cutter WC011A  
Fräser WC011A  
Fraise WC011A  
Fresa WC011A*  
**STANDARD**



**NINJA LASER**



**OPZ10269B**

*Adattatore AD05 per chiavi Short  
Adaptor AD05 for Short keys  
Adapter AD05 für Short-Schlüssel  
Adaptateur AD05 pour clés Short  
Adaptador AD05 para llaves Short*  
**OPTIONAL**

**OPZ09783B**

*Morsetto D - 997  
Jaw D - 997  
Spannbacke D - 997  
Étau D - 997  
Mordaza D - 997*  
**STANDARD**

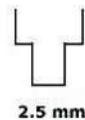
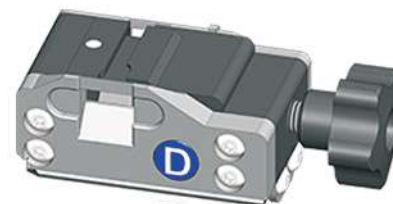

2.5 mm



**RIC05304B**

*Fresino WC011A  
Cutter WC011A  
Fräser WC011A  
Fraise WC011A  
Fresa WC011A*  
**STANDARD**



**NINJA TOTAL**



2.5 mm

**OPZ04877B**

*Morsetto A04  
Jaw A04  
Spannbacke A04  
Étau A04  
Mordaza A04*  
**OPTIONAL**

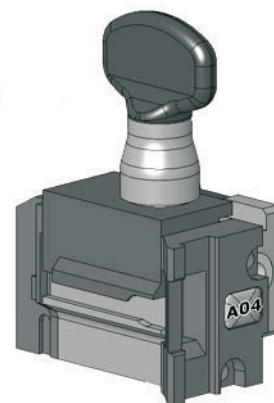

**NINJA VORTEX**



**RIC05048B**

*Fresino V003  
Cutter V003  
Fräser V003  
Fraise V003  
Fresa V003*  
**STANDARD**  
(VERSION 4 JAWS)



**OPTIONAL**

**OPZ05031B**

*Morsetto 05 per chiavi Tibbe*  
*Jaw 05 for Tibbe keys*  
*Spannbacke 05 für Tibbe-Schlüssel*  
*Étau 05 pour clés Tibbe*  
*Mordaza 05 para llaves Tibbe*

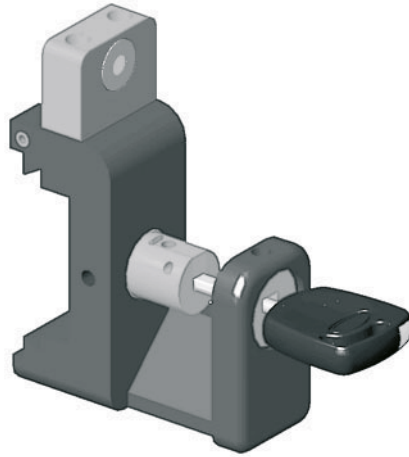

**POWER LYNX  
SIGMA PRO**



**OPTIONAL**

**OPZ08657B**

*Morsetto 01 per chiavi Tibbe*  
*Jaw 01 for Tibbe keys*  
*Spannbacke 01 für Tibbe Schlüssel*  
*Étau 01 pour clés Tibbe*  
*Mordaza 01 para llaves Tibbe*



**FALCON**



**JA1U**





**CARAT/106**



**101/102  
103/104**



**EURO/ECO  
EASY/LUPO**

**OPTIONAL**

**MC**

*Adattatori per chiavi Simplex  
Adaptors for Simplex keys  
Adapters für Simplex-Schlüssel  
Adaptateurs pour clés Simplex  
Adaptadores para llaves Simplex*



**994 LASER**

**OPTIONAL**

**OPZ09733B**

*Morsetto S per chiavi Simplex  
Jaw S for Simplex keys  
Spannbacke S für Simplex-Schlüssel  
Étau S pour clés Simplex  
Mordaza S para llaves Simplex*

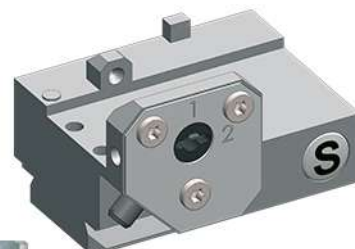

**RIC08409B**

*Fresino CL004  
Cutter CL004  
Fräser CL004  
Fraise CL004  
Fresa CL004*



**1,5 mm**



**INCLUDED WITH JAW**

*Tastatore TL002  
Tracer Point TL002  
Taster TL002  
Palpeur TL002  
Palpador TL002*



**CN22AP  
CN22CP  
CN22U  
CN22TK1  
CN22TK8**

**OPTIONAL**



**OPZ08264B**  
*Adattatore B6 per chiavi Simplex*  
*Adaptor B6 sides for Simplex keys*  
*Adapter B6 für Simplex Schlüssel*  
*Adaptateur B6 pour clés Simplex*  
*Adaptador B6 para llaves Simplex*



**DEZMO**



**NINJA LASER**



**NINJA TOTAL**



**CN22AP**  
**CN22CP**  
**CN22U**  
**CN22TK1**  
**CN22TK8**



EMERGENCY KEY



994 LASER

**OPZ03182B**  
 Morsetto A-994  
 Jaw A-994  
 Spannbacke A-994  
 Étau A-994  
 Mordaza A-994  
**STANDARD**



**OPZ05223B**  
 Morsetto C-994  
 Jaw C-994  
 Spannbacke C-994  
 Étau C-994  
 Mordaza C-994  
**STANDARD**



**OPZ07885B**  
 Adattatore AD03 per chiavi Lexus  
 Adaptor AD03 for Lexus keys  
 Adapter AD03 für Lexus-Schlüssel  
 Adaptateur AD03 pour clés Lexus  
 Adaptador AD03 para llaves Lexus  
**OPTIONAL**



**RIC05304B**  
 Fresino WC011A  
 Cutter WC011A  
 Fräser WC011A  
 Fraise WC011A  
 Fresa WC011A  
**STANDARD**



NINJA LASER

**OPZ09734B**  
 Morsetto A/C - 997  
 Jaw A/C - 997  
 Spannbacke A/C - 997  
 Étau A/C - 997  
 Mordaza A/C - 997  
**STANDARD**



**OPZ07885B**  
 Adattatore AD03 per chiavi Lexus  
 Adaptor AD03 for Lexus keys  
 Adapter AD03 für Lexus-Schlüssel  
 Adaptateur AD03 pour clés Lexus  
 Adaptador AD03 para llaves Lexus  
**OPTIONAL**

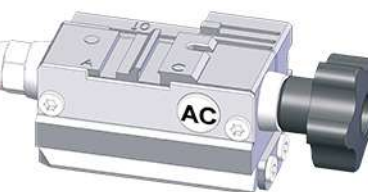

**RIC05304B**  
 Fresino WC011A  
 Cutter WC011A  
 Fräser WC011A  
 Fraise WC011A  
 Fresa WC011A  
**STANDARD**



NINJA VORTEX



**OPZ10631B**  
 Adattatore AD06  
 Adaptor AD06  
 Adapter AD06  
 Adaptateur AD06  
 Adaptador AD06  
**OPTIONAL**



**RIC05048B**  
 Fresino V003  
 Cutter V003  
 Fräser V003  
 Fraise V003  
 Fresa V003  
**STANDARD**  
 (VERSION 4 JAWS)



**OPZ04871B**  
 Morsetto A01  
 Jaw A01  
 Spannbacke A01  
 Étau A01  
 Mordaza A01  
**STANDARD**  
 (VERSION 4 JAWS)

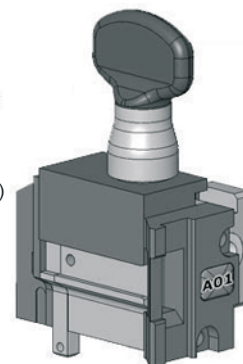

VERSA



NINJA TOTAL



**OPZ10631B**  
 Adattatore AD06  
 Adaptor AD06  
 Adapter AD06  
 Adaptateur AD06  
 Adaptador AD06  
**OPTIONAL**



**RIC05048B**  
 Fresino V003  
 Cutter V003  
 Fräser V003  
 Fraise V003  
 Fresa V003  
**STANDARD**

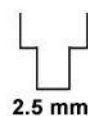

**OPZ10569B**  
 Morsetto C30  
 Jaw C30  
 Spannbacke C30  
 Étau C30  
 Mordaza C30  
**STANDARD**



STANDARD



2.5 mm

**RIC01810B**  
Fresino HC011  
Cutter HC011  
Fräser HC011  
Fraise HC011  
Fresa HC011



**RIC01811B**  
Tastatore C011  
Tracer Point C011  
Taster C011  
Palpeur C011  
Palpador C011



**303/304/305**



**T-REX  
T-REX ADVANCE**



**PUNTO**



STANDARD

**OPZ03182B**  
Morsetto A-994  
Jaw A-994  
Spannbacke A-994  
Étau A-994  
Mordaza A-994

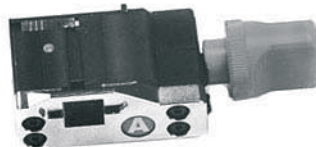

**994 LASER**

  
**TR49TK**



2.5 mm



**RIC05304B**  
Fresino WC011A  
Cutter WC011A  
Fräser WC011A  
Fraise WC011A  
Fresa WC011A

STANDARD

**OPZ09734B**  
Morsetto A/C - 997  
Jaw A/C - 997  
Spannbacke A/C - 997  
Étau A/C - 997  
Mordaza A/C - 997

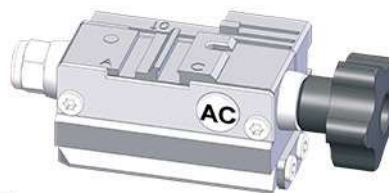

**NINJA LASER**



2.5 mm



**RIC05304B**  
Fresino WC011A  
Cutter WC011A  
Fräser WC011A  
Fraise WC011A  
Fresa WC011A





  
TR49TK



**NINJA VORTEX**



**VERSA**



**NINJA TOTAL**

**STANDARD**  
(VERSION 4 JAWS)



2.5 mm



**RIC05048B**  
Fresino V003  
Cutter V003  
Fräser V003  
Fraise V003  
Fresa V003

**OPZ04871B**  
Morsetto A01  
Jaw A01  
Spannbacke A01  
Étau A01  
Mordaza A01

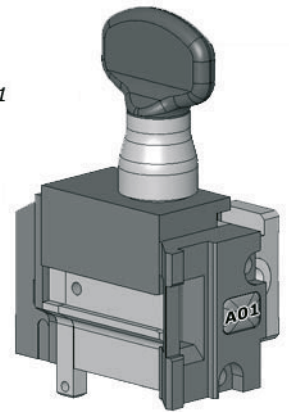

**STANDARD**



2.5 mm



**RIC05048B**  
Fresino V003  
Cutter V003  
Fräser V003  
Fraise V003  
Fresa V003

**OPZ10569B**  
Morsetto C30  
Jaw C30  
Spannbacke C30  
Étau C30  
Mordaza C30



STANDARD



2.5 mm

**RIC01810B**  
Fresino HC011  
Cutter HC011  
Fräser HC011  
Fraise HC011  
Fresa HC011



**RIC01811B**  
Tastatore C011  
Tracer Point C011  
Taster C011  
Palpeur C011  
Palpador C011



**303/304/305**



**T-REX  
T-REX ADVANCE**



**PUNTO**

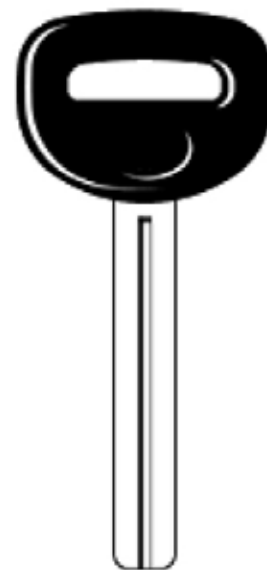

STANDARD

**OPZ03182B**  
Morsetto A-994  
Jaw A-994  
Spannbacke A-994  
Étau A-994  
Mordaza A-994



**994 LASER**



2.5 mm



**RIC05304B**  
Fresino WC011A  
Cutter WC011A  
Fräser WC011A  
Fraise WC011A  
Fresa WC011A

STANDARD

**OPZ09734B**  
Morsetto A/C - 997  
Jaw A/C - 997  
Spannbacke A/C - 997  
Étau A/C - 997  
Mordaza A/C - 997

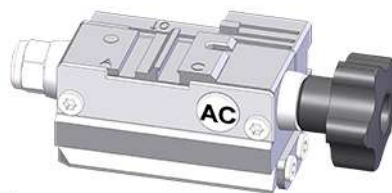

**NINJA LASER**



2.5 mm



**RIC05304B**  
Fresino WC011A  
Cutter WC011A  
Fräser WC011A  
Fraise WC011A  
Fresa WC011A

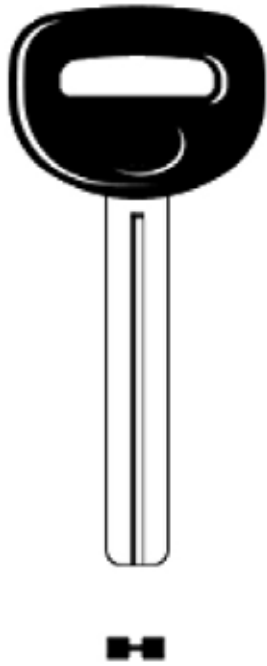

**NINJA VORTEX**



**VERSA**



**NINJA TOTAL**

**STANDARD**  
(VERSION 4 JAWS)



2.5 mm



**RIC05048B**  
Fresino V003  
Cutter V003  
Fräser V003  
Fraise V003  
Fresa V003

**OPZ04871B**  
Morsetto A01  
Jaw A01  
Spannbacke A01  
Étau A01  
Mordaza A01

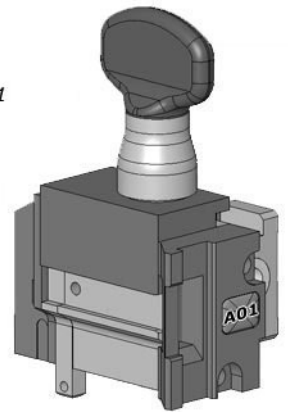

**STANDARD**



2.5 mm



**RIC05048B**  
Fresino V003  
Cutter V003  
Fräser V003  
Fraise V003  
Fresa V003

**OPZ10569B**  
Morsetto C30  
Jaw C30  
Spannbacke C30  
Étau C30  
Mordaza C30

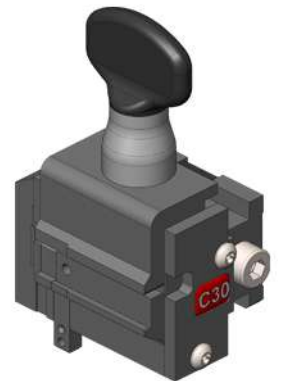

TO  
FIT :

MERCEDES (D)

**OPTIONAL**

**MM**  
Morsetti per chiavi Mercedes  
Jaws for Mercedes keys  
Spannbacken für Mercedes-Schlüssel  
Étaux pour clés Mercedes  
Mordazas para llaves Mercedes



**303/304/305**



**T-REX  
T-REX ADVANCE**



**PUNTO**

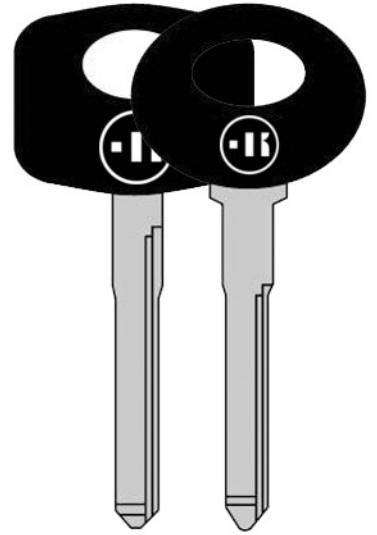

**MB57P**



**MB54P**



**MB41P**

**STANDARD**

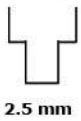

2.5 mm

**RIC01810B**  
Fresino HC011  
Cutter HC011  
Fräser HC011  
Fraise HC011  
Fresa HC011



**RIC01811B**  
Tastatore C011  
Tracer Point C011  
Taster C011  
Palpeur C011  
Palpador C011

**STANDARD**

**OPZ03185B**  
Morsetto D-994  
Jaw D-994  
Spannbacke D-994  
Étau D-994  
Mordaza D-994



**994 LASER**



2.5 mm



**RIC05304B**  
Fresino WC011A  
Cutter WC011A  
Fräser WC011A  
Fraise WC011A  
Fresa WC011A

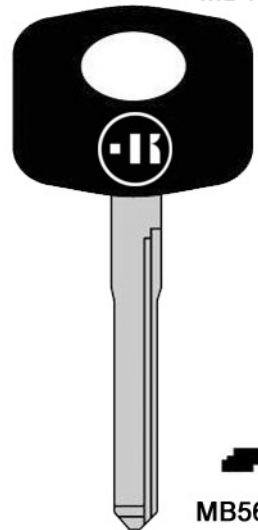

**MB56P**

**STANDARD**

**OPZ09783B**  
Morsetto D - 997  
Jaw D - 997  
Spannbacke D - 997  
Étau D - 997  
Mordaza D - 997

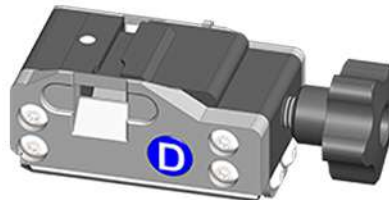

**NINJA LASER**

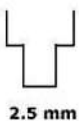

2.5 mm



**RIC05304B**  
Fresino WC011A  
Cutter WC011A  
Fräser WC011A  
Fraise WC011A  
Fresa WC011A

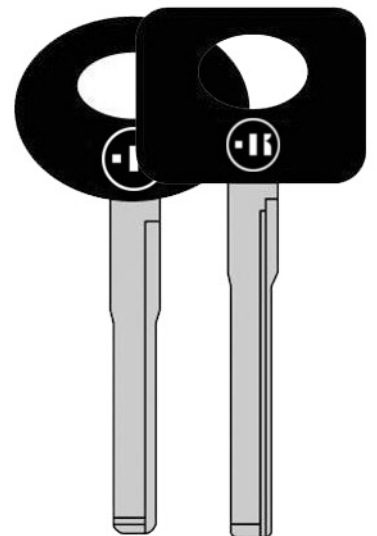

**MB58P**



**MB55P**



**MB59P**



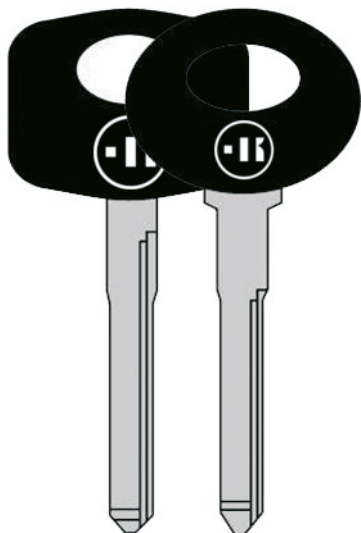

MB57P MB54P  
MB41P

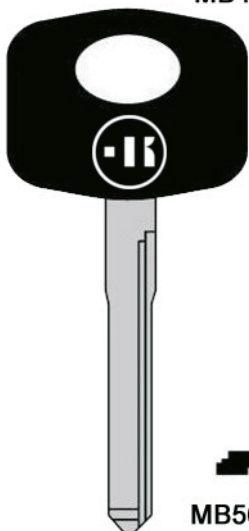

MB56P

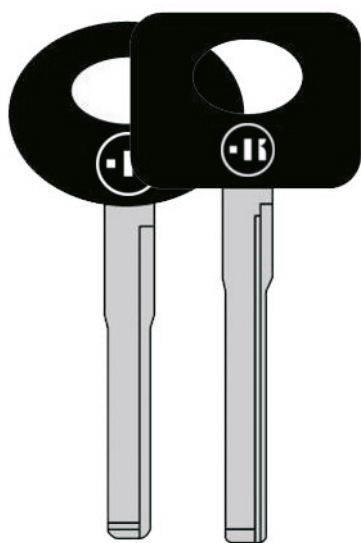

MB58P MB55P  
MB59P



**NINJA TOTAL**



**NINJA VORTEX**



**VERSA**



2.5 mm



**RIC05048B**  
Fresino V003  
Cutter V003  
Fräser V003  
Fraise V003  
Fresa V003

**STANDARD**  
(VERSION 4 JAWS)

**OPZ04877B**  
Morsetto A04  
Jaw A04  
Spannbacke A04  
Étau A04  
Mordaza A04  
OPTIONAL

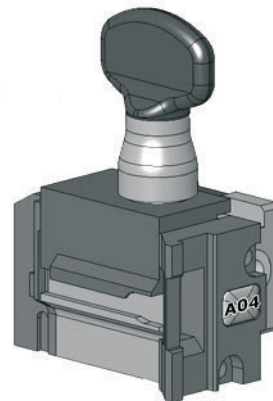

STANDARD



2.5 mm

**RIC01810B**  
Fresino HC011  
Cutter HC011  
Fräser HC011  
Fraise HC011  
Fresa HC011



**RIC01811B**  
Tastatore C011  
Tracer Point C011  
Taster C011  
Palpeur C011  
Palpador C011



**303/304/305**



**T-REX  
T-REX ADVANCE**



**PUNTO**

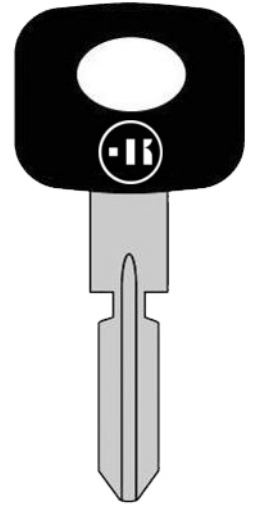

STANDARD

**OPZ03182B**  
Morsetto A-994  
Jaw A-994  
Spannbacke A-994  
Étau A-994  
Mordaza A-994



**994 LASER**



**MB52P**



2.5 mm



**RIC05304B**  
Fresino WC011A  
Cutter WC011A  
Fräser WC011A  
Fraise WC011A  
Fresa WC011A

STANDARD

**OPZ09734B**  
Morsetto A/C - 997  
Jaw A/C - 997  
Spannbacke A/C - 997  
Étau A/C - 997  
Mordaza A/C - 997

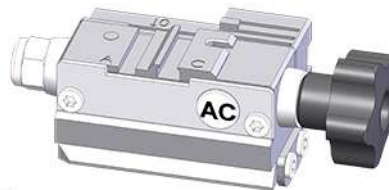

**NINJA LASER**



2.5 mm



**RIC05304B**  
Fresino WC011A  
Cutter WC011A  
Fräser WC011A  
Fraise WC011A  
Fresa WC011A

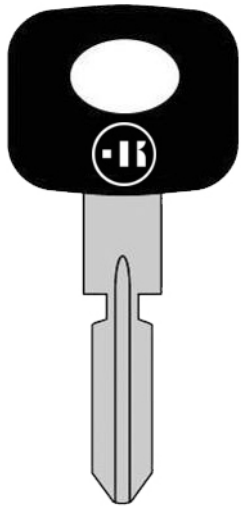

**MB52P**



**NINJA VORTEX**



**VERSA**



**NINJA TOTAL**

**STANDARD**  
(VERSION 4 JAWS)



2.5 mm



**RIC05048B**  
Fresino V003  
Cutter V003  
Fräser V003  
Fraise V003  
Fresa V003

**OPZ04871B**  
Morsetto A01  
Jaw A01  
Spannbacke A01  
Étau A01  
Mordaza A01

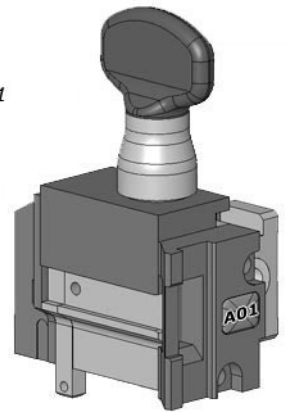

**STANDARD**



2.5 mm



**RIC05048B**  
Fresino V003  
Cutter V003  
Fräser V003  
Fraise V003  
Fresa V003

**OPZ10569B**  
Morsetto C30  
Jaw C30  
Spannbacke C30  
Étau C30  
Mordaza C30

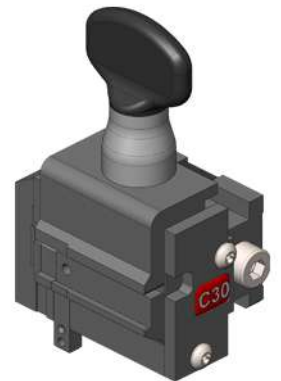



**OPZ03185B**  
Morsetto D-994  
Jaw D-994  
Spannbacke D-994  
Étau D-994  
Mordaza D-994  
**STANDARD**



**994 LASER**

**Short Keys**



**OPZ10269B**  
Adattatore AD05 per chiavi Short  
Adaptor AD05 for Short keys  
Adapter AD05 für Short-Schlüssel  
Adaptateur AD05 pour clés Short  
Adaptador AD05 para llaves Short  
**OPTIONAL**



2.5 mm



**RIC05304B**  
Fresino WC011A  
Cutter WC011A  
Fräser WC011A  
Fraise WC011A  
Fresa WC011A  
**STANDARD**



**OPZ09783B**  
Morsetto D - 997  
Jaw D - 997  
Spannbacke D - 997  
Étau D - 997  
Mordaza D - 997  
**STANDARD**

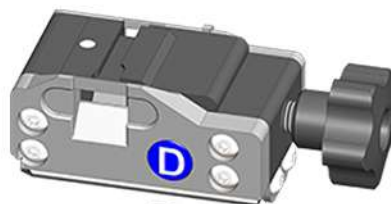

**NINJA LASER**

**OPZ10269B**  
Adattatore AD05 per chiavi Short  
Adaptor AD05 for Short keys  
Adapter AD05 für Short-Schlüssel  
Adaptateur AD05 pour clés Short  
Adaptador AD05 para llaves Short  
**OPTIONAL**



2.5 mm



**RIC05304B**  
Fresino WC011A  
Cutter WC011A  
Fräser WC011A  
Fraise WC011A  
Fresa WC011A  
**STANDARD**

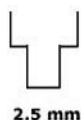

2.5 mm

**OPZ04877B**  
Morsetto A04  
Jaw A04  
Spannbacke A04  
Étau A04  
Mordaza A04  
**OPTIONAL**

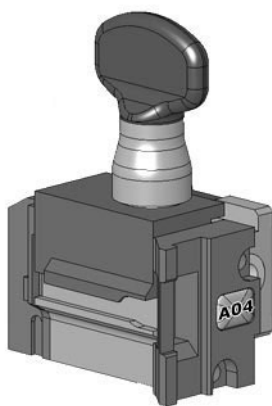

**NINJA TOTAL**



**RIC05048B**  
Fresino V003  
Cutter V003  
Fräser V003  
Fraise V003  
Fresa V003  
**STANDARD**  
(VERSION 4 JAWS)



**NINJA VORTEX**



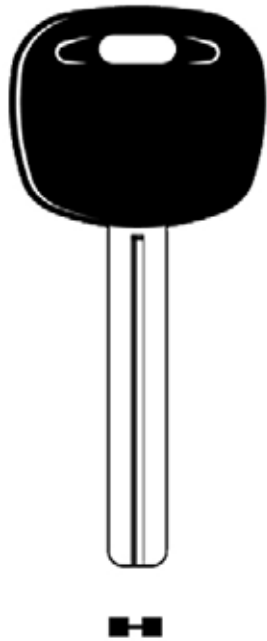

**303/304/305**

**T-REX  
T-REX ADVANCE**

**PUNTO**

**STANDARD**

2.5 mm

**RIC01810B**  
Fresino HC011  
Cutter HC011  
Fräser HC011  
Fraise HC011  
Fresa HC011

**RIC01811B**  
Tastatore C011  
Tracer Point C011  
Taster C011  
Palpeur C011  
Palpador C011



**994 LASER**

**STANDARD**

**OPZ03182B**  
Morsetto A-994  
Jaw A-994  
Spannbacke A-994  
Étau A-994  
Mordaza A-994

2.5 mm

**RIC05304B**  
Fresino WC011A  
Cutter WC011A  
Fräser WC011A  
Fraise WC011A  
Fresa WC011A



**NINJA LASER**

**STANDARD**

**OPZ09734B**  
Morsetto A/C - 997  
Jaw A/C - 997  
Spannbacke A/C - 997  
Étau A/C - 997  
Mordaza A/C - 997

2.5 mm

**RIC05304B**  
Fresino WC011A  
Cutter WC011A  
Fräser WC011A  
Fraise WC011A  
Fresa WC011A

TO  
FIT :

MITSUBISHI (J)

**STANDARD**  
(VERSION 4 JAWS)



2.5 mm



**RIC05048B**  
Fresino V003  
Cutter V003  
Fräser V003  
Fraise V003  
Fresa V003

**OPZ04871B**  
Morsetto A01  
Jaw A01  
Spannbacke A01  
Étau A01  
Mordaza A01

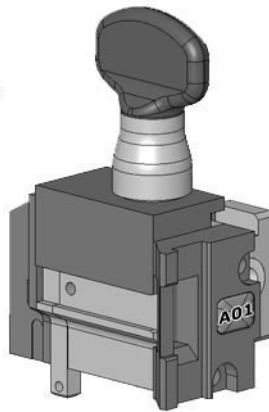

**NINJA VORTEX**



**VERSA**

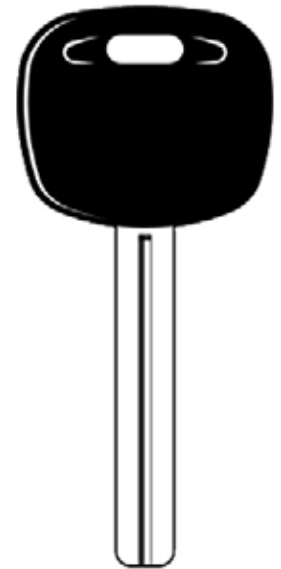

**STANDARD**



2.5 mm



**RIC05048B**  
Fresino V003  
Cutter V003  
Fräser V003  
Fraise V003  
Fresa V003

**OPZ10569B**  
Morsetto C30  
Jaw C30  
Spannbacke C30  
Étau C30  
Mordaza C30



**NINJA TOTAL**





**NINJA TOTAL**



**NINJA VORTEX**



**VERSA**

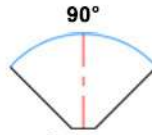

90°

0.4 mm



V001

**RIC05044B**  
Fresino V001  
Cutter V001  
Fräser V001  
Fraise V001  
Fresa V001  
**STANDARD**

**OPZ07800B**  
Morsetto C15  
Jaw C15  
Spannbacke C15  
Étau C15  
Mordaza C15  
**OPTIONAL**



TO  
FIT :

# OPEL (D) - VAUXHALL (GB)

## OPTIONAL

### MOMAX

Adattatori per chiavi Opel e Ford C-MAX  
Adaptors for Opel and Ford C-MAX keys  
Adapters für Opel und Ford C-MAX-Schlüssel  
Adaptateurs pour clés Opel et Ford C-MAX  
Adaptadores para llaves Opel y Ford C-MAX



## STANDARD

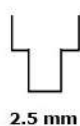

**RIC01810B**  
Fresino HC011  
Cutter HC011  
Fräser HC011  
Fraise HC011  
Fresa HC011



**RIC01811B**  
Tastatore C011  
Tracer Point C011  
Taster C011  
Palpeur C011  
Palpador C011



**303/304/305**



**T-REX  
T-REX ADVANCE**



**PUNTO**



VX4TK12

VX4TK5

VX4P

VX3P

## STANDARD

### OPZ03182B

Morsetto A-994  
Jaw A-994  
Spannbacke A-994  
Étau A-994  
Mordaza A-994

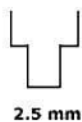

2.5 mm



**RIC05304B**  
Fresino WC011A  
Cutter WC011A  
Fräser WC011A  
Fraise WC011A  
Fresa WC011A



**994 LASER**



## STANDARD

### OPZ09734B

Morsetto A/C - 997  
Jaw A/C - 997  
Spannbacke A/C - 997  
Étau A/C - 997  
Mordaza A/C - 997

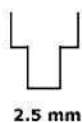
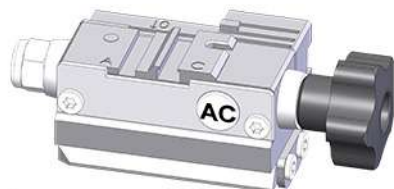

2.5 mm



**RIC05304B**  
Fresino WC011A  
Cutter WC011A  
Fräser WC011A  
Fraise WC011A  
Fresa WC011A



**NINJA LASER**



VX3TK5



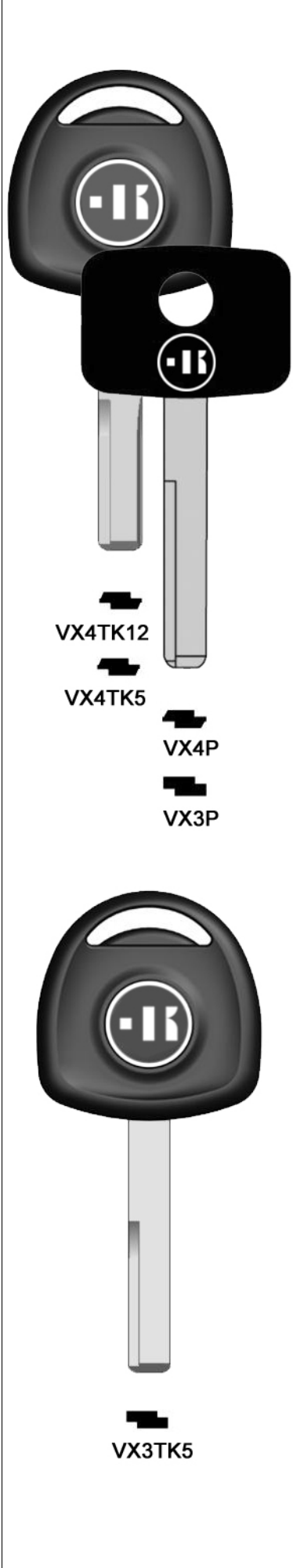

VX4TK12

VX4TK5

VX4P

VX3P

VX3TK5



**NINJA VORTEX**



**VERSA**



**NINJA TOTAL**

**STANDARD**  
(VERSION 4 JAWS)



2.5 mm



**RIC05048B**  
Fresino V003  
Cutter V003  
Fräser V003  
Fraise V003  
Fresa V003

**OPZ04871B**  
Morsetto A01  
Jaw A01  
Spannbacke A01  
Étau A01  
Mordaza A01

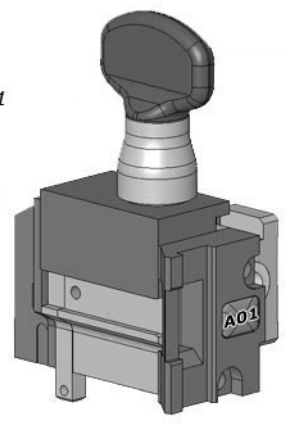

**STANDARD**

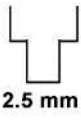

2.5 mm



**RIC05048B**  
Fresino V003  
Cutter V003  
Fräser V003  
Fraise V003  
Fresa V003

**OPZ10569B**  
Morsetto C30  
Jaw C30  
Spannbacke C30  
Étau C30  
Mordaza C30



TO  
FIT :

OPEL (D) - VAUXHALL (GB)

STANDARD



2.5 mm

**RIC01810B**  
*Fresino HC011*  
*Cutter HC011*  
*Fräser HC011*  
*Fraise HC011*  
*Fresa HC011*



**RIC01811B**  
*Tastatore C011*  
*Tracer Point C011*  
*Taster C011*  
*Palpeur C011*  
*Palpador C011*



**303/304/305**



**T-REX  
T-REX ADVANCE**



**PUNTO**



VX5TK12

STANDARD

**OPZ03182B**  
*Morsetto A-994*  
*Jaw A-994*  
*Spannbacke A-994*  
*Étau A-994*  
*Mordaza A-994*



2.5 mm



**RIC05304B**  
*Fresino WC011A*  
*Cutter WC011A*  
*Fräser WC011A*  
*Fraise WC011A*  
*Fresa WC011A*



**994 LASER**

STANDARD

**OPZ09734B**  
*Morsetto A/C - 997*  
*Jaw A/C - 997*  
*Spannbacke A/C - 997*  
*Étau A/C - 997*  
*Mordaza A/C - 997*

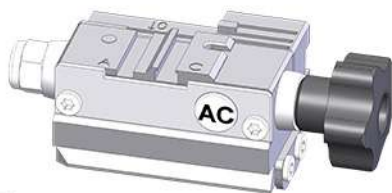

2.5 mm



**RIC05304B**  
*Fresino WC011A*  
*Cutter WC011A*  
*Fräser WC011A*  
*Fraise WC011A*  
*Fresa WC011A*



**NINJA LASER**



VX5TK12



**NINJA VORTEX**



**VERSA**



**NINJA TOTAL**

**STANDARD**  
(VERSION 4 JAWS)



2.5 mm



**RIC05048B**  
Fresino V003  
Cutter V003  
Fräser V003  
Fraise V003  
Fresa V003

**OPZ04871B**  
Morsetto A01  
Jaw A01  
Spannbacke A01  
Étau A01  
Mordaza A01

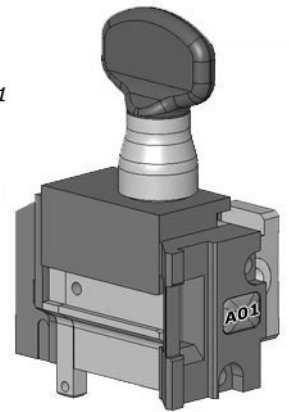

**STANDARD**



2.5 mm



**RIC05048B**  
Fresino V003  
Cutter V003  
Fräser V003  
Fraise V003  
Fresa V003

**OPZ10569B**  
Morsetto C30  
Jaw C30  
Spannbacke C30  
Étau C30  
Mordaza C30



**OPTIONAL**



2 mm

**RIC01816B**  
Fresino HC044  
Cutter HC044  
Fräser HC044  
Fraise HC044  
Fresa HC044



**RIC01817B**  
Tastatore C044  
Tracer Point C044  
Taster C044  
Palpeur C044  
Palpador C044



**303/304/305**



**T-REX  
T-REX ADVANCE**



**PUNTO**



**VX5BTK**

**STANDARD**

**OPZ05223B**  
Morsetto C-994  
Jaw C-994  
Spannbacke C-994  
Étau C-994  
Mordaza C-994



**994 LASER**



2.5 mm



**RIC05304B**  
Fresino WC011A  
Cutter WC011A  
Fräser WC011A  
Fraise WC011A  
Fresa WC011A

**STANDARD**

**OPZ09734B**  
Morsetto A/C - 997  
Jaw A/C - 997  
Spannbacke A/C - 997  
Étau A/C - 997  
Mordaza A/C - 997

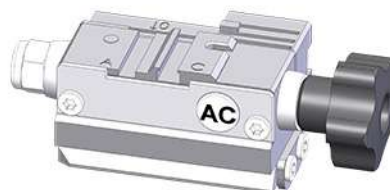

**NINJA LASER**



2.5 mm



**RIC05304B**  
Fresino WC011A  
Cutter WC011A  
Fräser WC011A  
Fraise WC011A  
Fresa WC011A



**NINJA TOTAL**



**NINJA VORTEX**



**VERSA**

**STANDARD**  
(VERSION 4 JAWS)



2.5 mm

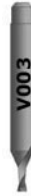

**RIC05048B**  
*Fresino V003*  
*Cutter V003*  
*Fräser V003*  
*Fraise V003*  
*Fresa V003*

**OPZ04875B**  
*Morsetto A03*  
*Jaw A03*  
*Spannbacke A03*  
*Étau A03*  
*Mordaza A03*

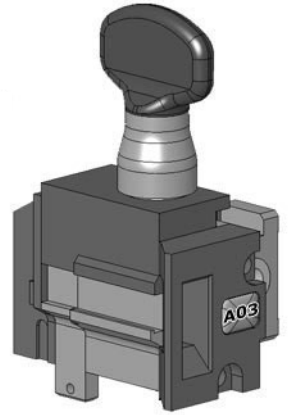



STANDARD



2.5 mm

**RIC01810B**  
Fresino HC011  
Cutter HC011  
Fräser HC011  
Fraise HC011  
Fresa HC011



**RIC01811B**  
Tastatore C011  
Tracer Point C011  
Taster C011  
Palpeur C011  
Palpador C011



**303/304/305**



**T-REX  
T-REX ADVANCE**



**PUNTO**

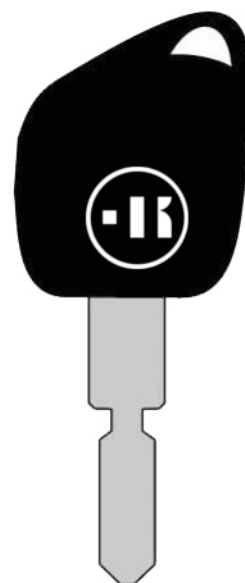

STANDARD

**OPZ03183B**  
Morsetto B-994  
Jaw B-994  
Spannbacke B-994  
Étau B-994  
Mordaza B-994



**994 LASER**



2.5 mm



**RIC05304B**  
Fresino WC011A  
Cutter WC011A  
Fräser WC011A  
Fraise WC011A  
Fresa WC011A



**PG31TK1**

STANDARD

**OPZ09781B**  
Morsetto B - 997  
Jaw B - 997  
Spannbacke B - 997  
Étau B - 997  
Mordaza B - 997



**NINJA LASER**



2.5 mm



**RIC05304B**  
Fresino WC011A  
Cutter WC011A  
Fräser WC011A  
Fraise WC011A  
Fresa WC011A

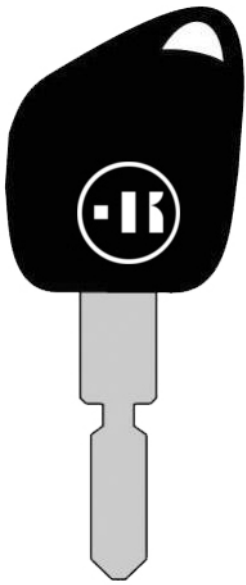

PG31TK1



**NINJA TOTAL**



**NINJA VORTEX**



**VERSA**

**STANDARD**  
(VERSION 4 JAWS)



2.5 mm



**RIC05048B**  
Fresino V003  
Cutter V003  
Fräser V003  
Fraise V003  
Fresa V003

**OPZ04873B**  
Morsetto A02  
Jaw A02  
Spannbacke A02  
Étau A02  
Mordaza A02

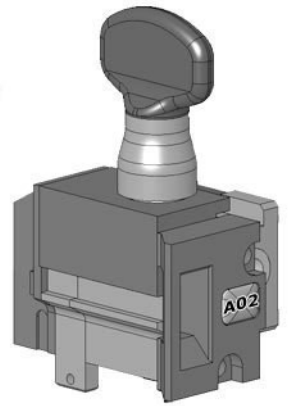

**OPTIONAL**



3,0 mm

**RIC01715B**  
Fresino HC030  
Cutter HC030  
Fräser HC030  
Fraise HC030  
Fresa HC030



**RIC01716B**  
Tastatore C030  
Tracer Point C030  
Taster C030  
Palpeur C030  
Palpador C030



**303/304/305**



**T-REX  
T-REX ADVANCE**



**PUNTO**



**PG83TK**

**STANDARD**

**OPZ05223B**  
Morsetto C-994  
Jaw C-994  
Spannbacke C-994  
Étau C-994  
Mordaza C-994



**994 LASER**



2.5 mm



**RIC05304B**  
Fresino WC011A  
Cutter WC011A  
Fräser WC011A  
Fraise WC011A  
Fresa WC011A

**STANDARD**

**OPZ09734B**  
Morsetto A/C - 997  
Jaw A/C - 997  
Spannbacke A/C - 997  
Étau A/C - 997  
Mordaza A/C - 997

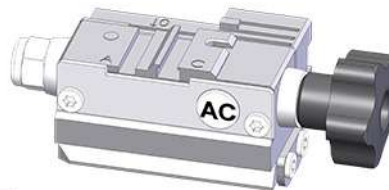

**NINJA LASER**



2.5 mm



**RIC05304B**  
Fresino WC011A  
Cutter WC011A  
Fräser WC011A  
Fraise WC011A  
Fresa WC011A



  
PG83TK



**NINJA TOTAL**



**NINJA VORTEX**



**VERSA**

**STANDARD**  
(VERSION 4 JAWS)



2.5 mm

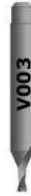

**RIC05048B**  
Fresino V003  
Cutter V003  
Fräser V003  
Fraise V003  
Fresa V003

**OPZ04875B**  
Morsetto A03  
Jaw A03  
Spannbacke A03  
Étau A03  
Mordaza A03

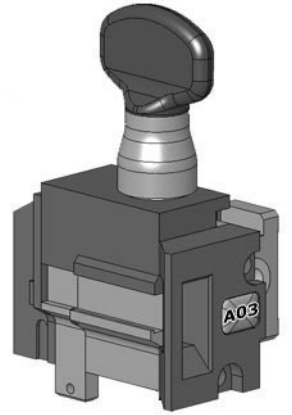

**STANDARD**



2.5 mm

**RIC01810B**  
Fresino HC011  
Cutter HC011  
Fräser HC011  
Fraise HC011  
Fresa HC011



**RIC01811B**  
Tastatore C011  
Tracer Point C011  
Taster C011  
Palpeur C011  
Palpador C011



**303/304/305**



**T-REX  
T-REX ADVANCE**



**PUNTO**



**STANDARD**

**OPZ03182B**  
Morsetto A-994  
Jaw A-994  
Spannbacke A-994  
Étau A-994  
Mordaza A-994



**994 LASER**

PG33TK



2.5 mm



**RIC05304B**  
Fresino WC011A  
Cutter WC011A  
Fräser WC011A  
Fraise WC011A  
Fresa WC011A

**STANDARD**

**OPZ09734B**  
Morsetto A/C - 997  
Jaw A/C - 997  
Spannbacke A/C - 997  
Étau A/C - 997  
Mordaza A/C - 997

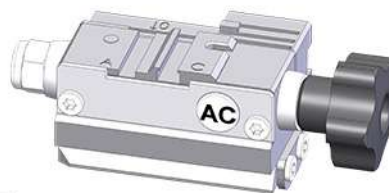

**NINJA LASER**



2.5 mm



**RIC05304B**  
Fresino WC011A  
Cutter WC011A  
Fräser WC011A  
Fraise WC011A  
Fresa WC011A





PG33TK



**NINJA TOTAL**



**NINJA VORTEX**



**VERSA**

**STANDARD**  
(VERSION 4 JAWS)



2.5 mm

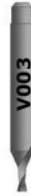

**RIC05048B**  
Fresino V003  
Cutter V003  
Fräser V003  
Fraise V003  
Fresa V003

**OPZ04875B**  
Morsetto A03  
Jaw A03  
Spannbacke A03  
Étau A03  
Mordaza A03

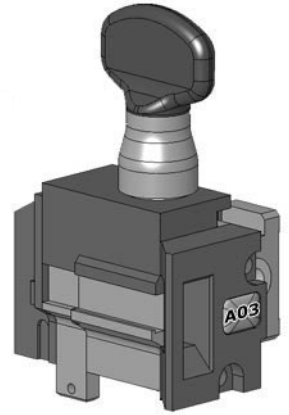

**OPTIONAL**

**MC**

*Adattatori per chiavi Simplex  
Adaptors for Simplex keys  
Adapters für Simplex-Schlüssel  
Adaptateurs pour clés Simplex  
Adaptadores para llaves Simplex*



**CARAT/106**



**101/102  
103/104**



**EURO/ECO  
EASY/LUPO**



**OPTIONAL**

**OPZ09733B**

*Morsetto S per chiavi Simplex  
Jaw S for Simplex keys  
Spannbacke S für Simplex-Schlüssel  
Étau S pour clés Simplex  
Mordaza S para llaves Simplex*

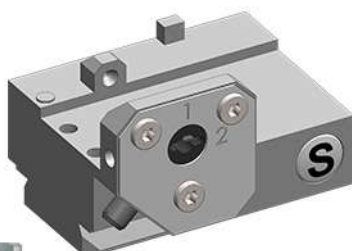

**RIC08409B**

*Fresino CL004  
Cutter CL004  
Fräser CL004  
Fraise CL004  
Fresa CL004*

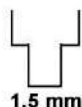

1,5 mm



**INCLUDED WITH JAW**

*Tastatore TL002  
Tracer Point TL002  
Taster TL002  
Palpeur TL002  
Palpador TL002*



**994 LASER**



**CN22AP  
CN22CP  
CN22U  
CN22TK1  
CN22TK8**



**DEZMO**



**NINJA LASER**



**NINJA TOTAL**

**OPTIONAL**



**OPZ08264B**

*Adattatore B6 per chiavi Simplex  
Adaptor B6 sides for Simplex keys  
Adapter B6 für Simplex Schlüssel  
Adaptateur B6 pour clés Simplex  
Adaptador B6 para llaves Simplex*



**CN22AP  
CN22CP  
CN22U  
CN22TK1  
CN22TK8**



**OPZ05223B**  
Morsetto C-994  
Jaw C-994  
Spannbacke C-994  
Étau C-994  
Mordaza C-994  
**STANDARD**



**994 LASER**

**OPZ10063B**  
Adattatore AD04 per chiavi Renault  
Adaptor AD04 for Renault keys  
Adapter AD04 für Renault-Schlüssel  
Adaptateur AD04 pour clés Renault  
Adaptador AD04 para llaves Renault  
**OPTIONAL**

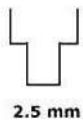

2.5 mm



**RIC05304B**  
Fresino WC011A  
Cutter WC011A  
Fräser WC011A  
Fraise WC011A  
Fresa WC011A  
**STANDARD**

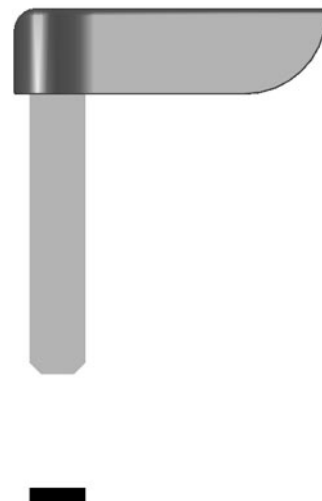

**OPZ09734B**  
Morsetto A/C - 997  
Jaw A/C - 997  
Spannbacke A/C - 997  
Étau A/C - 997  
Mordaza A/C - 997  
**STANDARD**

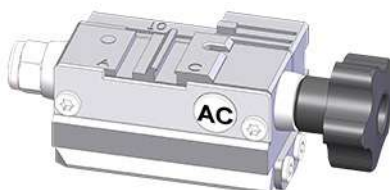

**NINJA LASER**

**OPZ10063B**  
Adattatore AD04 per chiavi Renault  
Adaptor AD04 for Renault keys  
Adapter AD04 für Renault-Schlüssel  
Adaptateur AD04 pour clés Renault  
Adaptador AD04 para llaves Renault  
**OPTIONAL**

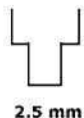

2.5 mm



**RIC05304B**  
Fresino WC011A  
Cutter WC011A  
Fräser WC011A  
Fraise WC011A  
Fresa WC011A  
**STANDARD**

**OPZ05345B**  
Adattatore AV02 per chiavi Renault  
Adaptor AV02 for Renault keys  
Adapter AV02 für Renault-Schlüssel  
Adaptateur AV02 pour clés Renault  
Adaptador AV02 para llaves Renault  
**OPTIONAL**

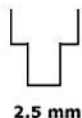

2.5 mm



**OPZ04875B**  
Morsetto A03  
Jaw A03  
Spannbacke A03  
Étau A03  
Mordaza A03  
**STANDARD**  
(VERSION 4 JAWS)

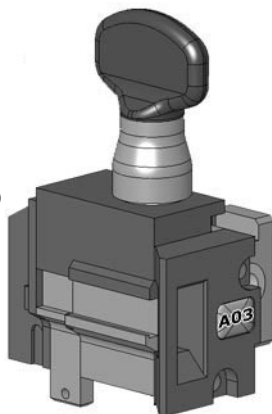

**NINJA TOTAL**



**NINJA VORTEX**

**RIC05048B**  
Fresino V003  
Cutter V003  
Fräser V003  
Fraise V003  
Fresa V003  
**STANDARD**  
(VERSION 4 JAWS)



**VERSA**

TO FIT: **RENAULT (F)**

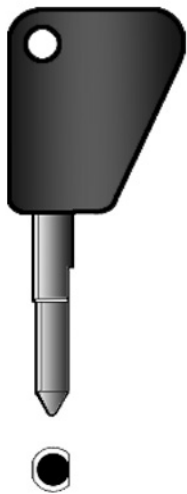

**CARAT/106**



**101/102  
103/104**



**EURO/ECO  
EASY/LUPO**

**OPTIONAL**

**MR30**

*Adattatori per chiavi Renault  
Adaptors for Renault keys  
Adapters für Renault-Schlüssel  
Adaptateurs pour clés Renault  
Adaptadores para llaves Renault*



TO FIT: **SAAB (S)**



**303/304/305**



**T-REX  
T-REX ADVANCE**



**PUNTO**

**STANDARD**



2.5 mm

**RIC01810B**

*Fresino HC011  
Cutter HC011  
Fräser HC011  
Fraise HC011  
Fresa HC011*



**RIC01811B**

*Tastatore C011  
Tracer Point C011  
Taster C011  
Palpeur C011  
Palpador C011*



STANDARD

**OPZ03182B**

Morsetto A-994  
Jaw A-994  
Spannbacke A-994  
Étau A-994  
Mordaza A-994



**994 LASER**



2.5 mm



**RIC05304B**

Fresino WC011A  
Cutter WC011A  
Fräser WC011A  
Fraise WC011A  
Fresa WC011A

STANDARD

**OPZ09734B**

Morsetto A/C - 997  
Jaw A/C - 997  
Spannbacke A/C - 997  
Étau A/C - 997  
Mordaza A/C - 997

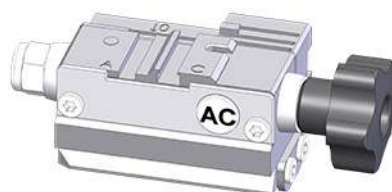

**NINJA LASER**



2.5 mm



**RIC05304B**

Fresino WC011A  
Cutter WC011A  
Fräser WC011A  
Fraise WC011A  
Fresa WC011A

STANDARD  
(VERSION 4 JAWS)



2.5 mm

**OPZ04871B**

Morsetto A01  
Jaw A01  
Spannbacke A01  
Étau A01  
Mordaza A01

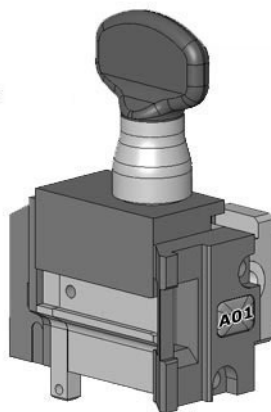

**NINJA VORTEX**

**RIC05048B**

Fresino V003  
Cutter V003  
Fräser V003  
Fraise V003  
Fresa V003



**VERSA**

STANDARD



2.5 mm

**OPZ10569B**

Morsetto C30  
Jaw C30  
Spannbacke C30  
Étau C30  
Mordaza C30



**NINJA TOTAL**

**RIC05048B**

Fresino V003  
Cutter V003  
Fräser V003  
Fraise V003  
Fresa V003





V66TK1

V66TK8

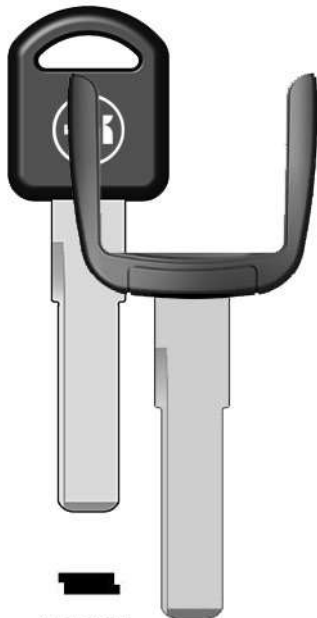

V66BP

V66TKU



303/304/305



PUNTO



T-REX  
T-REX ADVANCE

**OPTIONAL**

**MA**

Adattatori per chiavi VAG  
Adaptors for VAG keys  
Adapters für VAG-Schlüssel  
Adaptateurs pour clés VAG  
Adaptadores para llaves VAG



**STANDARD**

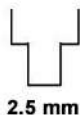

2.5 mm

**RIC01810B**  
Fresino HC011  
Cutter HC011  
Fräser HC011  
Fraise HC011  
Fresa HC011



**RIC01811B**  
Tastatore C011  
Tracer Point C011  
Taster C011  
Palpeur C011  
Palpador C011

**OPTIONAL**



3.0 mm

**RIC01715B**  
Fresino HC030  
Cutter HC030  
Fräser HC030  
Fraise HC030  
Fresa HC030



**RIC01716B**  
Tastatore C030  
Tracer Point C030  
Taster C030  
Palpeur C030  
Palpador C030

**STANDARD**



2,5 mm

**RIC01810B**  
Fresino HC011  
Cutter HC011  
Fräser HC011  
Fraise HC011  
Fresa HC011

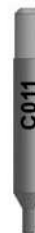

**RIC01811B**  
Tastatore C011  
Tracer Point C011  
Taster C011  
Palpeur C011  
Palpador C011

**OPTIONAL**



3,0 mm

**RIC01715B**  
Fresino HC030  
Cutter HC030  
Fräser HC030  
Fraise HC030  
Fresa HC030



**RIC01716B**  
Tastatore C030  
Tracer Point C030  
Taster C030  
Palpeur C030  
Palpador C030

STANDARD

**OPZ05223B**

Morsetto C-994  
Jaw C-994  
Spannbacke C-994  
Étau C-994  
Mordaza C-994



**994 LASER**



2.5 mm



**RIC05304B**

Fresino WC011A  
Cutter WC011A  
Fräser WC011A  
Fraise WC011A  
Fresa WC011A



STANDARD

**OPZ09734B**

Morsetto A/C - 997  
Jaw A/C - 997  
Spannbacke A/C - 997  
Étau A/C - 997  
Mordaza A/C - 997

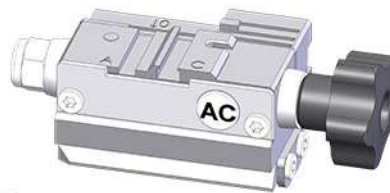

**NINJA LASER**

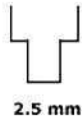

2.5 mm



**RIC05304B**

Fresino WC011A  
Cutter WC011A  
Fräser WC011A  
Fraise WC011A  
Fresa WC011A



V66TK1



V66TK8

STANDARD  
(VERSION 4 JAWS)



2.5 mm

**OPZ04875B**

Morsetto A03  
Jaw A03  
Spannbacke A03  
Étau A03  
Mordaza A03

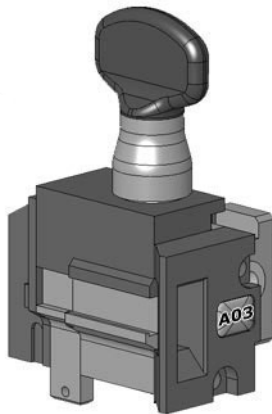

**NINJA TOTAL**



**NINJA VORTEX**



**VERSA**



**RIC05048B**

Fresino V003  
Cutter V003  
Fräser V003  
Fraise V003  
Fresa V003

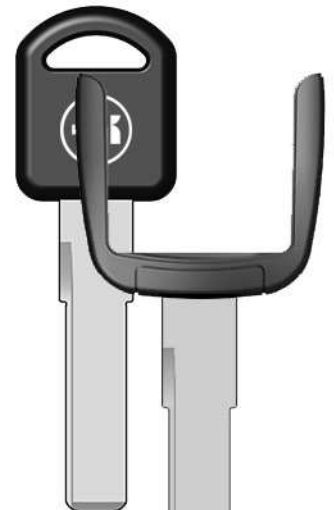

V66BP



V66TKU

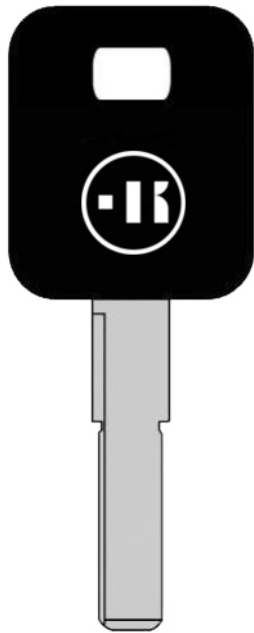

AD66TK1

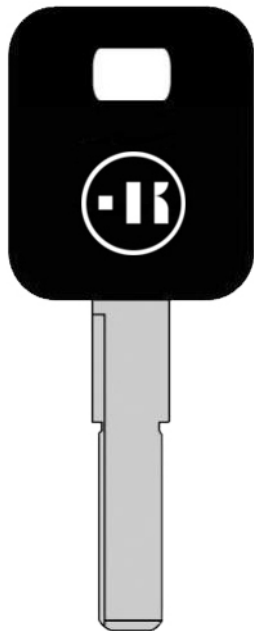

AD66TK8



303/304/305



PUNTO



T-REX  
T-REX ADVANCE

OPTIONAL

MA

Adattatori per chiavi VAG  
Adaptors for VAG keys  
Adapters für VAG-Schlüssel  
Adaptateurs pour clés VAG  
Adaptadores para llaves VAG



STANDARD



2.5 mm

**RIC01810B**  
Fresino HC011  
Cutter HC011  
Fräser HC011  
Fraise HC011  
Fresa HC011



**RIC01811B**  
Tastatore C011  
Tracer Point C011  
Taster C011  
Palpeur C011  
Palpador C011

OPTIONAL



3.0 mm

**RIC01715B**  
Fresino HC030  
Cutter HC030  
Fräser HC030  
Fraise HC030  
Fresa HC030



**RIC01716B**  
Tastatore C030  
Tracer Point C030  
Taster C030  
Palpeur C030  
Palpador C030

STANDARD



2,5 mm

**RIC01810B**  
Fresino HC011  
Cutter HC011  
Fräser HC011  
Fraise HC011  
Fresa HC011



**RIC01811B**  
Tastatore C011  
Tracer Point C011  
Taster C011  
Palpeur C011  
Palpador C011

OPTIONAL



3,0 mm

**RIC01715B**  
Fresino HC030  
Cutter HC030  
Fräser HC030  
Fraise HC030  
Fresa HC030



**RIC01716B**  
Tastatore C030  
Tracer Point C030  
Taster C030  
Palpeur C030  
Palpador C030

STANDARD

**OPZ05223B**

Morsetto C-994  
Jaw C-994  
Spannbacke C-994  
Étau C-994  
Mordaza C-994



**994 LASER**



2.5 mm



**RIC05304B**

Fresino WC011A  
Cutter WC011A  
Fräser WC011A  
Fraise WC011A  
Fresa WC011A

STANDARD

**OPZ09734B**

Morsetto A/C - 997  
Jaw A/C - 997  
Spannbacke A/C - 997  
Étau A/C - 997  
Mordaza A/C - 997

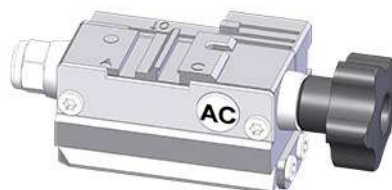

**NINJA LASER**



2.5 mm



**RIC05304B**

Fresino WC011A  
Cutter WC011A  
Fräser WC011A  
Fraise WC011A  
Fresa WC011A

STANDARD  
(VERSION 4 JAWS)



2.5 mm



**RIC05048B**

Fresino V003  
Cutter V003  
Fräser V003  
Fraise V003  
Fresa V003

**OPZ04875B**

Morsetto A03  
Jaw A03  
Spannbacke A03  
Étau A03  
Mordaza A03

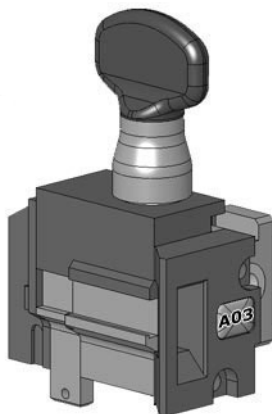

**NINJA TOTAL**



**NINJA VORTEX**



**VERSA**

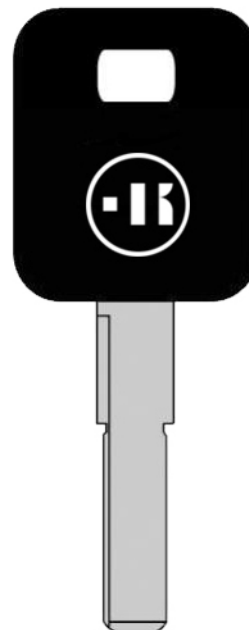

**AD66TK1**

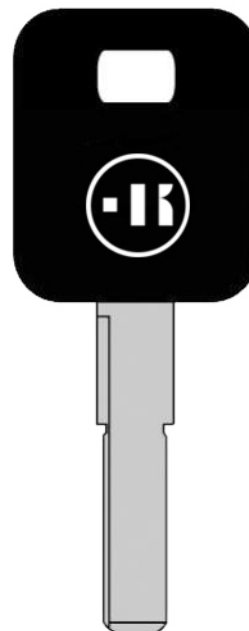

**AD66TK8**



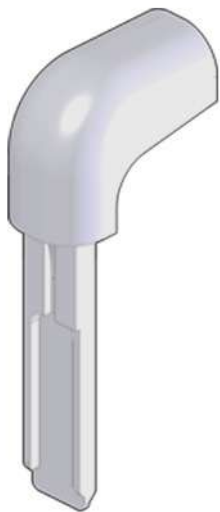

EMERGENCY KEY



994 LASER

**OPZ03182B**  
 Morsetto A-994  
 Jaw A-994  
 Spannbacke A-994  
 Étau A-994  
 Mordaza A-994  
**STANDARD**



**OPZ05223B**  
 Morsetto C-994  
 Jaw C-994  
 Spannbacke C-994  
 Étau C-994  
 Mordaza C-994  
**STANDARD**



**OPZ07885B**  
 Adattatore AD03 per chiavi Lexus  
 Adaptor AD03 for Lexus keys  
 Adapter AD03 für Lexus-Schlüssel  
 Adaptateur AD03 pour clés Lexus  
 Adaptador AD03 para llaves Lexus  
**OPTIONAL**



**RIC05304B**  
 Fresino WC011A  
 Cutter WC011A  
 Fräser WC011A  
 Fraise WC011A  
 Fresa WC011A  
**STANDARD**



NINJA LASER

**OPZ09734B**  
 Morsetto A/C - 997  
 Jaw A/C - 997  
 Spannbacke A/C - 997  
 Étau A/C - 997  
 Mordaza A/C - 997  
**STANDARD**



**OPZ07885B**  
 Adattatore AD03 per chiavi Lexus  
 Adaptor AD03 for Lexus keys  
 Adapter AD03 für Lexus-Schlüssel  
 Adaptateur AD03 pour clés Lexus  
 Adaptador AD03 para llaves Lexus  
**OPTIONAL**



**RIC05304B**  
 Fresino WC011A  
 Cutter WC011A  
 Fräser WC011A  
 Fraise WC011A  
 Fresa WC011A  
**STANDARD**



NINJA VORTEX



**OPZ10631B**  
 Adattatore AD06  
 Adaptor AD06  
 Adapter AD06  
 Adaptateur AD06  
 Adaptador AD06  
**OPTIONAL**



**RIC05048B**  
 Fresino V003  
 Cutter V003  
 Fräser V003  
 Fraise V003  
 Fresa V003  
**STANDARD**  
 (VERSION 4 JAWS)



**OPZ04871B**  
 Morsetto A01  
 Jaw A01  
 Spannbacke A01  
 Étau A01  
 Mordaza A01  
**STANDARD**  
 (VERSION 4 JAWS)

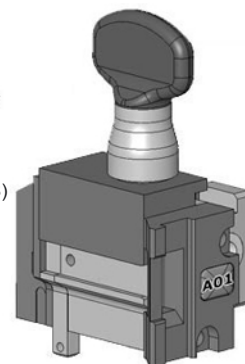

VERSA

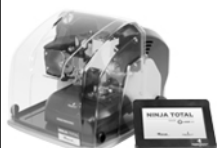

NINJA TOTAL



**OPZ10631B**  
 Adattatore AD06  
 Adaptor AD06  
 Adapter AD06  
 Adaptateur AD06  
 Adaptador AD06  
**OPTIONAL**



**RIC05048B**  
 Fresino V003  
 Cutter V003  
 Fräser V003  
 Fraise V003  
 Fresa V003  
**STANDARD**

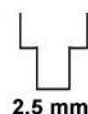

**OPZ10569B**  
 Morsetto C30  
 Jaw C30  
 Spannbacke C30  
 Étau C30  
 Mordaza C30  
**STANDARD**



STANDARD



2.5 mm

**RIC01810B**  
Fresino HC011  
Cutter HC011  
Fräser HC011  
Fraise HC011  
Fresa HC011



**RIC01811B**  
Tastatore C011  
Tracer Point C011  
Taster C011  
Palpeur C011  
Palpador C011



**303/304/305**



**T-REX  
T-REX ADVANCE**



**PUNTO**



STANDARD

**OPZ03182B**  
Morsetto A-994  
Jaw A-994  
Spannbacke A-994  
Étau A-994  
Mordaza A-994



2.5 mm



**RIC05304B**  
Fresino WC011A  
Cutter WC011A  
Fräser WC011A  
Fraise WC011A  
Fresa WC011A



**994 LASER**



**TR48TK TR49P**

STANDARD

**OPZ09734B**  
Morsetto A/C - 997  
Jaw A/C - 997  
Spannbacke A/C - 997  
Étau A/C - 997  
Mordaza A/C - 997

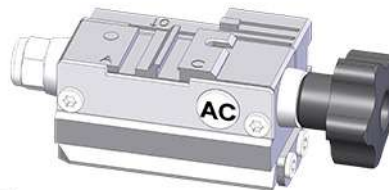

2.5 mm



**RIC05304B**  
Fresino WC011A  
Cutter WC011A  
Fräser WC011A  
Fraise WC011A  
Fresa WC011A



**NINJA LASER**



**TR49BTK3**



TR48TK TR49P



TR49BTK3



**NINJA VORTEX**



**VERSA**



**NINJA TOTAL**

**STANDARD**  
(VERSION 4 JAWS)



2.5 mm



**RIC05048B**  
Fresino V003  
Cutter V003  
Fräser V003  
Fraise V003  
Fresa V003

**OPZ04871B**  
Morsetto A01  
Jaw A01  
Spannbacke A01  
Étau A01  
Mordaza A01

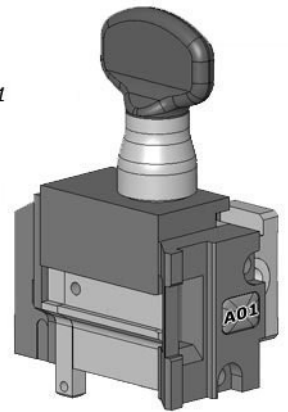

**STANDARD**



2.5 mm



**RIC05048B**  
Fresino V003  
Cutter V003  
Fräser V003  
Fraise V003  
Fresa V003

**OPZ10569B**  
Morsetto C30  
Jaw C30  
Spannbacke C30  
Étau C30  
Mordaza C30



**OPZ03182B**  
Morsetto A-994  
Jaw A-994  
Spannbacke A-994  
Étau A-994  
Mordaza A-994  
**STANDARD**



**OPZ05223B**  
Morsetto C-994  
Jaw C-994  
Spannbacke C-994  
Étau C-994  
Mordaza C-994  
**STANDARD**



**RIC05304B**  
Fresino WC011A  
Cutter WC011A  
Fräser WC011A  
Fraise WC011A  
Fresa WC011A  
**STANDARD**



**994 LASER**



**OPZ07885B**

Adattatore AD03 per chiavi Lexus  
Adaptor AD03 for Lexus keys  
Adapter AD03 für Lexus-Schlüssel  
Adaptateur AD03 pour clés Lexus  
Adaptador AD03 para llaves Lexus  
**OPTIONAL**

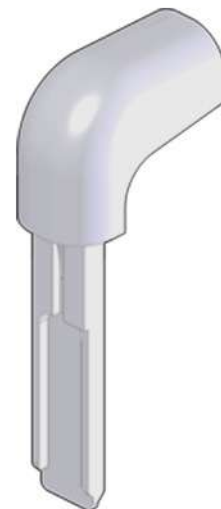

**EMERGENCY KEY**

**OPZ09734B**  
Morsetto A/C - 997  
Jaw A/C - 997  
Spannbacke A/C - 997  
Étau A/C - 997  
Mordaza A/C - 997  
**STANDARD**

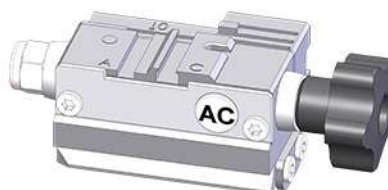

**NINJA LASER**



**OPZ07885B**

Adattatore AD03 per chiavi Lexus  
Adaptor AD03 for Lexus keys  
Adapter AD03 für Lexus-Schlüssel  
Adaptateur AD03 pour clés Lexus  
Adaptador AD03 para llaves Lexus  
**OPTIONAL**

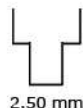

**RIC05304B**  
Fresino WC011A  
Cutter WC011A  
Fräser WC011A  
Fraise WC011A  
Fresa WC011A  
**STANDARD**



**OPZ04871B**  
Morsetto A01  
Jaw A01  
Spannbacke A01  
Étau A01  
Mordaza A01  
**STANDARD**  
(VERSION 4 JAWS)

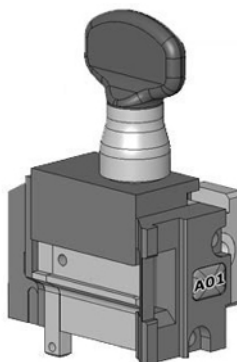

**NINJA VORTEX**



**OPZ10631B**

Adattatore AD06  
Adaptor AD06  
Adapter AD06  
Adaptateur AD06  
Adaptador AD06  
**OPTIONAL**



**RIC05048B**  
Fresino V003  
Cutter V003  
Fräser V003  
Fraise V003  
Fresa V003  
**STANDARD**  
(VERSION 4 JAWS)

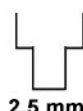

**VERSA**

**OPZ10569B**  
Morsetto C30  
Jaw C30  
Spannbacke C30  
Étau C30  
Mordaza C30  
**STANDARD**



**NINJA TOTAL**



**OPZ10631B**

Adattatore AD06  
Adaptor AD06  
Adapter AD06  
Adaptateur AD06  
Adaptador AD06  
**OPTIONAL**



**RIC05048B**  
Fresino V003  
Cutter V003  
Fräser V003  
Fraise V003  
Fresa V003  
**STANDARD**

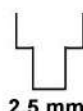





V66TK1

V66TK8

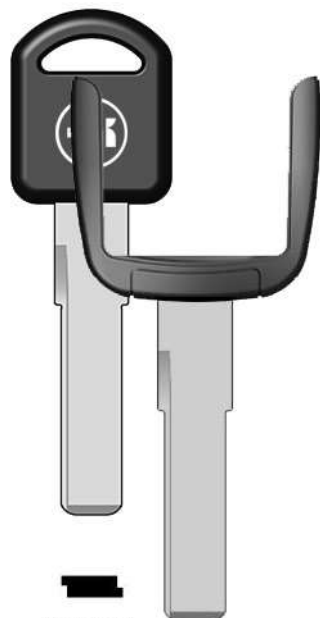

V66BP

V66TKU



303/304/305



PUNTO



T-REX  
T-REX ADVANCE

OPTIONAL

MA

Adattatori per chiavi VAG  
Adaptors for VAG keys  
Adapters für VAG-Schlüssel  
Adaptateurs pour clés VAG  
Adaptadores para llaves VAG



STANDARD

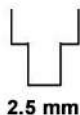

2.5 mm

**RIC01810B**  
Fresino HC011  
Cutter HC011  
Fräser HC011  
Fraise HC011  
Fresa HC011



**RIC01811B**  
Tastatore C011  
Tracer Point C011  
Taster C011  
Palpeur C011  
Palpador C011

OPTIONAL



3.0 mm

**RIC01715B**  
Fresino HC030  
Cutter HC030  
Fräser HC030  
Fraise HC030  
Fresa HC030



**RIC01716B**  
Tastatore C030  
Tracer Point C030  
Taster C030  
Palpeur C030  
Palpador C030

STANDARD



2,5 mm

**RIC01810B**  
Fresino HC011  
Cutter HC011  
Fräser HC011  
Fraise HC011  
Fresa HC011

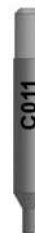

**RIC01811B**  
Tastatore C011  
Tracer Point C011  
Taster C011  
Palpeur C011  
Palpador C011

OPTIONAL

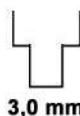

3,0 mm

**RIC01715B**  
Fresino HC030  
Cutter HC030  
Fräser HC030  
Fraise HC030  
Fresa HC030



**RIC01716B**  
Tastatore C030  
Tracer Point C030  
Taster C030  
Palpeur C030  
Palpador C030



TO  
FIT :

# VOLKSWAGEN (D)

## STANDARD

### OPZ05223B

Morsetto C-994  
Jaw C-994  
Spannbacke C-994  
Étau C-994  
Mordaza C-994



2.5 mm



### RIC05304B

Fresino WC011A  
Cutter WC011A  
Fräser WC011A  
Fraise WC011A  
Fresa WC011A



### 994 LASER



## STANDARD

### OPZ09734B

Morsetto A/C - 997  
Jaw A/C - 997  
Spannbacke A/C - 997  
Étau A/C - 997  
Mordaza A/C - 997

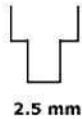
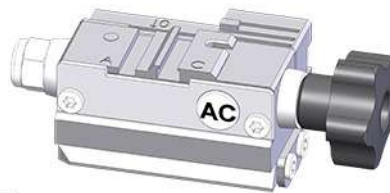

2.5 mm



### RIC05304B

Fresino WC011A  
Cutter WC011A  
Fräser WC011A  
Fraise WC011A  
Fresa WC011A



### NINJA LASER



V66TK1



V66TK8

## STANDARD (VERSION 4 JAWS)



2.5 mm



### RIC05048B

Fresino V003  
Cutter V003  
Fräser V003  
Fraise V003  
Fresa V003

### OPZ04875B

Morsetto A03  
Jaw A03  
Spannbacke A03  
Étau A03  
Mordaza A03

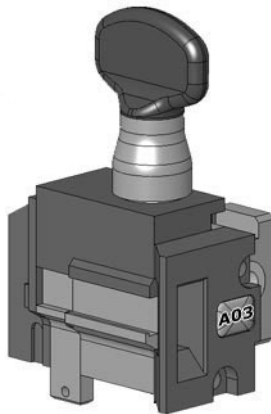

### NINJA TOTAL



### NINJA VORTEX



### VERSA

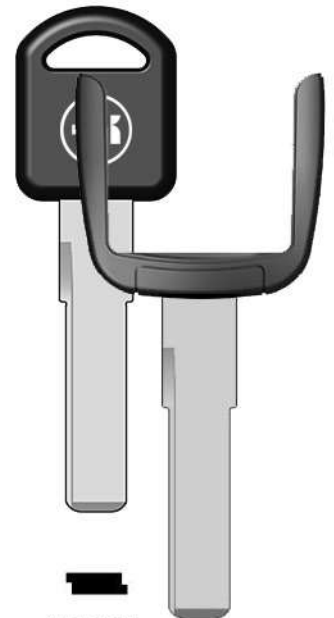

V66BP



V66TKU



**HU162U**



**303/304/305**

**T-REX  
T-REX ADVANCE**

**PUNTO**

**OPTIONAL**



1.5 mm

**RIC01812B**  
Fresino HC023  
Cutter HC023  
Fräser HC023  
Fraise HC023  
Fresa HC023



**RIC01813B**  
Tastatore C023  
Tracer Point C023  
Taster C023  
Palpeur C023  
Palpador C023



**NINJA LASER**

**994 LASER**

**OPTIONAL**

**OPZ10260B**  
Morsetto V per chiavi Volkswagen  
Jaw V for Volkswagen keys  
Spannbacke V für Volkswagen-Schlüssel  
Étau V pour clés Volkswagen  
Mordaza V para llaves Volkswagen



**RIC09617B**  
Fresino CL005  
Cutter CL005  
Fräser CL005  
Fraise CL005  
Fresa CL005



1,5 mm



**NINJA TOTAL**

**NINJA VORTEX**

**VERSA**

**OPTIONAL**



1.5 mm



**RIC05274B**  
Fresino V012  
Cutter V012  
Fräser V012  
Fraise V012  
Fresa V012

**OPZ10618B**  
Morsetto A13  
Jaw A13  
Spannbacke A13  
Étau A13  
Mordaza A13

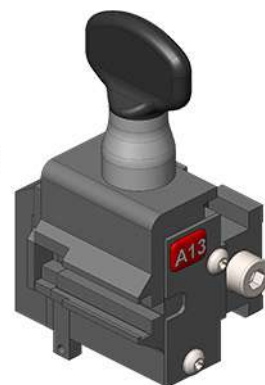

OPTIONAL



1.5 mm

**RIC01812B**  
Fresino HC023  
Cutter HC023  
Fräser HC023  
Fraise HC023  
Fresa HC023



**RIC01813B**  
Tastatore C023  
Tracer Point C023  
Taster C023  
Palpeur C023  
Palpador C023



**303/304/305**



**T-REX  
T-REX ADVANCE**



**PUNTO**



**994 LASER**



**HU163SU**

**OPZ05223B**

Morsetto C-994  
Jaw C-994  
Spannbacke C-994  
Étau C-994  
Mordaza C-994

**STANDARD**



**RIC09617B**  
Fresino CL005  
Cutter CL005  
Fräser CL005  
Fraise CL005  
Fresa CL005  
**OPTIONAL**



1,5 mm

**OPZ09734B**

Morsetto A/C - 997  
Jaw A/C - 997  
Spannbacke A/C - 997  
Étau A/C - 997  
Mordaza A/C - 997

**STANDARD**

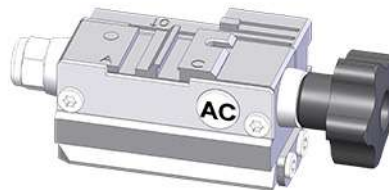

**RIC09617B**  
Fresino CL005  
Cutter CL005  
Fräser CL005  
Fraise CL005  
Fresa CL005  
**OPTIONAL**



1,5 mm



**NINJA LASER**



  
HU163SU



**NINJA TOTAL**



**NINJA VORTEX**



**VERSA**



1.5 mm



**RIC05274B**  
Fresino V012  
Cutter V012  
Fräser V012  
Fraise V012  
Fresa V012  
**OPTIONAL**

**OPZ04875B**  
Morsetto A03  
Jaw A03  
Spannbacke A03  
Étau A03  
Mordaza A03  
**STANDARD**  
(VERSION 4 JAWS)

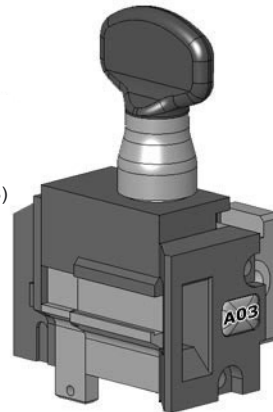

STANDARD



2.5 mm

**RIC01810B**  
Fresino HC011  
Cutter HC011  
Fräser HC011  
Fraise HC011  
Fresa HC011



**RIC01811B**  
Tastatore C011  
Tracer Point C011  
Taster C011  
Palpeur C011  
Palpador C011



**303/304/305**



**T-REX  
T-REX ADVANCE**



**PUNTO**

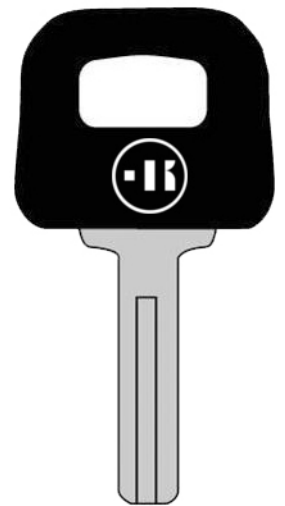

VL17P

STANDARD

**OPZ03182B**  
Morsetto A-994  
Jaw A-994  
Spannbacke A-994  
Étau A-994  
Mordaza A-994



2.5 mm



**RIC05304B**  
Fresino WC011A  
Cutter WC011A  
Fräser WC011A  
Fraise WC011A  
Fresa WC011A



**994 LASER**

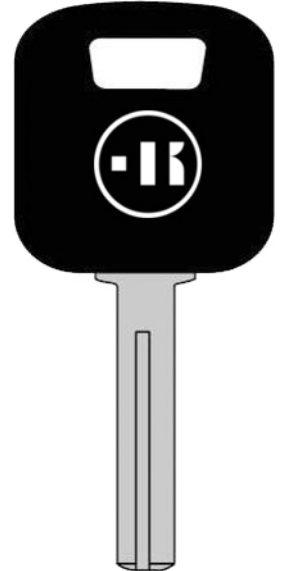

VL17TK1

STANDARD

**OPZ09734B**  
Morsetto A/C - 997  
Jaw A/C - 997  
Spannbacke A/C - 997  
Étau A/C - 997  
Mordaza A/C - 997

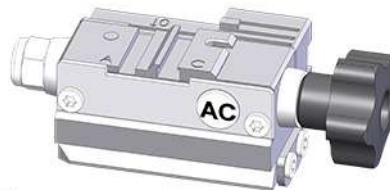

2.5 mm



**RIC05304B**  
Fresino WC011A  
Cutter WC011A  
Fräser WC011A  
Fraise WC011A  
Fresa WC011A



**NINJA LASER**

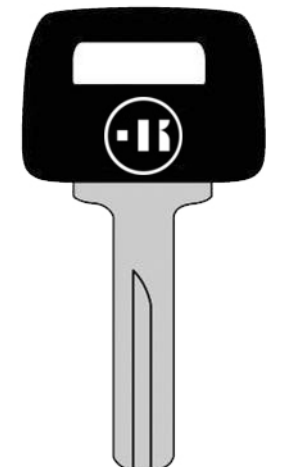

VL18P



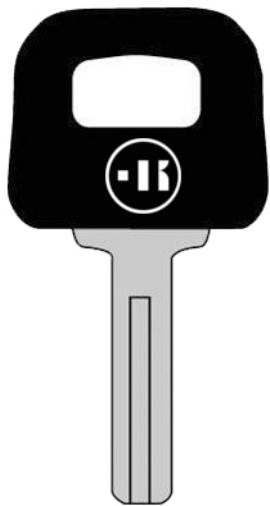

**H**  
VL17P

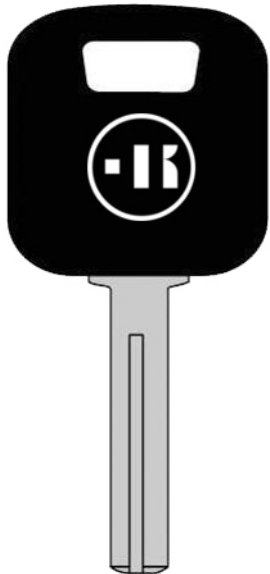

**H**  
VL17TK1

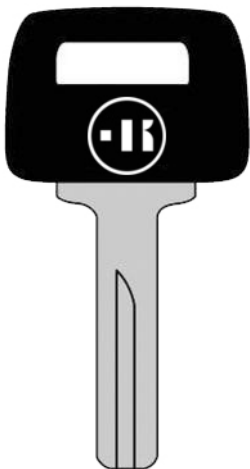

**N**  
VL18P



**NINJA VORTEX**



**VERSA**



**NINJA TOTAL**

**STANDARD**  
(VERSION 4 JAWS)



2.5 mm



**RIC05048B**  
Fresino V003  
Cutter V003  
Fräser V003  
Fraise V003  
Fresa V003

**OPZ04871B**  
Morsetto A01  
Jaw A01  
Spannbacke A01  
Étau A01  
Mordaza A01

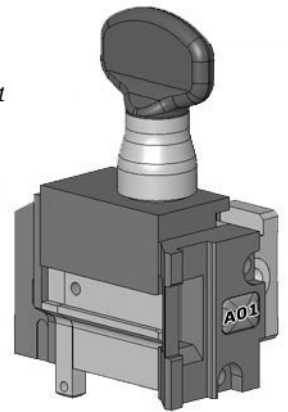

**STANDARD**



2.5 mm



**RIC05048B**  
Fresino V003  
Cutter V003  
Fräser V003  
Fraise V003  
Fresa V003

**OPZ10569B**  
Morsetto C30  
Jaw C30  
Spannbacke C30  
Étau C30  
Mordaza C30

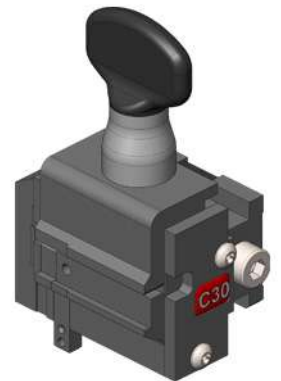

STANDARD



2.5 mm

**RIC01810B**  
Fresino HC011  
Cutter HC011  
Fräser HC011  
Fraise HC011  
Fresa HC011



**RIC01811B**  
Tastatore C011  
Tracer Point C011  
Taster C011  
Palpeur C011  
Palpador C011



**303/304/305**



**T-REX  
T-REX ADVANCE**



**PUNTO**

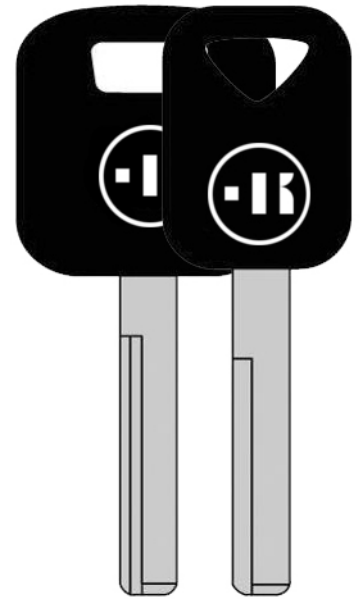

STANDARD

**OPZ03183B**  
Morsetto B-994  
Jaw B-994  
Spannbacke B-994  
Étau B-994  
Mordaza B-994



2.5 mm



**RIC05304B**  
Fresino WC011A  
Cutter WC011A  
Fräser WC011A  
Fraise WC011A  
Fresa WC011A



**994 LASER**



VL15TK1 VL16P

STANDARD

**OPZ09781B**  
Morsetto B - 997  
Jaw B - 997  
Spannbacke B - 997  
Étau B - 997  
Mordaza B - 997



2.5 mm



**RIC05304B**  
Fresino WC011A  
Cutter WC011A  
Fräser WC011A  
Fraise WC011A  
Fresa WC011A



**NINJA LASER**

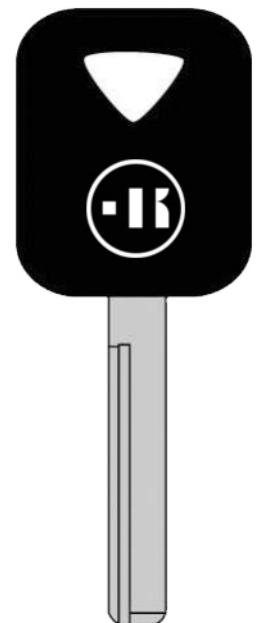

VL15P

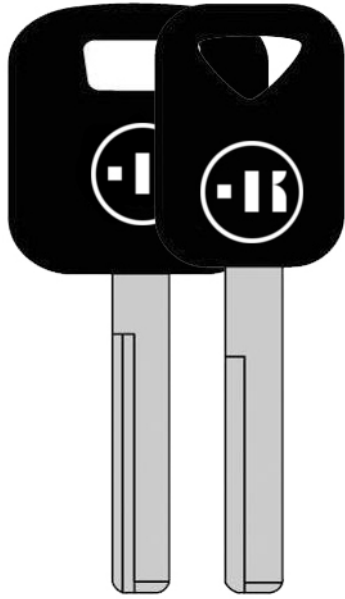

VL15TK1 VL16P

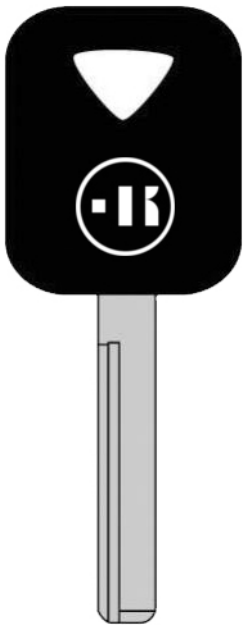

VL15P



**NINJA TOTAL**



**NINJA VORTEX**



**VERSA**

**STANDARD**  
(VERSION 4 JAWS)



2.5 mm

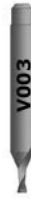

**RIC05048B**  
Fresino V003  
Cutter V003  
Fräser V003  
Fraise V003  
Fresa V003

**OPZ04873B**  
Morsetto A02  
Jaw A02  
Spannbacke A02  
Étau A02  
Mordaza A02

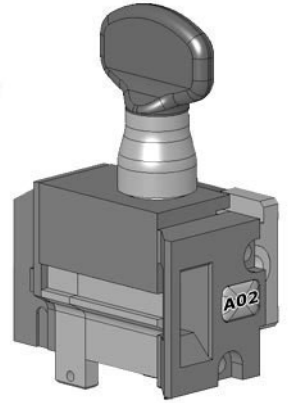

**STANDARD**



2.5 mm

**RIC01810B**  
Fresino HC011  
Cutter HC011  
Fräser HC011  
Fraise HC011  
Fresa HC011



**RIC01811B**  
Tastatore C011  
Tracer Point C011  
Taster C011  
Palpeur C011  
Palpador C011



**303/304/305**



**T-REX  
T-REX ADVANCE**



**PUNTO**



**ZAD30U**

**OPZ03182B**  
Morsetto A-994  
Jaw A-994  
Spannbacke A-994  
Étau A-994  
Mordaza A-994  
**STANDARD**



**994 LASER**



**OPZ09329B**  
Adattatore AV08  
Adaptor AV08  
Adapter AV08  
Adaptateur AV08  
Adaptador AV08  
**OPTIONAL**

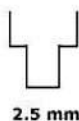

2.5 mm



**RIC05304B**  
Fresino WC011A  
Cutter WC011A  
Fräser WC011A  
Fraise WC011A  
Fresa WC011A  
**STANDARD**

**OPZ09734B**  
Morsetto A/C - 997  
Jaw A/C - 997  
Spannbacke A/C - 997  
Étau A/C - 997  
Mordaza A/C - 997  
**STANDARD**

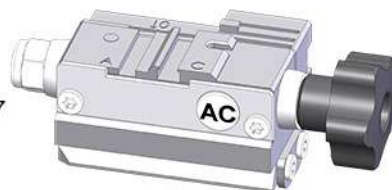

**NINJA LASER**



**OPZ09329B**  
Adattatore AV08  
Adaptor AV08  
Adapter AV08  
Adaptateur AV08  
Adaptador AV08  
**OPTIONAL**

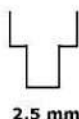

2.5 mm



**RIC05304B**  
Fresino WC011A  
Cutter WC011A  
Fräser WC011A  
Fraise WC011A  
Fresa WC011A  
**STANDARD**



ZAD30U



**NINJA VORTEX**



**VERSA**



**NINJA TOTAL**



**OPZ09329B**  
*Adattatore AV08*  
*Adaptor AV08*  
*Adapter AV08*  
*Adaptateur AV08*  
*Adaptador AV08*  
**OPTIONAL**

**OPZ04871B**  
*Morsetto A01*  
*Jaw A01*  
*Spannbacke A01*  
*Étau A01*  
*Mordaza A01*  
**STANDARD**  
 (VERSION 4 JAWS)

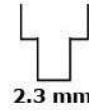
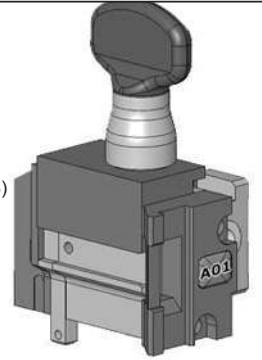

**RIC05506B**  
*Fresino V016*  
*Cutter V016*  
*Fräser V016*  
*Fraise V016*  
*Fresa V016*  
**OPTIONAL**



**OPZ09329B**  
*Adattatore AV08*  
*Adaptor AV08*  
*Adapter AV08*  
*Adaptateur AV08*  
*Adaptador AV08*  
**OPTIONAL**

**OPZ10569B**  
*Morsetto C30*  
*Jaw C30*  
*Spannbacke C30*  
*Étau C30*  
*Mordaza C30*  
**STANDARD**

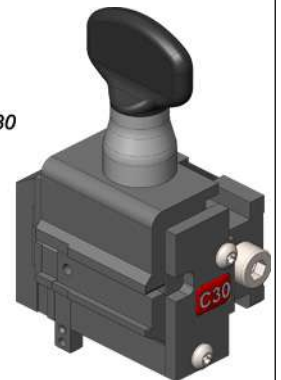

**RIC05506B**  
*Fresino V016*  
*Cutter V016*  
*Fräser V016*  
*Fraise V016*  
*Fresa V016*  
**OPTIONAL**



**CHIAVI PATENT / CHIAVI A DOPPIA MAPPA E POMPA**

---

**COLD FORGED KEYS / DOUBLE BIT AND PUMP KEYS**

---

**PATENTSCHLÜSSEL / DOPPELBART - PUMPENSCHLÜSSEL**

---

**CLÉS PATENT / CLÉS À DOUBLE PANNETON ET À POMPE**

---

**LLAVES PATENT / LLAVES A DOBLE PALETÓN Y POMPA**

---

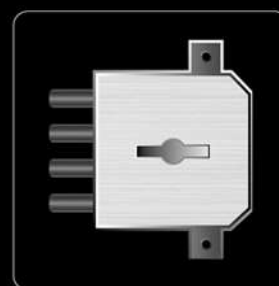

TO FIT: **CHIAVI FERMO POSTERIORE - BACK STOP BIT KEYS**

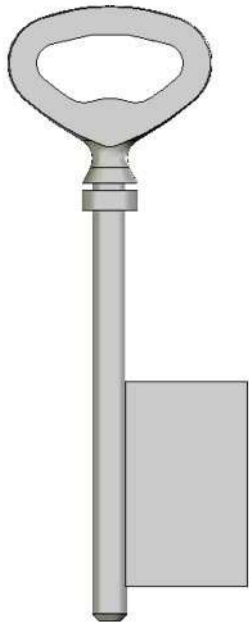

**POWER LYNX  
SIGMA PRO**

**OPTIONAL**

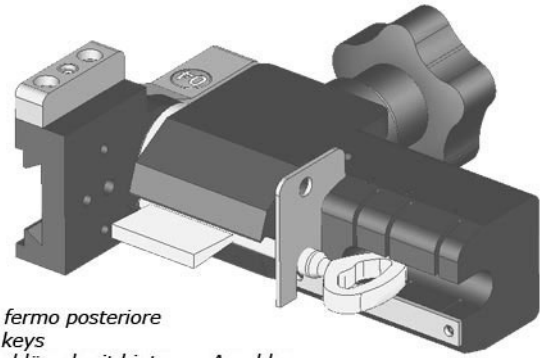

**OPZ04701B**

*Morsetto per chiavi a fermo posteriore  
Jaw for back stop bit keys  
Spannbacke für Bartschlüssel mit hinterem Anschlag  
Étau pour clés panneton à butee derriere  
Mordaza para llaves de pala con tope posterior*

TO FIT: **TOVER (E)**



**POWER LYNX  
SIGMA PRO**

**OPTIONAL**

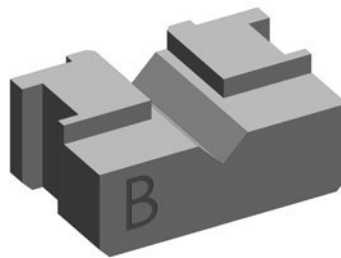

**OPZ08313B**

*Ganascia B per Tover  
Vice B for Tover  
Schraubstock B für Tover  
Mâchoire B pour Tover  
Morsa B para Tover*

TO  
FIT :

FIAM (I)

**OPTIONAL**

**OPZ04089B**

Adattatore per chiavi gambo quadro  
Adaptor for stem squared keys  
Adapter für schlüssel mit viereckiger schaft  
Adaptateur pour clés avec tige carrée  
Adaptador para llaves con vástago cuadrado

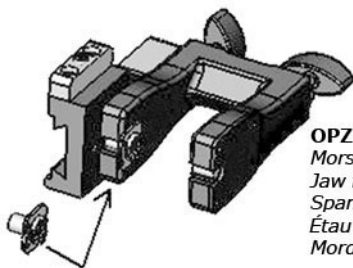
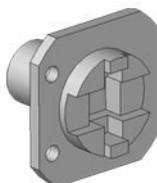

**OPZ04061B**

Morsetto per chiavi mappa fermo anteriore  
Jaw for front stop bit keys  
Spannbacke für bartschlüssel mit vorderem anschlag  
Étau pour clés panneton à butée avant  
Mordaza para llaves de pala con tope anterior



**POWER LYNX  
SIGMA PRO**

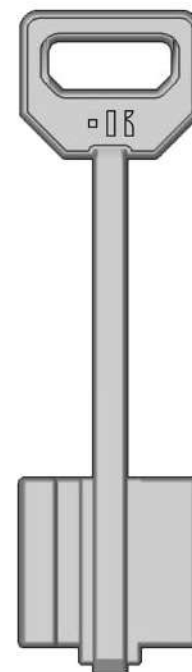

15FIA

TO  
FIT :

KROMER (D)

**OPTIONAL**

**OPZ05033B**

Morsetto 06 per chiavi Germania  
Jaw 06 for Germany keys  
Spannbacke 06 für Deutschland-Schlüssel  
Étau 06 pour clés Allemaïne  
Mordaza 06 para llaves Alemania

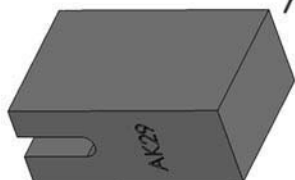
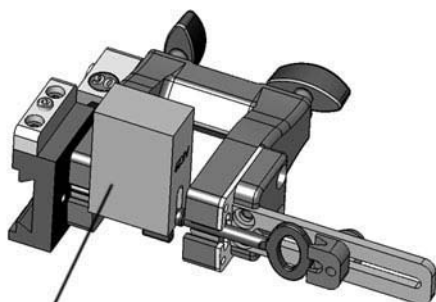

**OPZ05233B**

Adattatore 06 per chiavi Germania  
Adaptor 06 for Germany keys  
Adapter 06 für Deutschland-Schlüssel  
Adaptateur 06 pour clés Allemaïne  
Adaptador 06 para llaves Alemania



**POWER LYNX  
SIGMA PRO**



LONG

SHORT

TO FIT: **CHIAVI MAPPA - GERMANY KEYS**

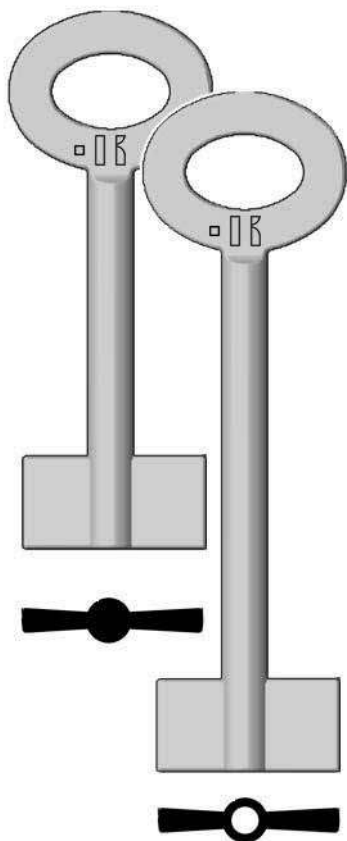

**POWER LYNX  
SIGMA PRO**

**OPTIONAL**

**OPZ05033B**

*Morsetto 06 per chiavi Germania  
Jaw 06 for Germany keys  
Spannbacke 06 für Deutschland-Schlüssel  
Étau 06 pour clés Allemaine  
Mordaza 06 para llaves Alemania*

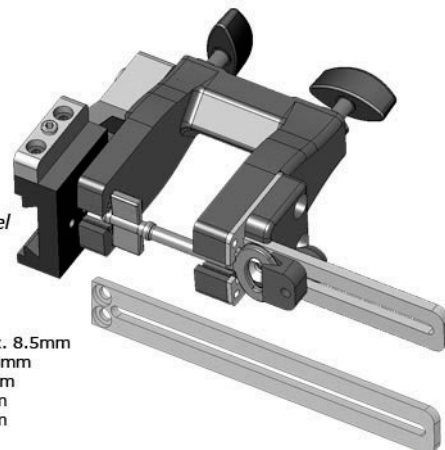

Gambo chiave Ø min. 5mm max. 8.5mm  
Key stem Ø min. 5mm max. 8.5mm  
Rücken Ø min. 5mm max. 8.5mm  
Canon Ø min. 5mm max. 8.5mm  
Cañon Ø min. 5mm max. 8.5mm

TO FIT: **CHIAVI FERMO CENTRALE - MORTICE KEYS**

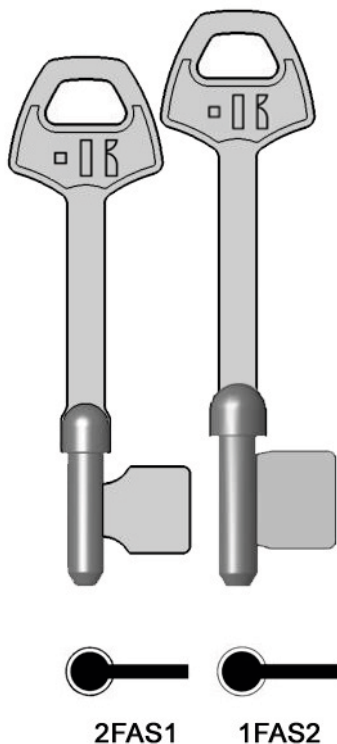

**POWER LYNX  
SIGMA PRO**

**OPTIONAL**

**OPZ04057B**

*Morsetto chiavi a mappa fermo centrale  
Jaw for mortice keys  
Spannbacke für Schlüssel mit Anschlag in der mitte  
Étau pour clés panneton à butée centrale  
Mordaza para llaves de pala con tope central*

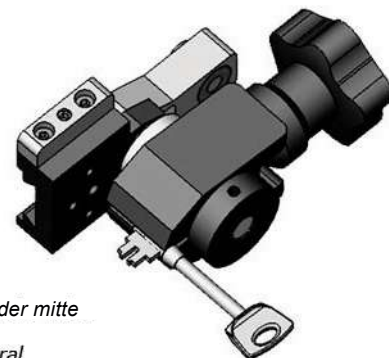

**STANDARD**



**206**

2FAS1

1FAS2

TO  
FIT :

PATENT

**OPTIONAL**

**CTV**

*Carrello tagli verticali  
Carriage for vertical cuts  
Nutenschneider  
Chariot pour coupes verticales  
Carro para los cortes verticales*



**T/CTV**

*Tastatore per carrello CTV  
Tracer Point for carriage CTV  
Taster für Nutenschneider CTV  
Palpeur pour le chariot CTV  
Palpador para el carro CTV*



**202**



**203**

**STANDARD**



**204**

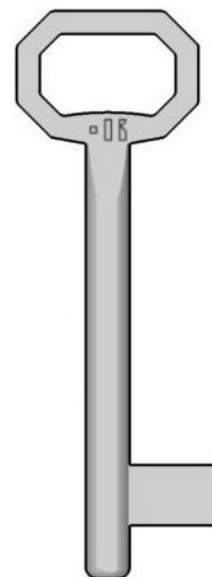

**PAT1**



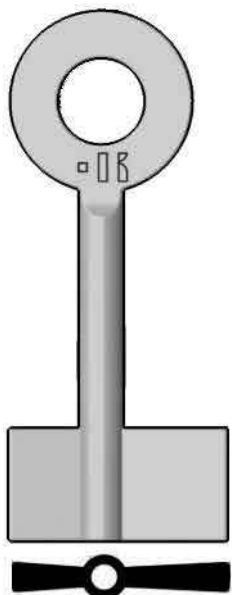

**FCF70PA**

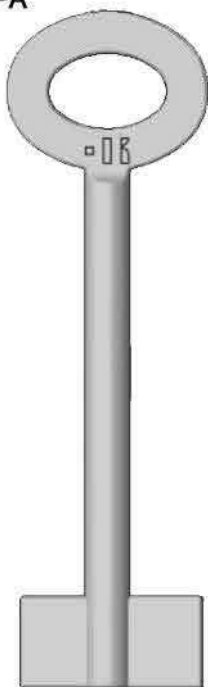

**FCF88CO**



**FCF455**



**POWER LYNX**



**SIGMA PRO**

**OPTIONAL**

**OPZ04353B**

*Set contropunte per chiavi femmina e chiavi corte  
Tailstocks set for pipe and short keys  
Reitstock für gebohrt-und Kurzschlüssel  
Contrepoints pour clés femelles et courtes  
Contrapuntas para llaves hembras y cortas*

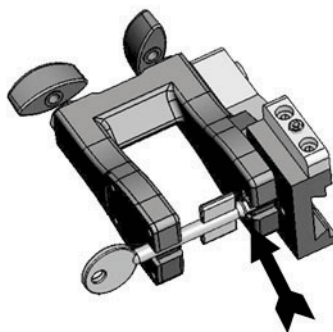
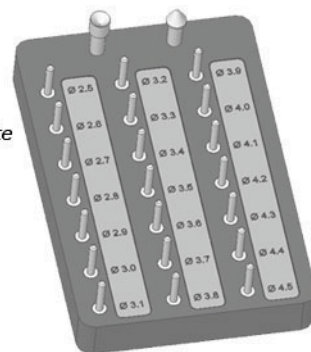

**OPZ04061B**

*Morsetto per chiavi mappa fermo anteriore  
Jaw for front stop bit keys  
Spannbacke für bartschlüssel mit vorderem anschlag  
Étau pour clés panneton à butée avant  
Mordaza para llaves de pala con tope anterior*

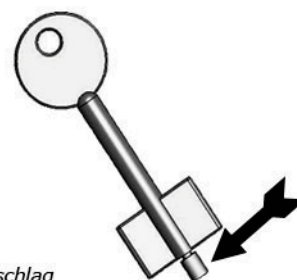

**OPZ04403B**

*Contropunta per chiavi femmina e chiavi corte  
Tailstock for pipe and short keys  
Reitstock für gebohrt und Kurzschlüssel  
Contrepoint pour clés femelles et courtes  
Contrapunta para llaves hembras y cortas  
**STANDARD***

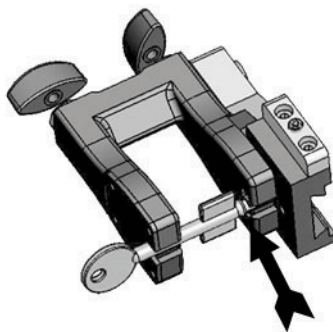

**OPZ04061B**

*Morsetto per chiavi mappa fermo anteriore  
Jaw for front stop bit keys  
Spannbacke für bartschlüssel mit vorderem anschlag  
Étau pour clés panneton à butée avant  
Mordaza para llaves de pala con tope anterior*

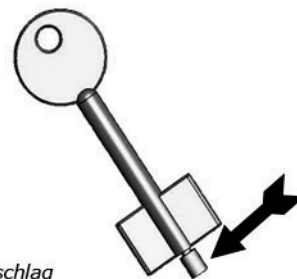

**OPTIONAL**

TO  
FIT :

# CHIAVI A POMPA - PUMP KEYS

**OPTIONAL**

**OPZ03014B**

Morsetto chiavi a pompa  
Jaw for pump keys  
Spannbacke für Pumpenschüssel  
Étau pour clés à pompe  
Mordaza para llaves de bomba

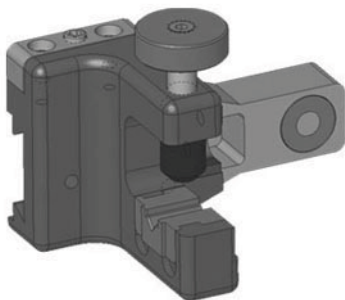

**POWER LYNX  
SIGMA PRO**

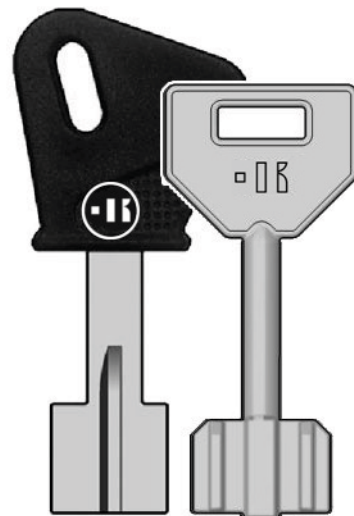

MO-FP  
MO-AP  
MO-CP  
MO-EP  
MO-GP



3FEB

TO  
FIT :

# SANS SOUCI (F)

**OPTIONAL**

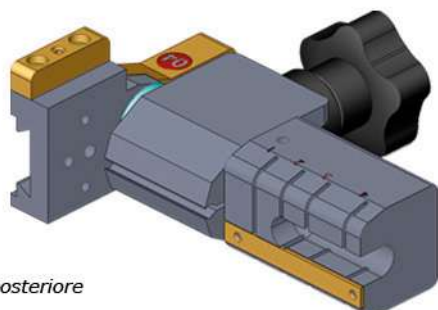

**OPZ04701B**

Morsetto per chiavi a mappa fermo posteriore  
Jaw for back stop bit keys  
Spannbacke für Bartschüssel mit hinterem Anschlag  
Étau pour clés panneton à butée derrière  
Mordaza para llaves de pala con tope posterior



**POWER LYNX  
SIGMA PRO**

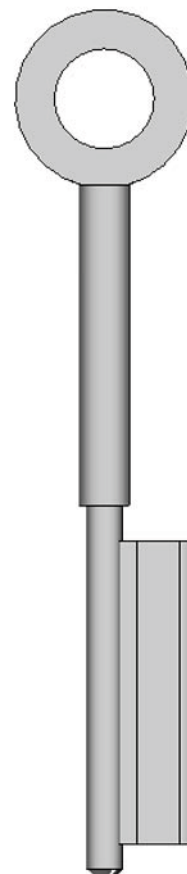

**CHIAVI A CROCE / PER CASELLARI POSTALI / TUBOLARI**

---

**CRUCIFORM KEYS / MAIL BOX KEYS / TUBULAR KEYS**

---

**KREUZBARTSCHLÜSSEL / POSTFACHSCHLÜSSEL / STECKSCHLÜSSEL**

---

**CLÉS A CRUCIFORMES / POUR CASIERS POSTAUX / TUBULAIRES**

---

**LLAVES A CRUZ / PARA CASILLAS POSTALES / TUBULARES**

---



TO  
FIT :

BILMA (E)

**OPTIONAL**

**OPZ08575B**

Morsetto KT0  
Jaw KT0  
Spannbacke KT0  
Étau KT0  
Mordaza KT0

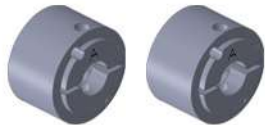

**OPZ09448B**

Adattatori modello A per chiavi Ø=10 mm  
Adaptors model A for keys Ø=10 mm  
Adapters model A für Schlüssel Ø=10 mm  
Adaptateurs catégorie A pour clés Ø=10 mm  
Adaptadores modelo/tipo A para llaves Ø=10 mm



**ARCADIA**

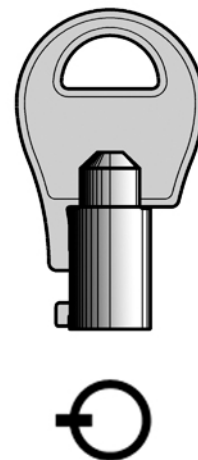

TO  
FIT :

CAVITH (F)

**OPTIONAL**

**OPZ08573B**

Morsetto KT13 per Cavith  
Jaw KT13 for Cavith  
Spannbacke KT13 für Cavith  
Étau KT13 pour Cavith  
Mordaza KT13 para Cavith



**ARCADIA**

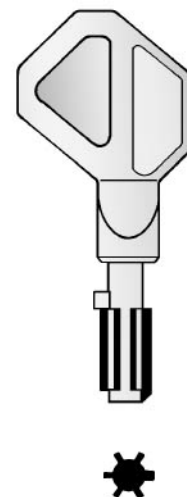

TO FIT: **CHIAVI A CROCE - CRUCIFORM KEYS**

STANDARD



+  
XBU2P  
XBU3P

+  
XYE1P



**NINJA TOTAL**



**CARAT/106**



**101/102  
103/104**



**105**



**EURO/ECO  
EASY/LUPO**



**NINJA  
NINJA DARK**



TO FIT : **CHIAVI PER CASELLARI POSTALI (USA) - MAIL BOX KEYS (USA)**

**OPTIONAL**

**OPZ05309B**

Set per chiavi casellari postali USA  
 Mail box key set USA  
 USA Postfachschlüsselsatz  
 Set pour clés casiers postaux USA  
 Set de llaves para casillas postales USA

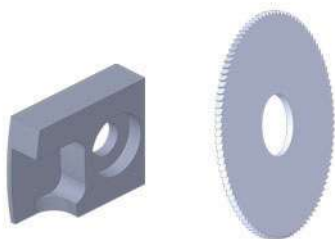

**CARAT/106**

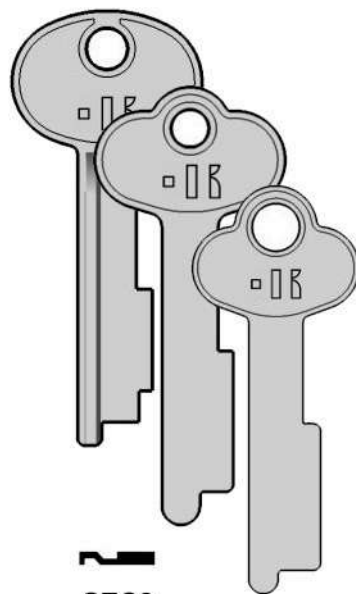

**STANDARD**



**206**

SEC2

YOR2

DIE3

TO FIT : **DAD-DECAYEUX (F)**

**OPTIONAL**

**OPZ08888B**

Morsetto KT7 per FTH/Dad-Decayeux  
 Jaw KT7 for FTH/Dad-Decayeux  
 Spannbacke KT7 für FTH/Dad-Decayeux  
 Étau KT7 pour FTH/Dad-Decayeux  
 Mordaza KT7 para FTH/Dad-Decayeux



**ARCADIA**



TO  
FIT: **FTH (F)**

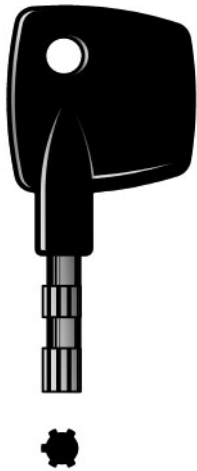

**ARCADIA**

**OPTIONAL**



**OPZ08888B**

*Morsetto KT7 per FTH/Dad-Decayeux  
Jaw KT7 for FTH/Dad-Decayeux  
Spannbacke KT7 für FTH/Dad-Decayeux  
Étau KT7 pour FTH/Dad-Decayeux  
Mordaza KT7 para FTH/Dad-Decayeux*

TO  
FIT: **JPM (F)**

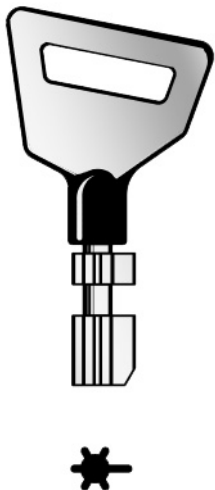

**ARCADIA**

**OPTIONAL**



**OPZ08885B**

*Morsetto KT6 per JPM  
Jaw KT6 for JPM  
Spannbacke KT6 für JPM  
Étau KT6 pour JPM  
Mordaza KT6 para JPM*

TO  
FIT :

LAPERCHE (F)

OPTIONAL



**OPZ08558B**

*Morsetto KT5 per Laperche*  
*Jaw KT5 for Laperche*  
*Spannbacke KT5 für Laperche*  
*Étau KT5 pour Laperche*  
*Mordaza KT5 para Laperche*



**ARCADIA**

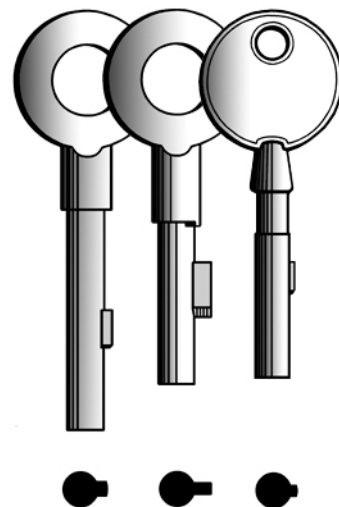

TO  
FIT :

POLLUX (F)

OPTIONAL



**OPZ08568B**

*Morsetto KT8 per Pollux*  
*Jaw KT8 for Pollux*  
*Spannbacke KT8 für Pollux*  
*Étau KT8 pour Pollux*  
*Mordaza KT8 para Pollux*



**ARCADIA**

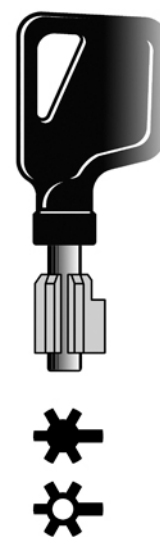

TO  
FIT: POLLUX (F)

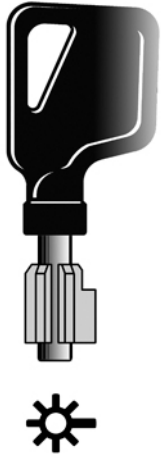

**ARCADIA**

**OPTIONAL**



**OPZ08579B**  
*Morsetto KT9 per Pollux*  
*Jaw KT9 for Pollux*  
*Spannbacke KT9 für Pollux*  
*Étau KT9 pour Pollux*  
*Mordaza KT9 para Pollux*

TO  
FIT: PROGRES FONTAINE (F) - CORNI (I)

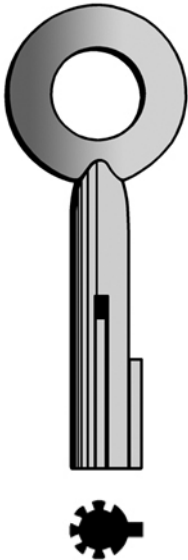

**ARCADIA**

**OPTIONAL**



**OPZ08575B**  
*Morsetto KT3 per Progres Fontaine / Corni*  
*Jaw KT3 for Progres Fontaine / Corni*  
*Spannbacke KT3 für Progres Fontaine / Corni*  
*Étau KT3 pour Progres Fontaine / Corni*  
*Mordaza KT3 para Progres Fontaine / Corni*

- \* 8 Posizioni
- \* 8 Positions
- \* 8 Positionen
- \* 8 Positions
- \* 8 Posiciones

TO  
FIT :

# PROGRES FONTAINE (F) - CORNI (I)

OPTIONAL



**OPZ08620B**

*Morsetto KT2 per Progres Fontaine/Corni*  
*Jaw KT2 for Progres Fontaine/Corni*  
*Spannbacke KT2 für Progres Fontaine/Corni*  
*Étau KT2 pour Progres Fontaine/Corni*  
*Mordaza KT2 para Progres Fontaine/Corni*



**ARCADIA**

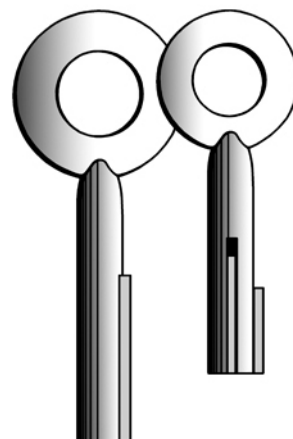

\* 6 Posizioni  
\* 6 Positions  
\* 6 Positionen  
\* 6 Positions  
\* 6 Posiciones

TO  
FIT :

# CHIAVI TUBOLARI - TUBULAR KEYS

OPTIONAL

**MT**

*Morsetti per chiavi tubolari*  
*Jaws for tubular keys*  
*Spannbacken für Steckschlüssel*  
*Étaux pour clés tubulaires*  
*Mordazas para llaves tubulares*

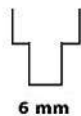

6 mm

**RIC01818B**  
*Fresino HC131*  
*Cutter HC131*  
*Fräser HC131*  
*Fraise HC131*  
*Fresa HC131*



**RIC01819B**  
*Tastatore C131*  
*Tracer Point C131*  
*Taster C131*  
*Palpeur C131*  
*Palpador C131*



**303/304/305**

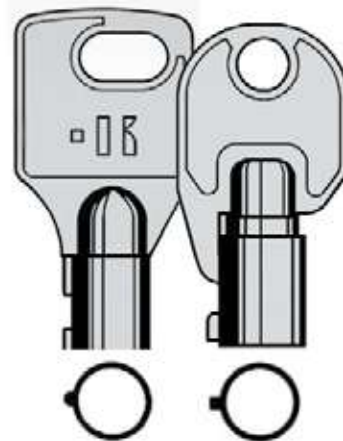

OPTIONAL

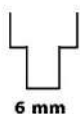

6 mm

**RIC01818B**  
*Fresino HC131*  
*Cutter HC131*  
*Fräser HC131*  
*Fraise HC131*  
*Fresa HC131*

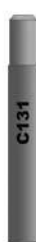

**RIC01819B**  
*Tastatore C131*  
*Tracer Point C131*  
*Taster C131*  
*Palpeur C131*  
*Palpador C131*



**T-REX  
T-REX ADVANCE**





TO FIT: **CHIAVI TUBOLARI - TUBULAR KEYS**

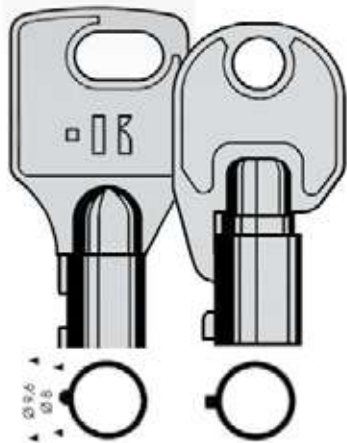

ME17T



ME18T



**ARCADIA**

OPTIONAL

**OPZ09216B**

Morsetto KT0 per Meroni e Chicago  
 Jaw KT0 for Meroni and Chicago  
 Spannbacke KT0 für Meroni und Chicago  
 Étau KT0 pour Meroni et Chicago  
 Mordaza KT0 para Meroni y Chicago



TO FIT: **CHIAVI TUBOLARI - TUBULAR KEYS**

- CHICAGO (USA)
- FORT (USA)
- KENSTAN (USA)
- L&F (GB)
- OGDEN (USA)
- RONIS (D) CH9T(9.60)
- MERONI (I) ME17T(9.60)
- ME18T(9.60)
- P.CORTELLAZZI (I) PC2T(9.60)



**NINJA TOTAL**



**NINJA VORTEX**

OPTIONAL



2.5 mm



**RIC05048B**  
 Fresino V003  
 Cutter V003  
 Fräser V003  
 Fraise V003  
 Fresa V003

**OPZ10677B**

Morsetto C34  
 Jaw C34  
 Spannbacke C34  
 Étau C34  
 Mordaza C34

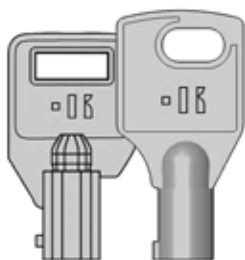

PC1T



ME17T  
 ME18T

BILMA (E)  
 AGA(E)



TO  
FIT :

# VIGIE PICARD (F)

**OPTIONAL**

**OPZ08582B**

*Morsetto KT4 per Vigie Picard  
Jaw KT4 for Vigie Picard  
Spannbacke KT4 für Vigie Picard  
Étau KT4 pour Vigie Picard  
Mordaza KT4 para Vigie Picard*



**ARCADIA**

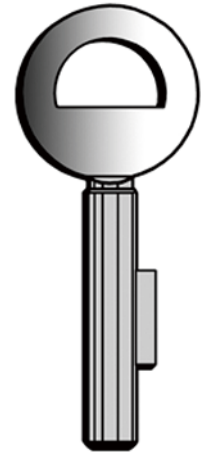

TO  
FIT :

# CHIAVI A Y - Y KEYS

**OPTIONAL**

**MY**

*Morsetti per chiavi a Y  
Jaws for Y keys  
Spannbacken für Y - Schlüssel  
Étaux pour clés à Y  
Mordazas para llaves Y*



**CARAT/106**



**101/102  
103/104**



**EURO/ECO  
EASY/LUPO**

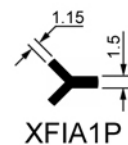
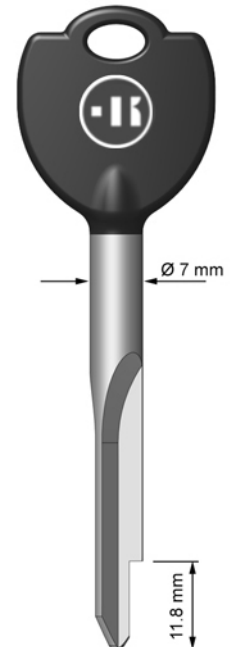

**ACCESSORI GENERICI OPZIONALI**

---

**OPTIONAL GENERIC ACCESSORIES**

---

**OPTIONAL ALLGEMEINE ZUBEHÖRE**

---

**ACCESSOIRES VARIÉS OPTIONAUX**

---

**ACCESORIOS GENÉRICOS OPCIONALES**

---



**BIANCHI 1770 GROUP**

*Innovators by design | Since 1770*



**OPZ02600B**

Morsetti basculanti 304  
 Tilting Jaws 304  
 Schwenkbare-Spannbacken 304  
 Étaux basculantes 304  
 Mordazas basculantes 304

**303****OPZ05017B**

Kit completo UK Aspirazione per 994 Laser  
 Complete UK Vacuum Kit for 994 Laser  
 Komplette UK Saugen Kit AK29 für 994 Laser  
 Kit complète UK de Aspiration pour 994 Laser  
 Kit completo UK de Aspiración para 994 Laser

**OPZ05013B**

Kit completo USA-Japan Aspirazione per 994 Laser  
 Complete USA-Japan Vacuum Kit for 994 Laser  
 Komplette USA-Japan Saugen Kit AK29 für 994 Laser  
 Kit complète USA-Japan de Aspiration pour 994 Laser  
 Kit completo USA-Japan de Aspiración para 994 Laser

**OPZ05015B**

Kit completo EU Aspirazione per 994 Laser  
 Complete EU Vacuum Kit for 994 Laser  
 Komplette EU Saugen Kit AK29 für 994 Laser  
 Kit complète EU de Aspiration pour 994 Laser  
 Kit completo EU de Aspiración para 994 Laser

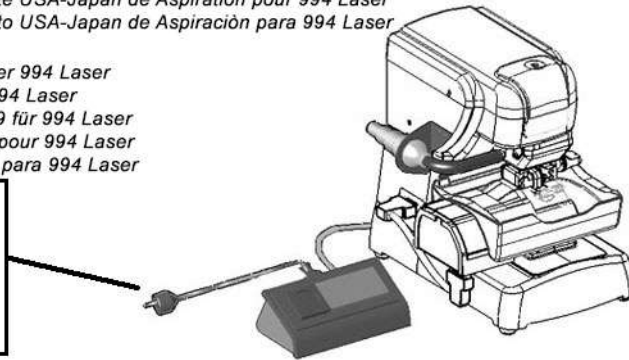
**994 LASER****OPZ04219B**

Kit Aspirazione per 994 Laser  
 Vacuum Kit for 994 Laser  
 Saugen Kit AK29 für 994 Laser  
 Kit de Aspiacion pour 994 Laser  
 Kit de Aspiración para 994 Laser

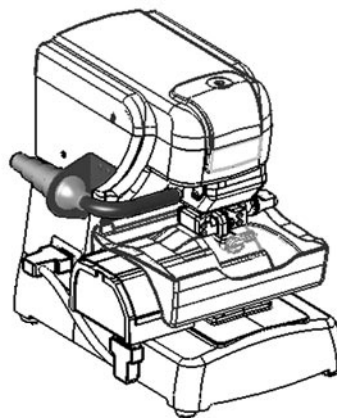
**994 LASER****OPZ08462B**

Morsetto F per chiavi piatte  
 Jaw F for edge-cut keys  
 Spannbacke F für Flachschlüssel  
 Étau F pour clés plates  
 Mordaza F para llaves planas

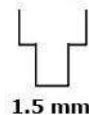
**RIC08409B**

Fresino per morsetto F  
 Cutter for Jaw F  
 Fräser für Spannbacke F  
 Fraise pour Étau F  
 Fresa para Mordaza F

**RIC08410B**

Tastatore TL002  
 Tracer Point TL002  
 Taster TL002  
 Palpeur TL002  
 Palpador TL002

**994 LASER WITH OLD CONSOLE**



### 994 LASER

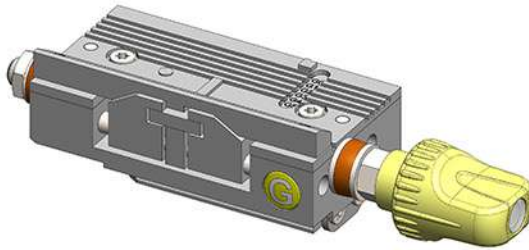

**OPZ09486B**  
 Morsetto G per chiavi piatte  
 Jaw G for edge-cut keys  
 Spannbacke G für Flachschlüssel  
 Étau G pour clés plates  
 Mordaza G para llaves planas

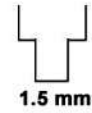

1.5 mm

**RIC09617B**  
 Fresino CL005  
 Cutter CL005  
 Fräser CL005  
 Fraise CL005  
 Fresa CL005



**RIC09483B**  
 Tastatore TL003  
 Tracer Point TL003  
 Taster TL003  
 Palpeur TL003  
 Palpador TL003



### NINJA VORTEX

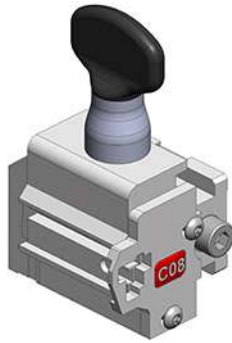

**OPZ06039B**  
 Morsetto C08 per chiavi piatte  
 Jaw C08 for edge-cut keys  
 Spannbacke C08 für Flachschlüssel  
 Étau C08 pour clés plates  
 Mordaza C08 para llaves planas



**OPZ06377B**  
 Tastatore T003  
 Tracer T003  
 Taster T003  
 Palpeur T003  
 Palpador T003



### VERSA



### DEZMO

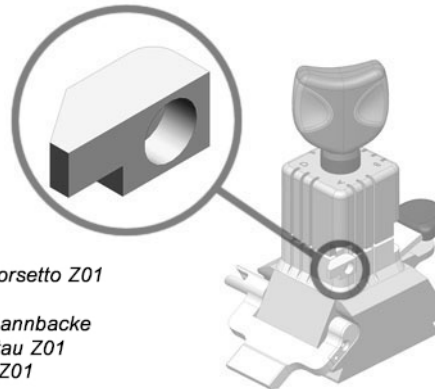

**OPZ08727B**  
 Dispositivo antiribaltamento per morsetto Z01  
 Anti-rollover tool for Z01 jaw  
 Anti-Überroll Werkzeug für Z01 Spannbacke  
 Dispositif anti-reversament pour étau Z01  
 Dispositivo antigiro para mordaza Z01



**OPZ09874B**

*Fermo Punta Magnetico per morsetti Ninja*  
*Magnetic tip-stop for Ninja jaw*  
*Magnetischer Tippanschlag für Ninja Spannbacke*  
*Cale de butée magnétique pour étau Ninja*  
*Tope magnético para mordaza Ninja*

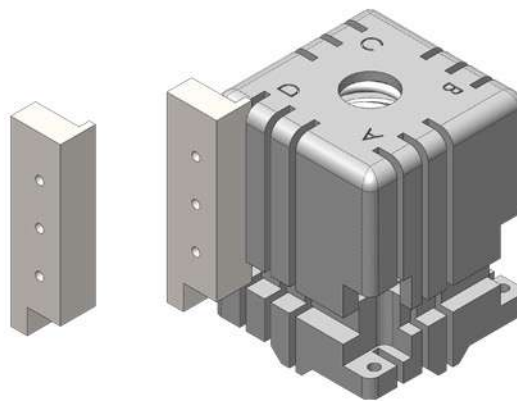

**NINJA LASER**



**NINJA TOTAL**



**NINJA  
NINJA DARK**

**OPZ10596B**

*Dispositivo antiribaltamento per morsetti Ninja*  
*Anti-rollover tool for Ninja jaw*  
*Anti-Überroll Werkzeug für Ninja Spannbacke*  
*Dispositif anti-reversament pour étau Ninja*  
*Acessorio antigiro para mordaza Ninja*

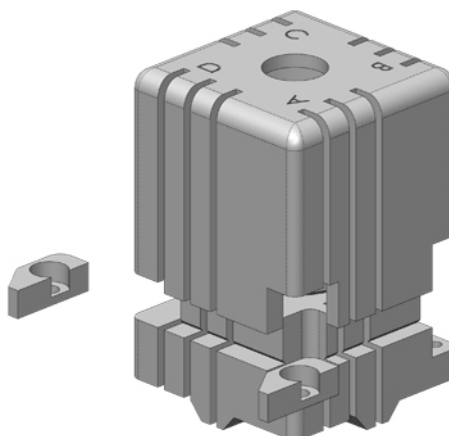

**NINJA LASER**



**NINJA TOTAL**

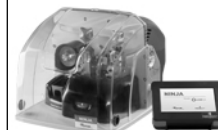

**NINJA  
NINJA DARK**

**GUIDA VELOCE AI SISTEMI CHIAVI LASER**

---

**QUICK GUIDE TO LASER KEY SYSTEMS**

---

**KURZANLEITUNG FÜR LASER-SCHLÜSSEL SYSTEME**

---

**GUIDE RAPIDE DES SYSTEMES DE CLÉS LASER**

---

**GUÍA RÁPIDA A LOS SISTEMAS LLAVES LÁSER**

---

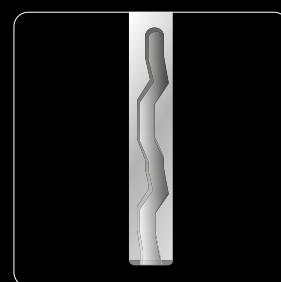

# QUICK GUIDE TO LASER KEY SYSTEMS

## 994 LASER | NINJA LASER | NINJA TOTAL CAR KEYS

MAKE	KEY SYSTEM	SERIES	KL REFERENCE	994 LASER			NINJA LASER			NINJA TOTAL		
				Jaw	Adaptor	Cutter	Jaw	Adaptor	Cutter	Jaw	Adaptor	Cutter
ABARTH	2ITL 8	(.....) ABCD DE00001-DE11210	FT22U	C		WC011A	AC		WC011A	A03		V003
ACURA	4ET 6+6	H001-N718 K001-N718	HD1U	A		WC011A	AC		WC011A	C30		V003
	4IT 5+5	12345	ORIGINAL	B		WC011A	B		WC011A	A02		V003
ALFA ROMEO	2ITL 8	(.....) ABCD DE00001-DE11210	FT22U	C		WC011A	AC		WC011A	A03		V003
ASTON MARTIN	2ETR 10	01-3022 H1-H3000 WH1-WH3000	VX4P	A		WC011A	AC		WC011A	C30		V003
AUDI	2ITL 8	1-6000 EXT 6001-8100 EXT HAA0001-8110 EXT HAA6001-8110 NAA0001-8110 EXT NAA6001-8110	AD66U	C		WC011A	AC		WC011A	A03		V003
		0001-6000 6001-8100 1ATS1-1ATS17850 HAA0001-2000 HAA0001-6000 HAA0001-8110 NAA0001-2000 NAA0001-8110	AD66U	C		WC011A	AC		WC011A	A03		V003
BMW	2ITL 8	HF000001-HF004001 Z0001-Z1000	ORIGINAL	C		WC011A	AC		WC011A	A03		V003
	2ITR 8	0001-8100	BM2U	C		WC011A	AC		WC011A	A03		V003
	4ET 6+6	BH010001-BH241450	HU58P	B		WC011A	B		WC011A	A02		V003
BUICK	2ITR 8	Z0001-Z2000 Z0001-Z6000 Z0001-Z6314 Z2001-Z4000	VX5U	C		WC011A	AC		WC011A	A03		V003
CADILLAC	2ITR 8	Z0001-Z2000 Z0001-Z6000 Z2001-Z4000 Z4001-Z6314	VX5U	C		WC011A	AC		WC011A	A03		V003
	2ITR 10	V0001-V6000	VX5U	A C		WC011A WC011A	AC		WC011A	A03		V003
CHEVROLET	2ITR 8	0001-3679 Z0001-Z6000	ORIGINAL	C		WC011A	AC		WC011A	A03		V003
		Z0001-Z2000 Z2001-Z4000 Z4001-Z6314	VX5U	C		WC011A	AC		WC011A	A03		V003
	2ITR 10	V0001-V5718 V0001-V6000	ORIGINAL VX5U	C C		WC011A WC011A	AC AC		WC011A WC011A	A03 A03		V003 V003
CHRYSLER	2ETL 10 ROUND	1002001-1003200	MB41P	D		WC011A	D		WC011A	A04		V003
	2ETL FLAT 10	0001-0355 3501-6700 1003501-1006700	MB57P	D		WC011A	D		WC011A	A04		V003
CITROËN	2ITR 7 LARGE	1-2000 HCA0001-HCA2000 HO0HCA1-HO0HCA2000	PG83U	C		WC011A	AC		WC011A	A03		V003
DODGE	2ETL FLAT 10	3501-6700	MB57P	D		WC011A	D		WC011A	A04		V003
EUNOS	4IT 8+8	20001-21200	ORIGINAL	A		WC011A	AC		WC011A	C30		V003
FIAT	2ITL 8	(.....) ABCD DE00001-DE11210	FT22U	C		WC011A	AC		WC011A	A03		V003
	2ITR 7 LARGE	1-2000 HCA0001-HCA2000	PG83U	C		WC011A	AC		WC011A	A03		V003
FORD (AUSTRALIA)	2ETR 10	0001-4000	FD40U	A		WC011A	AC		WC011A	C30		V003
FORD (EUROPE)	2ETR 10	0001-4000	FD40U	A		WC011A	AC		WC011A	C30		V003

# QUICK GUIDE TO LASER KEY SYSTEMS

## 994 LASER | NINJA LASER | NINJA TOTAL CAR KEYS

MAKE	KEY SYSTEM	SERIES	KL REFERENCE	994 LASER			NINJA LASER			NINJA TOTAL		
				Jaw	Adaptor	Cutter	Jaw	Adaptor	Cutter	Jaw	Adaptor	Cutter
FORD (EUROPE)	2ITL 8	DE00001-DE11210	FT22U	C		WC011A	AC		WC011A	A03		V003
		HAA0001-8110	AD66U	C		WC011A	AC		WC011A	A03		V003
FORD (USA)	2ETR 7	11501-13000	FD40U	A		WC011A	AC		WC011A	C30		V003
	2ETR 10	0001-4000 10001-11500 10001-14514 14515-15014	FD40U	A		WC011A	AC		WC011A	C30		V003
GENESIS	4IT 4+3	X0001-X2245	TR49U	A		WC011A	AC		WC011A	C30		V003
	4IT 4+3 SLIM	I0001-I2608	ORIGINAL	A	AD03	WC011A	AC	AD03	WC011A	C30	AD03	V003
GMC	2ITR 8	Z0001-Z6000	VX5U	C		WC011A	AC		WC011A	A03		V003
	2ITR 10	V0001-V5718 V0001-V6000	VX5U	C		WC011A	AC		WC011A	A03		V003
HOLDEN	2ETR 10	H1-H3000 M1-M3000 WH1-WH3000	VX4U	A		WC011A	AC		WC011A	C30		V003
		WY1-WY3000 Y1-Y3000	VX3U	A		WC011A	AC		WC011A	C30		V003
	2ITR 8	Z0001-Z6314	VX5U	C		WC011A	AC		WC011A	A03		V003
HONDA	4ET 6+6	0H001-0N718 0K001-0N718 (A/Z)H001-N718 (A/Z)K001-N718 H001-N718 K001-N718	HD1U	A		WC011A	AC		WC011A	C30		V003
	4IT 5+5	12345	ORIGINAL	B		WC011A	B		WC011A	A02		V003
HYUNDAI	2ITL 8	1001-3500 T1001-T3500 X1001-3500	HY21U	A		WC011A	AC		WC011A	C30		V003
		5001-6616	HY20U	C		WC011A	AC		WC011A	A03		V003
		B0001-B3000	ORIGINAL	A		WC011A	AC		WC011A	C30		V003
	2ITR 8	C1001-C3500	ORIGINAL	A		WC011A	AC		WC011A	A03		V003
	4IT 6+6	G0001-G2500 HK1-HK2500 J0001-J2500 K0001-K2500 T1-T2500	TR49U	A		WC011A	AC		WC011A	C30		V003
	4IT SLIM 4+3	B0001-B2608 I0001-I2608 X0001-X2245	ORIGINAL	A	AD03	WC011A	AC	AD03	WC011A	C30	AD06	V003
INFINITI	4ET 5+5	0001-2000 2001-6000	ORIGINAL	A	AD02	WC011A	AC	AD02	WC011A	C30	AV01	V003
JEEP	2ITL 8	DE00001-DE11210	FT22U	C		WC011A	AC		WC011A	A03		V003
KIA	2ETL 7	0001-2300	ORIGINAL	A		WC011A	AC		WC011A	C30		V003
	2ITL 8	B0001-B3000 D0001-D3000	ORIGINAL	A		WC011A	AC		WC011A	C30		V003
		C0001-C2900 KC001-KC2500 TB1001-3500	ORIGINAL	A		WC011A	AC		WC011A	C30		V003
	2ITR 8	UM1001-UM3500	ORIGINAL	A		WC011A	AC		WC011A	A03		V003
	4IT 4+3	KU0001-KU2608 U0001-U2500	TR49U	A		WC011A	AC		WC011A	C30		V003
	4IT 6+6	E1-E2500 G0001-G2500 K0001-K2500 KE0001-KE2500 KG1-KG2500 T1-T2500 V0001-V2500	TR49U	A		WC011A	AC		WC011A	C30		V003
4IT 8+8	L0001-L1037	KI4		A		WC011A	AC		WC011A	C30		V003
	L1-L1037	TR49U		A		WC011A	AC		WC011A	C30		V003

# QUICK GUIDE TO LASER KEY SYSTEMS

## 994 LASER | NINJA LASER | NINJA TOTAL CAR KEYS

MAKE	KEY SYSTEM	SERIES	KL REFERENCE	994 LASER			NINJA LASER			NINJA TOTAL		
				Jaw	Adaptor	Cutter	Jaw	Adaptor	Cutter	Jaw	Adaptor	Cutter
KIA	4IT SLIM 4+3	I0001-I2608	ORIGINAL	A	AD03	WC011A	AC	AD03	WC011A	C30	AD06	V003
LANCIA	2ITL 8	(.....) ABCD DE00001-DE11210	FT22U	C		WC011A	AC		WC011A	A03		V003
LAND ROVER	2ETR 10	0001-4000	FD40U	A		WC011A	AC		WC011A	C30		V003
	2ITR 8	00001-81000	BM22P	C		WC011A	AC		WC011A	A03		V003
	4ET 5+5	1-6000	ORIGINAL	B		WC011A	B		WC011A	A02		V003
LEXUS	4IT 4+4	80000-89999	ORIGINAL	A	AD03	WC011A	AC	AD03	WC011A	C30	AD06	V003
	4IT 5+5	40000-49999	TR48U	A		WC011A	AC		WC011A	C30		V003
	4IT 8+8	0001-5000 00001-05000	TR50P	A		WC011A	AC		WC011A	C30		V003
LINCOLN	2ETR 10	10001-11500	FD40U	A		WC011A	AC		WC011A	C30		V003
MAHINDRA	2ETR 10	12345 00001-03001	FD40U	A		WC011A	AC		WC011A	C30		V003
	2ITL 8	5001-6616	ORIGINAL	C		WC011A	AC		WC011A	A03		V003
MAZDA	4IT 8+8	20001-21200	ORIGINAL	A		WC011A	AC		WC011A	C30		V003
MERCEDES	2ET SHORT 10	(.....)12345	MB54P	D	AD05	WC011A	D	AD05	WC011A	A04		V003
	2ET-R ROUND 10	HA2001-HA3200 HA2501-HA3500 NA2001-NA3200 NA2501-NA3500	MB54P	D		WC011A	D		WC011A	A04		V003
	2ETL FLAT 10	0001-0355 3501-6700 1003501-1006700 210103210101-...200	MB57P	D		WC011A	D		WC011A	A04		V003
	2ETL LONG 13	HA10001-HA30057 NA10001-NA30057	MB58P	D		WC011A	D		WC011A	A04		V003
	4ET 8+8	2002001-2003500 700001-703000 HS2001-HS3500 NS2001-NS3500	MB53P	A		WC011A	AC		WC011A	C30		V003
MITSUBISHI	2ETR 8	00001-04000 DH0001-DH4000 DH6001-DH8000	VL15P	B		WC011A	B		WC011A	A02		V003
	4IT 8+8	30001-31200	TR49U	A		WC011A	AC		WC011A	C30		V003
NISSAN	4ET 5+5	0001-2000 2001-6000	ORIGINAL	A	AD02	WC011A	AC	AD02	WC011A	C30	AV01	V003
OPEL	2ETR 10	1-3022 HI-H3000 M1-M3000 WY1-WY3000 Y1-Y3000	VX3U	A		WC011A	AC		WC011A	C30		V003
	2ITR 8	1-3679 Z0001-Z2000 Z0001-Z6314 Z2001-Z4000 Z4001-Z6314	VX5U	C		WC011A	AC		WC011A	A03		V003
PEUGEOT	2ITL 6	ABCDEF	PG33U	C		WC011A	AC		WC011A	A03		V003
	2ITL 8	(.....) ABCD DE00001-DE11210	FT22U	C		WC011A	AC		WC011A	A03		V003
	2ITR 7 LARGE	1-2000 HCA0001-HCA2000 HOHCA1-HOHCA2000	PG83U	C		WC011A	AC		WC011A	A03		V003
	4ET 5+5	0123456789ABCDEF	PG31U	B		WC011A	B		WC011A	A02		V003
	4IT-T THIN 6	ABCDEF (0/Z 0/Z 0/Z 0/Z...) ABCDEF	PG33U	C		WC011A	AC		WC011A	A03		V003
PORSCHE	2ITL 8	01-06000 1-6000 1-6000 EXT 6001-8100 6001-8100 EXT HAA0001-8110	AD66U	C		WC011A	AC		WC011A	A03		V003



# QUICK GUIDE TO LASER KEY SYSTEMS

## 994 LASER | NINJA LASER | NINJA TOTAL CAR KEYS

MAKE	KEY SYSTEM	SERIES	KL REFERENCE	994 LASER			NINJA LASER			NINJA TOTAL		
				Jaw	Adaptor	Cutter	Jaw	Adaptor	Cutter	Jaw	Adaptor	Cutter
RAM	2ITL 8	DE00001-DE11210	FT22U	C		WC011A	AC		WC011A	A03		V003
RANGE ROVER	2ETR 10	0001-4000	FD40AP	A		WC011A	AC		WC011A	C30		V003
	4ET 5+5	1-6000	ORIGINAL	B		WC011A	B		WC011A	A02		V003
RENAULT	2ITL 7	000001-992196	HY21U	A		WC011A	AC		WC011A	C30		V003
	2ITR 6	UC0001-UC1200	PG33U	A		WC011A	AC		WC011A	A03		V003
SAAB	2ETR 10	2S1-2S2675 BC1-BC2865	ORIGINAL	A		WC011A	AC		WC011A	C30		V003
	2ITL 7	DA1-DA2892	ORIGINAL	C		WC011A	AC		WC011A	A03		V003
	2ITL 8	DB1-DB4500	ORIGINAL	C		WC011A	AC		WC011A	A03		V003
	2ITR 8	Z0001-Z6314	VX5U	C		WC011A	AC		WC011A	A03		V003
SATURN	2ITR 8	Z0001-Z6000	VX5U	C		WC011A	AC		WC011A	A03		V003
SEAT	2ITL 8	HAA0001-8110	AD66U	C		WC011A	AC		WC011A	A03		V003
SMART	2ETR 8	DH0001-DH4000 DH6001-DH8000	ORIGINAL	B		WC011A	B		WC011A	A02		V003
	2ITL 6	1234Q5678H	PG33U	A		WC011A	AC		WC011A	A03		V003
SSANGYONG	4IT 6+6	KW1-KW2500	TR50P	A		WC011A	AC		WC011A	C30		V003
SUBARU	4ET 5+5	T0001-T3000	SUB1U	A		WC011A	AC		WC011A	C30		V003
TOYOTA	2ETR 10	H1-H3000 M1-M3000 WH1-WH3000	VX4P	A		WC011A	AC		WC011A	C30		V003
	2ITL 6	12897-A9999 B1085-B9547	PG33U	A		WC011A	AC		WC011A	A03		V003
	2ITL 8	025A1-WV6AG	ORIGINAL	A		WC011A	AC		WC011A	C30		V003
	4IT 4+4	80000-89999	ORIGINAL	A	AD03	WC011A	AC	AD03	WC011A	C30	AD06	V003
	4IT 5+5	40000-49999	TR48U	A		WC011A	AC		WC011A	C30		V003
	4IT 8+8	0001-5000 00001-05000	TR50P	A		WC011A	AC		WC011A	C30		V003
VOLKSWAGEN	2ITL 8	(.....)12345	HU163SU	C		CL005	AC		CL005	A03		V012
		HAA0001-6000 HAA0001-8110 NAA0001-8110	V66U	C		WC011A	AC		WC011A	A03		V003
	2ITL 9+3+3	(.....)12345	HU162U	V		CL005	V		CL005			
VOLVO	2ETR 8	A001-F099	ORIGINAL	A		WC011A	AC		WC011A	C30		V003
		DH0001-DH4000 DH6001-DH8000	VL15P	B		WC011A	B		WC011A	A02		V003
		DN6001-DN8000	VL16P	B		WC011A	B		WC011A	A02		V003
	2ETR 10	04001-09001 4001-9001	VL22P	A		WC011A	AC		WC011A	C30		V003
	4ET 4+4	0AAAA-9XXXX 1V00001-5V12295 AOSAYK-YKGYGC	VL17P	A		WC011A	AC		WC011A	C30		V003

## 994 LASER | NINJA LASER | NINJA TOTAL MOTORCYCLE KEYS

MAKE	KEY SYSTEM	SERIES	KL REFERENCE	994 LASER			NINJA LASER			NINJA TOTAL		
				Jaw	Adaptor	Cutter	Jaw	Adaptor	Cutter	Jaw	Adaptor	Cutter
APRILIA	4IT 5+4	Z2001-Z9416	ZAD30U	A	AV08	WC011A	AC	AV08	WC011A	C30	AV08	V016
BAJAJ	2ETR 8	00001-03001	FD40U	A		WC011A	AC		WC011A	C30		V003
DUCATI	4IT 5+4	Z2001-Z9416	ZAD30U	A	AV08	WC011A	AC	AV08	WC011A	C30	AV08	V016
GILERA	2ITL 8	DE1-DE11210	FT22U	C		WC011A	AC		WC011A	A03		V003
KTM	2ETR 8	00001-03001	FD40U	A		WC011A	AC		WC011A	C30		V003
MOTO GUZZI	4IT 5+4	Z2001-Z9416	ZAD30U	A	AV08	WC011A	AC	AV08	WC011A	C30	AV08	V016

# QUICK GUIDE TO LASER KEY SYSTEMS

## NINJA VORTEX | VERSA CAR KEYS

MAKE	KEY SYSTEM	SERIES	KL REFERENCE	NINJA VORTEX			VERSA		
				Jaw	Adaptor	Cutter	Jaw	Adaptor	Cutter
ABARTH	2ITL 8	(.....) ABCD DE00001-DE11210	FT22U	A03		V003	A03		V003
ACURA	4ET 6+6	H001-N718 K001-N718	HD1U	A01		V003	A01		V003
	4IT 5+5	12345	ORIGINAL	A02		V003	A02		V003
ALFA ROMEO	2ITL 8	(.....) ABCD DE00001-DE11210	FT22U	A03		V003	A03		V003
ASTON MARTIN	2ETR 10	01-3022 H1-H3000 WH1-WH3000	VX4P	A01		V003	A01		V003
AUDI	2ITL 8	1-6000 EXT 6001-8100 EXT HAA0001-8110 EXT HAA6001-8110 NAA0001-8110 EXT NAA6001-8110	AD66U	A03		V003	A03		V003
		6001-8100 1ATS1-1ATS17850 0001-6000 HAA0001-2000 HAA0001-6000 HAA0001-8110 NAA0001-2000 NAA0001-8110	AD66U	A03		V003	A03		V003
BMW	2ITL 8	HF000001-HF004001 Z0001-Z1000	ORIGINAL	A03		V003	A03		V003
	2ITR 8	0001-8100	BM2U	A03		V003	A03		V003
	4ET 6+6	BH010001-BH241450	HU58P	A02		V003	A02		V003
BUICK	2ITR 8	Z0001-Z2000 Z0001-Z6000 Z0001-Z6314 Z2001-Z4000	VX5U	A03		V003	A03		V003
CADILLAC	2ITR 8	Z0001-Z2000 Z0001-Z6000 Z2001-Z4000 Z4001-Z6314	VX5U	A03		V003	A03		V003
	2ITR 10	V0001-V6000	VX5U	A03		V003	A03		V003
CHEVROLET	2ITR 8	0001-3679 Z0001-Z6000	ORIGINAL	A03		V003	A03		V003
		Z0001-Z2000 Z2001-Z4000 Z4001-Z6314	VX5U	A03		V003	A03		V003
	2ITR 10	V0001-V5718	ORIGINAL	A03		V003	A03		V003
		V0001-V6000	VX5U	A03		V003	A03		V003
CHRYSLER	2ETL 10 ROUND	1002001-1003200	MB41P	A04		V003	A04		V003
	2ETL FLAT 10	0001-0355 3501-6700 1003501-1006700	MB57P	A04		V003	A04		V003
CITROËN	2ITR 7 LARGE	1-2000 HCA0001-HCA2000 HOOHCA1-HOOHCA2000	PG83U	A03		V003	A03		V003
DODGE	2ETL FLAT 10	3501-6700	MB57P	A04		V003	A04		V003
EUNOS	4IT 8+8	20001-21200	ORIGINAL	A01		V003	A01		V003
FIAT	2ITL 8	(.....) ABCD DE00001-DE11210	FT22U	A03		V003	A03		V003
	2ITR 7 LARGE	1-2000 HCA0001-HCA2000	PG83U	A03		V003	A03		V003
FORD (AUSTRALIA)	2ETR 10	0001-4000	FD40U	A01		V003	A01		V003
FORD (EUROPE)	2ETR 10	0001-4000	FD40U	A01		V003	A01		V003

# QUICK GUIDE TO LASER KEY SYSTEMS

## NINJA VORTEX | VERSA CAR KEYS

MAKE	KEY SYSTEM	SERIES	KL REFERENCE	NINJA VORTEX			VERSA		
				Jaw	Adaptor	Cutter	Jaw	Adaptor	Cutter
FORD (EUROPE)	2ITL 8	DE00001-DE11210	FT22U	A03		V003	A03		V003
		HAA0001-8110	AD66U	A03		V003	A03		V003
FORD (USA)	2ETR 7	11501-13000	FD40U	A01		V003	A01		V003
	2ETR 10	0001-4000 10001-11500 10001-14514 14515-15014	FD40U	A01		V003	A01		V003
GENESIS	4IT 4+3	X0001-X2245	TR49U	A01		V003	A01		V003
	4IT 4+3 SLIM	I0001-I2608	ORIGINAL	A01	AD06	V003	A01	AD06	V003
GMC	2ITR 8	Z0001-Z6000	VX5U	A03		V003	A03		V003
	2ITR 10	V0001-V5718 V0001-V6000	VX5U	A03		V003	A03		V003
HOLDEN	2ETR 10	H1-H3000 M1-M3000 WH1-WH3000	VX4U	A01		V003	A01		V003
	2ETR 10	WY1-WY3000 Y1-Y3000	VX3U	A01		V003	A01		V003
	2ITR 8	Z0001-Z6314	VX5U	A03		V003	A03		V003
HONDA	4ET 6+6	0H001-0N718 0K001-0N718 (A/Z)H001-N718 (A/Z)K001-N718 H001-N718 K001-N718	HD1U	A01		V003	A01		V003
	4IT 5+5	12345	ORIGINAL	A02		V003	A02		V003
HYUNDAI	2ITL 8	1001-3500 T1001-T3500 X1001-3500	HY21U	A01		V003	A01		V003
		5001-6616	HY20U	A03		V003	A03		V003
		B0001-B3000	ORIGINAL	A01		V003	A01		V003
	2ITR 8	C1001-C3500	ORIGINAL	A03		V003	A03		V003
	4IT 6+6	G0001-G2500 HK1-HK2500 J0001-J2500 K0001-K2500 T1-T2500	TR49U	A01		V003	A01		V003
4IT SLIM 4+3	B0001-B2608 I0001-I2608 X0001-X2245	ORIGINAL	A01	AD06	V003	A01	AD06	V003	
INFINITI	4ET 5+5	0001-2000 2001-6000	ORIGINAL	A01	AV01	V003	A01	AV01	V003
JEEP	2ITL 8	DE00001-DE11210	FT22U	A03		V003	A03		V003
KIA	2ETL 7	0001-2300	ORIGINAL	A01		V003	A01		V003
	2ITL 8	B0001-B3000 D0001-D3000	ORIGINAL	A01		V003	A01		V003
		C0001-C2900 KC001-KC2500 TB1001-3500	ORIGINAL	A01		V003	A01		V003
	2ITR 8	UM1001-UM3500	ORIGINAL	A03		V003	A03		V003
	4IT 4+3	KU0001-KU2608 U0001-U2500	TR49U	A01		V003	A01		V003
	4IT 6+6	E1-E2500 G0001-G2500 K0001-K2500 KE0001-KE2500 KG1-KG2500 T1-T2500 V0001-V2500	TR49U	A01		V003	A01		V003
4IT 8+8	L0001-L1037	KI4	A01		V003	A01		V003	
	L1-L1037	TR49U	A01		V003	A01		V003	

# QUICK GUIDE TO LASER KEY SYSTEMS

## NINJA VORTEX | VERSA CAR KEYS

MAKE	KEY SYSTEM	SERIES	KL REFERENCE	NINJA VORTEX			VERSA		
				Jaw	Adaptor	Cutter	Jaw	Adaptor	Cutter
KIA	4IT SLIM 4+3	I0001-I2608	ORIGINAL	A01	AD06	V003	A01	AD06	V003
LANCIA	2ITL 8	(.....) ABCD DE00001-DE11210	FT22U	A03		V003	A03		V003
LAND ROVER	2ETR 10	0001-4000	FD40U	A01		V003	A01		V003
	2ITR 8	00001-81000	BM22P	A03		V003	A03		V003
	4ET 5+5	1-6000	ORIGINAL	A02		V003	A02		V003
LEXUS	4IT 4+4	80000-89999	ORIGINAL	A01	AD06	V003	A01	AD06	V003
	4IT 5+5	40000-49999	TR48U	A01		V003	A01		V003
	4IT 8+8	0001-5000 00001-05000	TR50P	A01		V003	A01		V003
LINCOLN	2ETR 10	10001-11500	FD40U	A01		V003	A01		V003
MAHINDRA	2ETR 10	12345 00001-03001	FD40U	A01		V003	A01		V003
	2ITL 8	5001-6616	ORIGINAL	A03		V003	A03		V003
MAZDA	4IT 8+8	20001-21200	ORIGINAL	A01		V003	A01		V003
MERCEDES	2ET SHORT 10	(.....)12345	MB54P	A04		V003	-		-
	2ET-R ROUND 10	HA2001-HA3200 HA2501-HA3500 NA2001-NA3200 NA2501-NA3500	MB54P	A04		V003	A04		V003
	2ETL FLAT 10	0001-0355 3501-6700 1003501-1006700 210103210101-...200	MB57P	A04		V003	A04		V003
	2ETL LONG 13	HA10001-HA30057 NA10001-NA30057	MB58P	A04		V003	A04		V003
	4ET 8+8	2002001-2003500 700001-703000 HS2001-HS3500 NS2001-NS3500	MB53P	A01		V003	A01		V003
MITSUBISHI	2ETR 8	00001-04000 DH0001-DH4000 DH6001-DH8000	VL15P	A02		V003	A02		V003
	4IT 8+8	30001-31200	TR49U	A01		V003	A01		V003
NISSAN	4ET 5+5	0001-2000 2001-6000	ORIGINAL	A01	AV01	V003	A01	AV01	V003
OPEL	2ETR 10	1-3022 HI-H3000 M1-M3000 WY1-WY3000 Y1-Y3000	VX3U	A01		V003	A01		V003
	2ITR 8	1-3679 Z0001-Z2000 Z0001-Z6314 Z2001-Z4000 Z4001-Z6314	VX5U	A03		V003	A03		V003
PEUGEOT	2ITL 6	ABCDEF	PG33U	A03		V003	A03		V003
	2ITL 8	(.....) ABCD DE00001-DE11210	FT22U	A03		V003	A03		V003
	2ITR 7 LARGE	1-2000 HCA0001-HCA2000 HOOHCA1-HOOHCA2000	PG83U	A03		V003	A03		V003
	4ET 5+5	0123456789ABCDEF	PG31U	A02		V003	A02		V003
	4IT-T THIN 6	ABCDEF (0/Z 0/Z 0/Z 0/Z...) ABCDEF	PG33U	A03		V003	A03		V003
PORSCHE	2ITL 8	01-06000 1-6000 1-6000 EXT 6001-8100 6001-8100 EXT HAA0001-8110	AD66U	A03		V003	A03		V003

# QUICK GUIDE TO LASER KEY SYSTEMS

## NINJA VORTEX | VERSA CAR KEYS

MAKE	KEY SYSTEM	SERIES	KL REFERENCE	NINJA VORTEX			VERSA		
				Jaw	Adaptor	Cutter	Jaw	Adaptor	Cutter
RAM	2ITL 8	DE00001-DE11210	FT22U	A03		V003	A03		V003
RANGE ROVER	2ETR 10	0001-4000	FD40AP	A01		V003	A01		V003
	4ET 5+5	1-6000	ORIGINAL	A02		V003	A02		V003
RENAULT	2ITL 7	000001-992196	HY21U	A01		V003	A01		V003
	2ITR 6	UC0001-UC1200	PG33U	A03		V003	A03		V003
SAAB	2ETR 10	2S1-2S2675 BC1-BC2865	ORIGINAL	A03		V003	A03		V003
	2ITL 7	DA1-DA2892	ORIGINAL	A03		V003	A03		V003
	2ITL 8	DB1-DB4500	ORIGINAL	A03		V003	A03		V003
	2ITR 8	Z0001-Z6314	VX5U	A03		V003	A03		V003
SATURN	2ITR 8	Z0001-Z6000	VX5U	A03		V003	A03		V003
SEAT	2ITL 8	HAA0001-8110	AD66U	A03		V003	A03		V003
SMART	2ETR 8	DH0001-DH4000 DH6001-DH8000	ORIGINAL	A02		V003	A02		V003
	2ITL 6	1234Q5678H	PG33U	A03		V003	A03		V003
SSANGYONG	4IT 6+6	KW1-KW2500	TR50P	A01		V003	A01		V003
SUBARU	4ET 5+5	T0001-T3000	SUB1U	A01		V003	A01		V003
TOYOTA	2ETR 10	H1-H3000 M1-M3000 WH1-WH3000	VX4P	A03		V003	A03		V003
	2ITL 6	12897-A9999 B1085-B9547	PG33U	A03		V003	A03		V003
	2ITL 8	025A1-WV6AG	ORIGINAL	A01		V003	A01		V003
	4IT 4+4	80000-89999	ORIGINAL	A01	AD06	V003	A01	AD06	V003
	4IT 5+5	40000-49999	TR48U	A01		V003	A01		V003
	4IT 8+8	0001-5000 00001-05000	TR50P	A01		V003	A01		V003
VOLKSWAGEN	2ITL 8	(.....)12345	HU163SU	A03		V012	A03		V012
		HAA0001-6000 HAA0001-8110 NAA0001-8110	V66U	A03		V003	A03		V003
	2ITL 9+3+3	(.....)12345	HU162U						
VOLVO	2ETR 8	A001-F099	ORIGINAL	A01		V003	A01		V003
		DH0001-DH4000 DH6001-DH8000	VL15P	A02		V003	A02		V003
		DN6001-DN8000	VL16P	A02		V003	A02		V003
	2ETR 10	04001-09001 4001-9001	VL22P	A01		V003	A01		V003
	4ET 4+4	0AAAA-9XXXX 1V00001-5V12295 AOSAYK-YKGYGC	VL17P	A01		V003	A01		V003

## NINJA VORTEX | VERSA MOTORCYCLE KEYS

MAKE	KEY SYSTEM	SERIES	KL REFERENCE	NINJA VORTEX			VERSA		
				Jaw	Adaptor	Cutter	Jaw	Adaptor	Cutter
APRILIA	4IT 5+4	Z2001-Z9416	ZAD30U	A01	AV08	V016	A01	AV08	V016
BAJAJ	2ETR 8	00001-03001	FD40U	A01		V003	A01		V003
DUCATI	4IT 5+4	Z2001-Z9416	ZAD30U	A01	AV08	V016	A01	AV08	V016
GILERA	2ITL 8	DE1-DE11210	FT22U	A03		V003	A03		V003
KTM	2ETR 8	00001-03001	FD40U	A01		V003	A01		V003
MOTO GUZZI	4IT 5+4	Z2001-Z9416	ZAD30U	A01	AV08	V016	A01	AV08	V016



# QUICK GUIDE TO LASER KEY SYSTEMS

303 / 304 / 305 / PUNTO | T-REX / T-REX ADVANCE  
CAR KEYS

MAKE	KEY SYSTEM	KL REFERENCE	303 / 304 / 305 / PUNTO		T-REX / T-REX ADVANCE	
			Adaptor	Cutter	Adaptor	Cutter
ABARTH	2ITL 8	FT22U		HC011		HC011
ACURA	4ET 6+6	HD1U		HC011		HC011
	4IT 5+5	ORIGINAL		HC011		HC011
ALFA ROMEO	2ITL 8	FT22U		HC011		HC011
ASTON MARTIN	2ETR 10	VX4P	MOMAX	HC011	MOMAX	HC011
AUDI	2ITL 8	AD66U	MA	HC011 or HC030		HC011 or HC030
BMW	2ITL 8	ORIGINAL		HC011		HC011
	2ITR 8	BM2U		HC030		HC030
	4ET 6+6	HU58P		HC011		HC011
BUICK	2ITR 8	VX5U		HC011		HC011
CADILLAC	2ITR 8	VX5U		HC011		HC011
	2ITR 10	VX5U		HC011		HC011
CHEVROLET	2ITR 8	ORIGINAL		HC011		HC011
		VX5U		HC011		HC011
	2ITR 10	VX5U		HC011		HC011
		ORIGINAL		HC011		HC011
CHRYSLER	2ETL 10 ROUND	MB41P		HC011		HC011
	2ETL FLAT 10	MB57P	MM	HC011	MM	HC011
CITROËN	2ITR 7 LARGE	PG83U		HC030		HC030
DODGE	2ETL FLAT 10	MB57P	MM	HC011	MM	HC011
EUNOS	4IT 8+8	ORIGINAL		HC011		HC011
FIAT	2ITL 8	FT22U		HC044		HC044
	2ITR 7 LARGE	PG83U		HC030		HC030
FORD (AUSTRALIA)	2ETR 10	FD40U	MOMAX	HC011 or HC030	MOMAX	HC011 or HC030
FORD (EUROPE)	2ETR 10	FD40U	MOMAX	HC011 or HC030	MOMAX	HC011 or HC030
	2ITL 8	AD66U	MA	HC011 or HC030		HC011 or HC030
		FT22U		HC044		HC044
FORD (USA)	2ETR 7	FD40U	MOMAX	HC011 or HC030	MOMAX	HC011 or HC030
	2ETR 10	FD40U	MOMAX	HC011 or HC030	MOMAX	HC011 or HC030
GENESIS	4IT 4+3	TR49U		HC011		HC011
GMC	2ITR 8	VX5U		HC011		HC011
	2ITR 10	VX5U		HC011		HC011
HOLDEN	2ETR 10	VX3U	MOMAX	HC011	MOMAX	HC011
		VX4U	MOMAX	HC011	MOMAX	HC011
	2ITR 8	VX5U		HC011		HC011
HONDA	4ET 6+6	HD1U		HC011		HC011
	4IT 5+5	ORIGINAL		HC011		HC011
HYUNDAI	2ITL 8	HY21U		HC011		HC011
		ORIGINAL		HC011		HC011
		HY20U		HC011		HC011
	2ITR 8	ORIGINAL		HC011		HC011
	4IT 6+6	TR49U		HC011		HC011
JEEP	2ITL 8	FT22U		HC044		HC044
KIA	2ETL 7	ORIGINAL		HC011		HC011
	2ITL 8	ORIGINAL		HC011		HC011
	2ITR 8	ORIGINAL		HC011		HC011
	4IT 4+3	TR49U		HC011		HC011
	4IT 6+6	TR49U		HC011		HC011

# QUICK GUIDE TO LASER KEY SYSTEMS

303 / 304 / 305 / PUNTO | T-REX / T-REX ADVANCE  
CAR KEYS

MAKE	KEY SYSTEM	KL REFERENCE	303 / 304 / 305 / PUNTO		T-REX / T-REX ADVANCE	
			Adaptor	Cutter	Adaptor	Cutter
KIA	4IT 8+8	KI4		HC011		HC011
		TR49U		HC011		HC011
LANCIA	2ITL 8	FT22U		HC044		HC044
LAND ROVER	2ETR 10	FD40U	MOMAX	HC011 or HC030	MOMAX	HC011 or HC030
	2ITR 8	BM22P		HC011		HC011
	4ET 5+5	ORIGINAL		HC011		HC011
LEXUS	4IT 5+5	TR48U		HC011		HC011
	4IT 8+8	TR50P		HC011		HC011
LINCOLN	2ETR 10	FD40U	MOMAX	HC011 or HC030	MOMAX	HC011 or HC030
MAHINDRA	2ETR 10	FD40U	MOMAX	HC011 or HC030	MOMAX	HC011 or HC030
	2ITL 8	ORIGINAL		HC011		HC011
MAZDA	4IT 8+8	ORIGINAL		HC011		HC011
MERCEDES	2ET-R ROUND 10	MB54P	MM	HC011	MM	HC011
	2ETL FLAT 10	MB57P	MM	HC011	MM	HC011
	2ETL LONG 13	MB58P	MM	HC011	MM	HC011
	4ET 8+8	MB53P		HC011		HC011
MITSUBISHI	2ETR 8	VL15P		HC011		HC011
	4IT 8+8	TR49U		HC011		HC011
OPEL	2ETR 10	VX3U	MOMAX	HC011	MOMAX	HC011
	2ITR 8	VX5U		HC011		HC011
PEUGEOT	2ITL 6	PG33U		HC011		HC011
	2ITL 8	FT22U		HC044		HC044
	2ITR 7 LARGE	PG83U		HC030		HC030
	4ET 5+5	PG31U		HC011		HC011
	4IT-T THIN 6	PG33U		HC011		HC011
PORSCHE	2ITL 8	AD66U	MA	HC011 or HC030		HC011 or HC030
RAM	2ITL 8	FT22U		HC044		HC044
RANGE ROVER	2ETR 10	FD40AP	MOMAX	HC011 or HC030	MOMAX	HC011 or HC030
	4ET 5+5	ORIGINAL		HC011		HC011
RENAULT	2ITL 7	HY21U		HC011		HC011
	2ITR 6	PG33U		HC011		HC011
SAAB	2ETR 10	ORIGINAL		HC011		HC011
	2ITL 7	ORIGINAL		HC011		HC011
	2ITL 8	ORIGINAL		HC011		HC011
	2ITR 8	VX5U		HC011		HC011
SATURN	2ITR 8	VX5U		HC011		HC011
SEAT	2ITL 8	AD66U	MA	HC011 or HC030		HC011 or HC030
SMART	2ETR 8	ORIGINAL		HC011		HC011
	2ITL 6	PG33U		HC011		HC011
SSANGYONG	4IT 6+6	TR50P		HC011		HC011
SUBARU	4ET 5+5	SUB1U		HC011		HC011
TOYOTA	2ETR 10	VX4P		HC011		HC011
	2ITL 6	PG33U		HC011		HC011
	2ITL 8	ORIGINAL		HC011		HC011
	4IT 5+5	TR48U		HC011		HC011
	4IT 8+8	TR50P		HC011		HC011
VOLKSWAGEN	2ITL 8	HU163SU		HC023		HC023
		V66U	MA	HC011 or HC030		HC011 or HC030

# QUICK GUIDE TO LASER KEY SYSTEMS

## 303 / 304 / 305 / PUNTO | T-REX / T-REX ADVANCE CAR KEYS

MAKE	KEY SYSTEM	KL REFERENCE	303 / 304 / 305 / PUNTO		T-REX / T-REX ADVANCE	
			Adaptor	Cutter	Adaptor	Cutter
VOLKSWAGEN	2ITL 9+3+3	HU162U		HC023		HC023
VOLVO	2ETR 8	VL15P		HC011		HC011
		VL16P		HC011		HC011
		ORIGINAL		HC011		HC011
	2ETR 10	VL22P		HC011		HC011
	4ET 4+4	VL17P		HC011		HC011

## 303 / 304 / 305 / PUNTO | T-REX / T-REX ADVANCE MOTORCYCLE KEYS

MAKE	KEY SYSTEM	KL REFERENCE	303 / 304 / 305 / PUNTO		T-REX / T-REX ADVANCE	
			Adaptor	Cutter	Adaptor	Cutter
APRILIA	4IT 5+4	ZAD30U		HC011		HC011
BAJAJ	2ETR 8	FD40U	MOMAX	HC011 or HC030	MOMAX	HC011 or HC030
DUCATI	4IT 5+4	ZAD30U		HC011		HC011
GILERA	2ITL 8	FT22U		HC044		HC044
KTM	2ETR 8	FD40U	MOMAX	HC011 or HC030	MOMAX	HC011 or HC030
MOTO GUZZI	4IT 5+4	ZAD30U		HC011		HC011

**FRESE**

---

**CUTTERS**

---

**FRÄSER**

---

**FRAISES**

---

**FRESAS**

---



# CUTTERS

## SIGMA PRO / 993 POWER LYNX | 200 SERIES | FALCON | FOCUS

MOD.	REF.	D	F	S	P	No.	MAT.	TYPE	KCM
HS020	RIC01860B	63	16	1,4	1,4	80	HSS	L	201
HSSG1	RIC01858B	80	22	1,5	1,5	100	HSS	-	202 203 204
HSSG10	RIC01868B	80	22	2	2	100	HSS	-	202 203 204
HSSG12	RIC09113B	80	22	2,5	2,5	100	HSS	-	202 203 204 Falcon
HSSG2	RIC01872B	80	22	1,5	1,5	100	HSS	L	202 203 204
HSSG3	RIC01857B	80	22	1	1	100	HSS	-	202 203 204
HSSG30	RIC01866B	80	22	1,2	1,2	100	HSS	-	202 203 204
HSSG31	RIC01870B	80	22	2,4	2,4	100	HSS	-	202 203 204
HSSG32	RIC01733B	63	16	1,5	1,5	80	HSS	-	201
HSSG33	RIC01859B	63	16	2,4	2,4	64	HSS	-	201
HSSG35	RIC02133B	63	16	1,25	1,25	80	HSS	L	201
HSSG37	RIC02961B	76,2	19,05	2,4	2,4	120	HSS	-	Focus
HSSG38	RIC04294B	80	22	1,5	1,5	100	HSS	L	202 203 204
HSSG39	RIC04296B	80	22	1,25	1,25	100	HSS	L	202 203 204
HSSG4	RIC02663B	80	22	1,25	1,25	100	HSS	-	202 203 204
HSSG40	RIC04608B	63	16	1	1	80	HSS	-	201
HSSG41	RIC09893B	80	22	2,5	2,5	100	HSS	L	202 203 204 Falcon
HSSG6	RIC01864B	80	22	1,3	1,3	100	HSS	L	202 203 204 206
WSSG1	RIC01856B	80	22	1,5	1,5	100	W	-	202 203 204
WSSG36	RIC02865B	100	22	1,25	1,25	128	W	-	Sigma Pro / 993 Power Lynx
WSPL1	RIC03904B	100	22	1	1	128	W	-	Sigma Pro / 993 Power Lynx
WSPL1.25	RIC06716B	100	22	1,25	1,25	64	W	-	Sigma Pro / 993 Power Lynx
WSPL1.6	RIC06312B	100	22	1,6	1,6	128	W	-	Sigma Pro / 993 Power Lynx
WSPL1.8	RIC08408B	100	22	1,8	1,8	128	W	-	Sigma Pro / 993 Power Lynx
WSPL1.9	RIC09637B	100	22	1,9	1,9	128	W	-	Sigma Pro / 993 Power Lynx

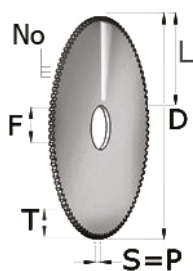

## OTHERS

MOD.	REF.	D	F	S	P	T	No.	MAT.	TYPE	KCM
WSSG32	RIC03910B	63	16	1,5	1,5	-	-	W	-	Halley Round*
WSPL1	RIC03904B	100	22	1	1	-	-	W	-	Idea* Prima Laser*
HSCU18	RIC03914B	32	12	1,35	1,35	-	-	HSS	-	Mizar*
HSSG18	RIC03902B	64,6	9,52	2,4	2,4	-	-	HSS	L	Delta AY* Delta FO*

\* Key Cutting machines not produced by Keyline available in the market.

\* Macchine duplicatrici non prodotte da Keyline presenti sul mercato.

\* Machines à reproduire les clés pas produites par Keyline disponibles dans le marché.

\* Nicht von Keyline hergestellte Schlüsselfraesmaschinen die auf dem Markt anwesend sind.

\* Maquinas duplicadoras no producidas de parte de Keyline disponibles en el mercado.



# CUTTERS

## DEZMO

MOD.	REF.	D	F	S	V°	I	P	No.	MAT.	KCM
F01	RIC08143B	80	16	5	80	0,15	0,5	80	W	Dezmo
F02	RIC08213B	80	16	5	80	0,15	0,5	50	W	Dezmo

## NINJA TOTAL | NINJA LASER | NINJA

MOD.	REF.	D	F	S	V°	I	P	No.	MAT.	KCM
HP034	RIC09167B	63	16	5	70	0,5	0,15	80	HSS	Ninja Total Ninja Laser Ninja
WP034	RIC09168B	63	16	5	70	0,5	0,15	80	W	Ninja Total Ninja Laser Ninja
WP034B	RIC09234B	63	16	5	70	0,5	0,15	40	W	Ninja Total Ninja Laser Ninja

## CARAT | 100 SERIES | ECO

MOD.	REF.	D	F	S	V°	I	P	No.	MAT.	KCM
HP005	RIC01721B	63	16	5	84	1,25	0,15	80	HSS	101
HP005S	RIC02102B	63	16	5	80	1,25	0,15	80	HSS	101
HPP01	RIC01720B	80	16	5	84	1,25	0,15	110	HSS	Carat 102 103 104
HPP01S	RIC02098B	80	16	5	80	1	0,15	110	HSS	Carat Easy 102 103 104 Euro Lupo
WP005	RIC01855B	63	16	5	84	1,25	0,15	80	W	101
WPP01	RIC01717B	80	16	5	84	1,25	0,15	100	W	Carat 102 103 104
WPP01S	RIC02106B	80	16	5	80	1	0,15	100	W	Carat 102 103 104
WPP24	RIC01826B	40	10	6	77,3	2,25	0,2	40	HSS	105
HPP032	RIC05808B	80	16	5	80	0,5	0,15	110	HSS	Carat
HPP033	RIC05810B	80	16	11	90	5,5	0,8	110	HSS	Carat
HP029	RIC02741B	75	10	5	80	1	0,15	100	HSS	Eco
HP030	RIC01967B	75	10	5	80	1	0,15	100	HSSC	Eco
HP031	RIC01969B	75	10	5	80	1	0,15	100	HSSPC	Eco

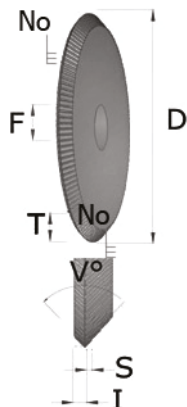

## OTHERS

MOD.	REF.	D	F	S	V°	I	P	No.	MAT.	KCM
HPP01U	RIC01971B	80	16	5	80	0,5	-	100	HSS	KD50*
HPP08	RIC03922B	40	8	5	42	-	-	-	HSS	Blitz*
HPP21	RIC04298B	60,4	9,52	5,25	84	0,5	0,15	70	HSS	Delta*
HPU01	RIC03906B	60,4	9,52	5,25	80	0,5	0,1	-	HSS	Unocode*

\* Key Cutting machines not produced by Keyline available in the market.

\* Macchine duplicatrici non prodotte da Keyline presenti sul mercato.

\* Machines à reproduire les clés pas produites par Keyline disponibles dans le marché.

\* Nicht von Keyline hergestellte Schluesselfraemaschinen die auf dem Markt anwesend sind.

\* Maquinas duplicadoras no producidas de parte de Keyline disponibles en el mercado.

# CUTTERS

## NINJA TOTAL | NINJA VORTEX | VERSA

MOD.	REF.	L	C	V	D	P	MAT.
V000	RIC05050B	32	-	60	4	0,1	W
V001	RIC05044B	32	4	90	4	0,4	W
V004	RIC05084B	32	4	82	4	0,5	W
V005	RIC05240B	32	4	80	4	0,4	W
V006	RIC05262B	32	4	96	4	0,4	W
V007	RIC05264B	32	4	100	4	0,4	W
V008	RIC05266B	32	4	106	4	0,6	W
V009	RIC05268B	32	4	108	4	0,6	W
V010	RIC05270B	32	4	110	4	0,3	W
V011	RIC05272B	32	4	120	4	0,3	W
V013	RIC05618B	32	4	90	4	0,7	W
V014	RIC05612B	32	4	90	4	0,6	W
V021	RIC06104B	32	3,2	90	4	0,8	W
V022	RIC06368B	32	2,7	90	4	0,8	W
V025	RIC06370B	32	4	104	4	0,4	W
V026	RIC06372B	32	4	105	4	0	W
V027	RIC06730B	32	4	100	4	0,8	W
V029	RIC06409B	32	-	-	-	-	W
V030	RIC06732B	32	-	-	-	-	W
V033	RIC07247B	32	3,6	90	4	1,6	W
V034	RIC07726B	32	3,2	120	4	0,8	W
V036	RIC07785B	32	4	87	4	0,5	W
V039	RIC08161B	32	6	95	4	1	W
V040	RIC08302B	32	8	96	4	1,20	W
V042	RIC09210B	32	4	30	4	1,60	W
V044	RIC09442B	32	4	90	4	0,20	W
V045	RIC09480B	32	4	105	4	1,20	W
V047	RIC10290B	32	2,6	97	4	0,60	W
V050	RIC10506B	32	4	78	4	1,2	W

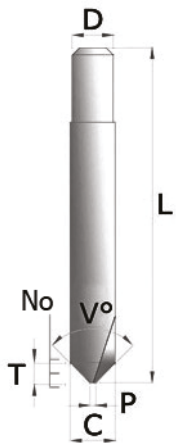

## T-REX | T-REX ADVANCE | PUNTO | 300 SERIES

MOD.	REF.	L	C	V	D	P	MAT.
HB001	RIC01791B	45	6	90	6	0,7	HSS
WB001	RIC08487B	45	6	90	6	0,7	W
HB005	RIC01775B	45	6	90	6	0,9	HSS
HB007	RIC01787B	45	6	72	6	0,8	HSS
HB012A	RIC01777B	45	-	100	6	0,6	HSS
HB012B	RIC01779B	45	8	96	8	2,8	HSS
HB015	RIC01781B	45	8	90	6	0,8	HSS
WB019	RIC08488B	45	-	90	6	0,56	W
HB020	RIC01793B	45	6	90	6	0,45	HSS
HB026	RIC01783B	45	6	82	6	0,8	HSS
HB037	RIC03964B	48	6	80	6	0,7	HSS
HB038	RIC03970B	48	6	80	6	0,8	HSS
HB039	RIC01785B	45	6	90	6	0,6	HSS
HB042	RIC01789B	45	6	100	6	0,7	HSS
HB043	RIC01822B	45	6	90	6	1	HSS
HB045A	RIC09770B	45	3,2	105	6	1,2	HSS
HB045B	RIC09771B	45	6	105	6	1,2	HSS

# CUTTERS

## NINJA TOTAL | NINJA VORTEX | VERSA

MOD.	REF.	T	L	D	P/C	MAT.
V002	RIC05046B	3,5	32	4	3	W
V003	RIC05048B	3,5	32	4	2,5	W
V012	RIC05274B	3,5	32	4	1,5	W
V015	RIC05614B	1,5	32	4	3,08	W
V016	RIC05616B	0,75	32	4	2,3	W
V017	RIC05508B	2,5/7	32	4	3	W
V018	RIC05506B	1,5	32	4	2,7	W
V020	RIC06102B	1	32	4	1,28	W
V023	RIC06508B	0,8	32	4	2,26	W
V024	RIC06116B	3	32	6	3	W
V031	RIC06734B	1	32	4	1,85	W
V035	RIC07782B	1	32	4	1,08	W
V037	RIC07786B	4	32	4	2	W
V038	RIC08166B	1	32	4	2,5	W
V041	RIC08315B	1	32	4	2	W
V043	RIC09211B	2	32	4	1,6	W
V046	RIC09666B	1,1	40	4	2,7	W

## NINJA LASER | 994 LASER

MOD.	REF.	T	L	D	P/C	MAT.
WC011A	RIC05304B	3,5	40	6	2,5	W
CL004	RIC08409B	6	43	6	1,5	W
CL005	RIC09617B	4	40	6	1,5	W

## T-REX | T-REX ADVANCE | PUNTO | 300 SERIES

MOD.	REF.	T	L	D	P/C	MAT.
HC003	RIC01820B	0,9	45	6	1,5	HSS
HC008	RIC03978B	12	48	6	4	HSS
HC011	RIC01810B	5	45	6	2,5	HSS
WC011	RIC08490B	5	45	6	2,5	W
HC023	RIC01812B	5	45	6	1,5	HSS
HC030	RIC01715B	6	45	6	3	HSS
HC044	RIC01816B	6	45	6	2	HSS
HC130	RIC08491B	3	45	6	1,3	HSS
HC131	RIC01818B	13	45	6	6	HSS
HC208	RIC01808B	5	42	6	2,4	HSS

## ARCADIA

MOD.	REF.	T	L	D	P/C	MAT.
	RIC08866B	12	36	6	5,95	HSS



**INDICE PER UTILIZZO**

---

**APPLICATION INDEX**

---

**VERWENDUNGSINDEX**

---

**INDEX DE UTILISATION**

---

**ÍNDICE DE APLICACIÓN**

---

# INDEX

REF.	PAG.	REF.	PAG.
<b>A</b>		FIAT (I)	172-173-174 175
ABLOY (S)	2-3-4	FICHET (F)	68
ABUS (D)	5-6-7-8-9-10-11	FORD (EU)	176-177-178 182-183
AGA (E)	12	FORD (EU) - FORD (USA)	179-180-181 184-185
AGB (I)	13-14	FTH (F)	69-258
ASSA (S)	15-16	<b>G</b>	
ASSA(S)	17-18	GE-GE (A)	70
ATRA (I)	19-20	GERA (D)	70
AUDI (D)	162-163	GIUSSANI (I)	71
AXA (NL)	21	GOAL (J)	71-72
AZBE (E)	22-23	<b>H</b>	
<b>B</b>		HOLDEN (AUS)	186-187
BASI (D)	23-24	HONDA (J)	188-189-190 191
BILMA (E)	255	HYUNDAI (J)	192
BKS (D)	25	<b>I</b>	
BMW (D)	164-165-166 167-168-169	ICSA (I)	72-73
BRICARD (F)	26-27	IFAM (E)	73-74
BRIDGESTONE (J)	27	INAHO (J)	74
BURG (D)	28	INFINITI (J)	193-194
<b>C</b>		ISEO (I)	75-76-77
CAVITH (F)	255	ITO (TR)	77-78
CES (D)	29-30	<b>J</b>	
CHIAVI A CROCE - CRUCIFORM KEYS	256	JAGUAR (GB)	195
CHIAVI A POMPA - PUMP KEYS	253	JIS (E)	78
CHIAVI A Y - Y KEYS	263	JPM (F)	258
CHIAVI FEMMINA - PIPE KEYS	252	<b>K</b>	
CHIAVI FERMO CENTRALE - MORTICE KEYS	250	KABA (CH)	79-80-81-82 83-84-85-86
CHIAVI FERMO POSTERIORE - BACK STOP BIT KEYS	248	KAKEN (J)	86-87
CHIAVI MAPPA - GERMANY KEYS	250	KALE (TR)	87-88
CHIAVI PER CASELLARI POSTALI (USA) - MAIL BOX KEYS (USA)	257	KESO (CH)	88-89-90
CHIAVI TUBOLARI - TUBULAR KEYS	261-262	KROMER (D)	249
CHUBB (GB)	30-31	KYR (I)	91
CISA (I)	31-32-33-34 35-36-37	<b>L</b>	
CITROEN (F)	170-171	LANCIA (I)	196-197
CITY (F)	37	LAPERCHE (F)	259
CODEM (F)	38	LEHMANN (D)	92
CORBIN (I)	38-39-40	LEXUS (J)	198-199-200
CORNI (I)	40	LINCE (E)	93
CVL (E)	41	LIPS (NL)	94-95-96
<b>D</b>		LUMA (E)	97
DAD-DECAYEUX (F)	257	<b>M</b>	
DE JONG	42	M&C (RO)	97-98
DEFEND LOCK (CZ)	42-43	MAGNUM (NL)	98-99
DELCA (GR)	43	MAUER (BG)	99-100
DIERRE (I)	44	MAZDA (J)	201-202
DOM (D)	44-45-46-48 49-50-51-52	MCM (E)	100-101
DOMUS (GR)	52-53	MEDECO (US)	102
<b>E</b>		MERCEDES (D)	203-204-205 206-207
ELZETT (H)	53	MERONI (I)	102-103
ESETY (I)	54	MG MONTI (I)	103-104-105
EURO-LOCKS (B)	55	MITSUBISHI (J)	208-209
EVVA (A)	56-57-58-59	MIWA (J)	106
EZCURRA (E)	60-61	MORI G. (I)	107
<b>F</b>		MOTTURA (I)	108-109
FAB (CZ)	62-63-64	MUL.T.LOCK (IL)	110-111
FAC (E)	64-65		
FAYN (TR)	65-66		
FCV (D)	66-67		
FIAM (I)	67-68-249		



# INDEX

REF.	PAG.	REF.	PAG.
<b>N</b>		WILKA (D)	150-151-152
NIKABA (J)	112	WINKHAUS (D)	152-153-154
NISSAN (J)	210		155
<b>O</b>		<b>Y</b>	
OMECA (I)	113-114	YALE (GB)	156
OPEL (D)	215-216	YARDENI (IL)	157-158
OPEL (D) - VAUXHALL (GB)	211-212-213	<b>Z</b>	
	214	ZADI (I)	159-245-246
<b>P</b>		ZEISS IKON (D)	160
PATENT	251		
PEUGEOT (F)	217-218-219		
	220-221-222		
	223-224		
PFAFFENHAIN (D)	115-116-117		
	118-119-120		
PICARDIE (F)	121		
POLLUX (F)	259-260		
POTENT (I)	121-122		
PREFER (I)	123-124		
PROGRES FONTAINE (F) - CORNI (I)	260-261		
<b>R</b>			
RENAULT (F)	225-226		
<b>S</b>			
SAAB (S)	226-227		
SANS SOUCI (F)	253		
SEA (CH)	125		
SEAT (E)	228-229		
SECUREMME (I)	126-127-128		
	129		
SECURITAL (I)	130		
SECURYSTAR (F)	129		
ŠKODA (CZ)	230-231		
SPIDER (IL)	131		
STS (E)	132-133		
STV (I)	134		
SUBARU (J)	232		
<b>T</b>			
TARONI (I)	135		
TESA (E)	136-137-138		
TESIO (I)	139		
TITAN (SLO)	140-141		
TOPEX (US)	141		
TOVER (E)	142-143-248		
TOYOTA (J)	233-234-235		
<b>U</b>			
UCEM (GB)	143-144		
UNION (GB)	144-145		
<b>V</b>			
VACHETTE (F)	146-147		
VIGIE PICARD (F)	263		
VIRO (I)	147-148-149		
VOLKSWAGEN (D)	236-237-238		
	239-240		
VOLVO (S)	241-242-243		
	244		
<b>W</b>			
WEST (J)	149-150		



Copyright by



*Innovators by design | Since 1770*

A BIANCHI 1770 GROUP COMPANY

Le illustrazioni e i dati tecnici dei prodotti contenuti nel catalogo debbono considerarsi indicativi.

Keyline si riserva di poter modificare i prodotti illustrati senza compromettere la loro funzionalità ed intercambiabilità al fine di migliorare la qualità del prodotto.

Tutti i disegni e le fotografie sono di proprietà di Keyline, ogni riproduzione anche parziale, senza autorizzazione scritta della Keyline è vietata secondo termini di legge.

Per qualsiasi controversia sono competenti gli Uffici Giudiziari dove ha sede l'Azienda, con espressa esclusione di qualsiasi altro foro.

All information and illustrations in this catalogue are for guidance only.

Keyline reserves the right to alter the illustrated products without compromising their functionality and interchangeability in order to improve the quality of the product itself.

The contents of this catalogue are fully protected by copyright and may not be copied or reproduced in any form without written permission from Keyline.

Any infringements will be dealt with under Italian law.

Die Abbildungen und technischen Daten des Katalogs sind nur zur Information.

Keyline behält sich vor, etwaige Änderungen am Produkt vorzunehmen ohne der Zweckmaessigkeit und Auswechselbarkeit zu gefaehrden um zur Verbesserung des Produkt.

Alle Zeichnungen und Fotos sind Besitz der Firma Keyline, jede Reproduktion, auch teilweise, ist ohne schriftliche Erlaubnis der Firma Keyline gesetzlich untersagt.

Im Falle von Streitfragen ist der Gerichtshof des Firmensitzes zuständig; jeder andere Gerichtshof ist ausgeschlossen.

Les illustrations et les caractéristiques techniques des produits présentés dans ce catalogue sont données à titre indicatif.

Keyline se réserve le droit d'apporter toutes les modifications des produits illustrés sans compromettre leur caractère fonctionnel et interchangeabilité pour améliorer la qualité du produit.

Tous les dessins et photos sont propriété Keyline et toute reproduction, même partielle, sans l'autorisation écrite préalable de Keyline est interdite conformément aux prescriptions légales.

Tout litige est du ressort exclusif des Tribunaux de la circonscription où se trouve le Siège de la Société.

Las ilustraciones y los datos técnicos de los productos en este catálogo son indicativos.

Keyline se reserva el derecho de modificar los productos ilustrados sin comprometer la funcionalidad e intercambiabilidad para mejorar la calidad del producto.

Todos los dibujos y las fotografías pertenecen a la Keyline; se prohíbe toda reproducción aunque parcial, sin autorización por escrito de la Keyline.

En caso de disputas la competencia es de las autoridades judiciales donde está domiciliada la firma, excluyendo cualquier otro foro.

To find the distributor closest to your company,  
please send a request to:



#### Keyline

Keyline S.p.A.  
Via Camillo Bianchi, 2 - P.O. Box 251  
31015 Conegliano (TV) Italy  
T +39 0438 202 511  
F +39 0438 202 520  
info@keyline.it  
www.keyline.it



#### Bianchi 1770 Group Companies distributing Keyline products

##### Keyline USA

Bianchi USA, Inc.  
31336 Industrial Pkwy - Suite 3  
North Olmsted, Ohio 44070, USA  
T +1 440 716 8006  
F +1 216 803 0202  
TF +1 800 891 2118  
info@keyline-usa.com  
www.keyline-usa.com

##### Keyline Italia

Keyline Italia S.r.l.  
Via Zoe Fontana, 220 - Ed. C  
Tecnocittà  
00131 Roma, Italy  
T +39 06 4122 9822  
F +39 06 4120 0981  
info@keyline-italia.it  
www.keyline-italia.it

##### Keyline Shanghai

Bianchi 1770 Hardware Technology (Shanghai) Co. Ltd  
比安奇五金技术（上海）有限公司  
中国上海市虹口区黄浦路99号  
上海滩国际大厦1505室  
Room 1505, Shanghai Bund International Tower  
No.99 Huangpu Road, Hong Kou District 200080  
Shanghai P.R. China  
T +86 021 5031 0980  
F +86 021 5031 0981  
info@keyline-shanghai.com  
www.keyline-shanghai.com

##### Keyline Germany

Keyline GmbH  
Uhlandstraße 31b  
42549 Velbert, Germany  
T +49 (0) 2051 807 4444  
F +49 (0) 2051 606 9922  
info@keyline-germany.de  
www.keyline-germany.de

#### Bianchi 1770 Group Representative Offices coordinating onsite distributors

##### Keyline UK

18 Beeston Court - Stuart Road  
Manor Park - Runcorn - Cheshire  
WA7 1SS - UK  
T +44 (0) 1928 571 167  
F +44 (0) 1928 579 595  
info@keyline-uk.co.uk  
www.keyline-uk.co.uk

##### Keyline Japan

〒532-0011  
大阪府大阪市淀川区西中島4-7-20  
日宝新大阪第1ビル4階1号  
Room 4F-1 Nippo Shin-Osaka Daiich Building  
4-7-20 Nishinakajima, Yodogawa-ku Osaka City  
Osaka 532-0011, Japan  
T +81 6 4805 6969  
F +81 6 4805 6900  
info@keyline-japan.jp  
www.keyline-japan.jp



ISO TS 16949 CERTIFIED COMPANY -  
IATF CERTIFICATE N.0248044

